

HP 8642A/B
SYNTHESIZED SIGNAL GENERATOR
OPERATION AND CALIBRATION MANUAL
(Including Options 001, 002 and 003)

VOLUME 1

SERIAL NUMBERS

This manual applies directly to instruments with serial numbers prefixed:

2427A to 2734A

rev. 10SEP87

For additional important information about serial numbers, refer to "INSTRUMENTS COVERED BY THIS MANUAL" in Section I.

©HEWLETT-PACKARD COMPANY 1985
EAST 24001 MISSION AVENUE, TAF C-34, SPOKANE, WASHINGTON, U.S.A. 99220

Operation/Calibration Manual Part No. 08642-90224

Other Documents Available:

Microfiche Operation/Calibration Manual Part Number (Volume 1) 08642-90225

Service Manual Part Number (Volume 2, 3, 4) 08642-90226

Microfiche Service Manual Part No. 08642-90227

Printed in the USA: JANUARY 1985



DIGITALLY REMASTERED
OUT OF PRINT
HEWLETT PACKARD MANUAL SCANS

By

ArtekManuals

(formerly known as ArtekMedia and Artekmedia.com)
7102 VALRIE LANE, RIVERVIEW, FL 33569

www.artekmanuals.com

“High resolution scans of obsolete technical manuals”

ALL HEWLETT PACKARD/ AGILENT/ KEYSIGHT MANAULS ARE REPRODUCED BY PERMISSION AND UNDER LICENSE AGREEMENT WITH AGILENT TECHNOLOGIES, INC.,2005. REMOVAL OF THIS DISCLAIMER IS INVIOATION OF AGILENT TECHNOLOGIES AND ARTEK MEDIA'S COPYRIGHTS. DUPLICATION OR MODIFCATION OF THIS DIGITAL DOCUMENT WITHOUT PRIOR CONSENT IS NOT PERMITTED

If your looking for a quality scanned technical manual in PDF format please visit our WEB site at www.artekmanuals.com or drop us an email at Manuals@artekmanuals.com

If you don't see the manual you need on the list drop us a line anyway we may still be able to point you to other sources. If you have an existing manual you would like scanned please write for details. This can often be done very reasonably in consideration for adding your manual to our library.

Typically the scans in our manuals are done as follows;

- 1) Typed text pages are typically scanned in black and white at 300 dpi.
- 2) Photo pages are typically scanned in gray scale mode at 600 dpi
- 3) Schematic diagram pages are typically scanned in black and white at 600 dpi or Gray-scale @450dpi depending on the characteristics.
- 4) All manuals are text searchable and all manuals are fully bookmarked

All data is guaranteed for life (yours or mine ... which ever is shorter). If for ANY REASON your file becomes corrupted, deleted or lost, ArtekManuals will replace the file for the price of shipping, or free via FTP download.

Thanks



"DC" Henderson
Founder and CEO
Artek Media
ArtekManuals
Outsource-Options

CERTIFICATION

Hewlett-Packard Company certifies that this product met its published specifications at the time of shipment from the factory. Hewlett-Packard further certifies that its calibration measurements are traceable to the United States National Bureau of Standards, to the extent allowed by the Bureau's calibration facility, and to the calibration facilities of other International Standards Organization members.

WARRANTY

This Hewlett-Packard instrument product is warranted against defects in material and workmanship for a period of one year from date of shipment. During the warranty period, Hewlett-Packard Company will at its option, either repair or replace products which prove to be defective.

For warranty service or repair, this product must be returned to a service facility designated by HP. Buyer shall prepay shipping charges to HP and HP shall pay shipping charges to return the product to Buyer. However, Buyer shall pay all shipping charges, duties, and taxes for products returned to HP from another country.

HP warrants that its software and firmware designated by HP for use with an instrument will execute its programming instructions when properly installed on that instrument. HP does not warrant that the operation of the instrument, or software, or firmware will be uninterrupted or error free.

LIMITATION OF WARRANTY

The foregoing warranty shall not apply to defects resulting from improper or inadequate maintenance by Buyer, Buyer-supplied software or interfacing, unauthorized modification or misuse, operation outside of the environmental specifications for the product, or improper site preparation or maintenance.

NO OTHER WARRANTY IS EXPRESSED OR IMPLIED. HP SPECIFICALLY DISCLAIMS THE IMPLIED WARRANTIES OF MERCHANTABILITY AND FITNESS FOR A PARTICULAR PURPOSE.

EXCLUSIVE REMEDIES

THE REMEDIES PROVIDED HEREIN ARE BUYER'S SOLE AND EXCLUSIVE REMEDIES. HP SHALL NOT BE LIABLE FOR ANY DIRECT, INDIRECT, SPECIAL, INCIDENTAL, OR CONSEQUENTIAL DAMAGES, WHETHER BASED ON CONTRACT, TORT, OR ANY OTHER LEGAL THEORY.

ASSISTANCE

Product maintenance agreements and other customer assistance agreements are available for Hewlett-Packard products.

For any assistance, contact your nearest Hewlett-Packard Sales and Service Office. Addresses are provided at the back of this manual.

SAFETY CONSIDERATIONS

GENERAL

This product and related documentation must be reviewed for familiarization with safety markings and instructions before operation.

This product is a Safety Class I instrument (provided with a protective earth terminal).

BEFORE APPLYING POWER

Verify that the product is set to match the available line voltage and the correct fuse is installed.

SAFETY EARTH GROUND

An uninterruptible safety earth ground must be provided from the main power source to the product input wiring terminals, power cord, or supplied power cord set.

SAFETY SYMBOLS

 Instruction manual symbol: the product will be marked with this symbol when it is necessary for the user to refer to the instruction manual (refer to Table of Contents).

 Indicates hazardous voltages.

 Indicates earth (ground) terminal.

WARNING The WARNING sign denotes a hazard. It calls attention to a procedure, practice, or the like, which, if not correctly performed or adhered to, could result in personal injury. Do not proceed beyond a WARNING sign until the indicated conditions are fully understood and met.

CAUTION The CAUTION sign denotes a hazard. It calls attention to an operating procedure, practice, or the like, which, if not correctly performed or adhered to, could result in damage to or destruction of part or all of the product. Do not proceed beyond a CAUTION sign until the indicated conditions are fully understood and met.

WARNING

Any interruption of the protective (grounding) conductor (inside or outside the instrument) or disconnecting the protective earth terminal will cause a potential shock hazard that could result in personal injury. (Grounding one conductor of a two conductor outlet is not sufficient protection).

Whenever it is likely that the protection has been impaired, the instrument must be made inoperative and be secured against any unintended operation.

If this instrument is to be energized via an autotransformer (for voltage reduction) make sure the common terminal is connected to the earth terminal of the power source.

Servicing instructions are for use by service-trained personnel only. To avoid dangerous electric shock, do not perform any servicing unless qualified to do so.

Adjustments described in the manual are performed with power supplied to the instrument while protective covers are removed. Energy available at many points may, if contacted, result in personal injury.

Capacitors inside the instrument may still be charged even if the instrument has been disconnected from its source of supply.

For continued protection against fire hazard, replace the line fuse(s) only with 250V fuse(s) of the same current rating and type (for example, normal blow, time delay, etc.). Do not use repaired fuses or short circuited fuseholders.

TABLE OF CONTENTS

Section I GENERAL INFORMATION	Section III OPERATION
Introduction to the Operating and Service Manual	Introduction to Section III
Volume I, Operating Manual	Operating Information
Volumes II through IV, Service Manual	HP-IB Table of Contents
Where to Find Instrument Specifications	HP-IB Remote Operation
Where to Find Safety Considerations	HP-IB Address
Hewlett-Packard Interface Bus (HP-IB) Enables	HP-IB Capabilities
Remote Control of the Instrument	Data Input
Selecting the HP-IB Address	Data Output
HP-IB Capabilities	Clear
An Explanation of the On-Site Service Strategy	Remote, Local
Hardware Features	Local Lockout, Set Local
Built-In Test Features	Service Request
Firmware Features	Status Byte
Quick Reference Manual Information	Additional HP-IB Information
How the Operating Fundamentals Can Help You	HP-IB Codes Summary
Learn to Operate the Instrument	HP-IB Related Front-Panel Keys
Accessories Supplied With the 8642A/B	HP-IB Related Terms
Options Available With the Instrument	RF Frequency
Electrical Options	RF Frequency Contents
Mechanical Options	RF Frequency
Documentation Options	Relative RF Frequency
Equipment That Can Be Ordered for the Signal	RF Frequency Sweep
Generator	Amplitude
On-Site Service Kits	Amplitude Contents
Bench Service Kit	Amplitude
Signal Generator Test System, HP 8952S	Relative Amplitude
50 Ohm to 75 Ohm Adapter	Amplitude Sweep
Fiberglass Transit Case	Modulation
Rack-Slide Kit	Modulation Contents
How to Use the Recommended Test Equipment	Modulation, AM
Table	Modulation, FM
Instruments Covered By This Manual	Modulation, Φ M
	Modulation, Pulse
	Modulation Oscillator
	Setting Modifications
	Setting Modifications Contents
	Instrument Preset, Partial Preset
	Knob
	Step, Increment Set
	Entry Off
	Recall Registers
	Recall Registers Contents
	Save/Recall
	Sequence
	Special Functions
	Special Functions Contents
	Special Functions
	Messages
	Messages Contents
	Operating Messages
	Appendixes
	Appendix A: Glossary
	Appendix B: Writing Messages to the Display
	Appendix C: Amplitude Units Conversion
	Appendix D: Display Annunciators and
	Abbreviations
	Appendix E: Individual Instrument
	Identification

Section II INSTALLATION

Introduction	2-1
Initial Inspection	2-1
Preparation for Use	2-1
Power Requirements	2-1
Power Cables	2-3
HP-IB Address Selection	2-5
Interconnections	2-5
Mating Connectors	2-5
Operating Environment	2-5
Rack Mounting	2-5
Storage and Shipment	2-6
Environment	2-6
Packaging	2-6

CONTENTS

SECTION 4 PERFORMANCE TESTS

Introduction	4-3
Recommended Test Equipment	4-3
Test Record	4-3
Abbreviated Performance Testing	4-4
Level Accuracy and Flatness Tests	4-6
Harmonics Tests	4-12
Pulse On/Off Ratio Test	4-14
Residuals Tests	4-16
AM, FM, and Φ M Tests	4-18
Extended FM Distortion Test	4-25
Internal Modulation Oscillator Tests	4-27
SWR	4-30
Spurious Test	4-35
Third Order Intermodulation	4-37
SSB Phase Noise Test	4-39
SSB Phase Noise Test (Optional)	4-42
Extended Pulse Tests	4-46
Optional Residual FM Test	4-49
Internal Time Base Aging Rate Test	4-51

SECTION 5 ADJUSTMENTS

Adjustments	5-2
Auto-Adjust Routines	5-2
Description	5-2
How All Auto-Adjust Procedures Begin	5-3
Correction Data Special Functions	5-5
Identifying the Contents of A20	5-5
Identifying the Contents of A3	5-7
Interpreting Cal Data Stats	5-8

SECTION I

GENERAL INFORMATION

1-1. INTRODUCTION TO THE OPERATING AND SERVICE MANUAL

This manual contains information required for a qualified person to install, operate, test, adjust, and service the Hewlett-Packard Model 8642A/B Signal Generator. The HP Model 8642A/B will generally be referred to as the Signal Generator throughout the manual. The Operating and Service Manual is comprised of four volumes as described below.

Volume I, Operating Manual

Operating Fundamentals. This booklet provides operating exercises to enable you to easily operate the instrument's basic functions.

Section I, General Information. General Information covers instrument specifications, options, equipment available, recommended test equipment, and an explanation of the On-Site Service Strategy for the HP 8642A/B.

Section II, Installation. Installation covers initial inspection, preparation for use, and storage and shipment.

Section III, Operation. Operation provides HP-IB operating information (including HP-IB address selection) and detailed operating information for either the beginning or experienced user. A glossary and index are provided at the end of Section III.

Volumes II Through IV, Service Manual

Section IV, Performance Tests. Performance Tests enable you to check the performance of the instrument against the specifications listed in Table 1-1.

Section V, Adjustments. The adjustment procedures that are normally found in this section are now located in Section VIII with the appropriate troubleshooting procedures and schematics.

Section VI, Replaceable Parts. Replaceable Parts lists all replaceable parts and assemblies.

Section VII, Instrument Changes. Instrument changes provide backdating information, and retrofitting and modification information.

Section VIII, Service. Service provides the information required to adjust and repair the instrument.

1-2. WHERE TO FIND INSTRUMENT SPECIFICATIONS

Instrument specifications are listed in Table 1-1 (page 1-7). These specifications are the performance standards or limits against which the instrument can be tested. Supplemental characteristics are listed in Table 1-2 (page 1-13). Supplemental characteristics are not guaranteed specifications but are typical characteristics included as additional information.

1-3. WHERE TO FIND SAFETY CONSIDERATIONS

This product is a Safety Class I instrument; that is, one provided with a protective earth terminal. Before operating or servicing the Signal Generator, service personnel should familiarize themselves with the safety markings on the Signal Generator and the safety instructions. Safety information pertinent to the task at hand (that is, information regarding installing, operating, performance testing, adjusting, or servicing the HP 8642A/B) is found throughout this manual. Refer to the Safety Considerations pages found at the beginning of Volume I for a summary of that information.

1-4. HEWLETT-PACKARD INTERFACE BUS (HP-IB) ENABLES REMOTE CONTROL OF THE INSTRUMENT

The HP 8642A/B Signal Generator has a Hewlett-Packard Interface Bus (HP-IB) interface and can be used with an HP-IB compatible controller for test system applications. The Signal Generator is fully programmable via the HP Interface Bus. HP-IB is Hewlett-Packard's implementation of IEEE Standard 488 and the identical ANSI Standard MC1.1. (Refer to the HP-IB portion of Section III for more complete details.)

Selecting the HP-IB Address

The Signal Generator's HP-IB address is set to 19 at the factory in both internal memory and an internal switch located inside the instrument. The decimal equivalent of the 5-bit address code can be displayed on and changed from the front panel. Refer to **HP-IB Address** in the HP-IB portion of Section III for information regarding changing the HP-IB address.

HP-IB Capabilities

This Signal Generator's HP-IB capabilities are defined by the following list of interface functions. For more information, refer to page 3-9.

Source Handshake	SH1	(Complete capability)
Acceptor Handshake	AH1	(Complete capability)
Talker	T6	(No talk only mode)
Extended Talker	TE0	(No capability)
Listener	L3	(Complete capability including Listen Only)
Extended Listener	LE0	(No capability)
Service Request	SR1	(Complete capability)
Remote Local	RL1	(Complete capability)
Parallel Poll	PP0	(No capability)
Device Clear	DC1	(Complete capability)
Device Trigger	DT0	(No capability)
Controller	C1	(System controller)
	C2	(Send IFC and take charge)
	C3	(Send REN)
	C28	(Send interface messages)
Driver Electronics	E2	(Three-state drivers)

1-5. AN EXPLANATION OF THE ON-SITE SERVICE STRATEGY

The objectives of the on-site service strategy are to provide the equipment and information necessary to enable service-trained personnel to troubleshoot and repair the HP 8642A/B to the module level at its operating site. Using the On-Site Service Kit (refer to paragraph 1-12 for a description), a service person should be able to successfully repair 80% or more of Signal Generator failures within two hours after arriving at the operating site. Repair times may be longer for individuals with no prior training or experience on the HP 8642A/B.

The following service features have been designed into the HP 8642A/B:

Hardware Features

- Each major circuit function is physically located in a separate module.
- RF modules are arranged physically from left to right in the order of their functional sequence.
- Most intermodule connections are accessible from the top of the instrument.
- There are no RF feedback paths between modules (a feed-forward design).
- Printed on the inside top cover of the instrument is an illustrated top view of the inside of the instrument as well as a table of cable connections.

Built-In Test Features

- A voltmeter and a power meter are built into the instrument.
- Unique service tools are stored inside the HP 8642A/B cabinet.

Firmware Features

- All RF modules are connected to a diagnostic bus which allows the controller to monitor critical operating test points within the module.
- Critical message information concerning the operating condition of the HP 8642A/B is displayed in numeric code on the front panel (or can be printed via an HP-IB printer without the need of an external controller).
- Four instrument diagnostic levels help to analyze the instrument's condition: Power-Up Self-Check, Fault Detection Self-Check, Instrument Level Diagnostics, and Module Level Diagnostics.

1-7. HOW THE OPERATING FUNDAMENTALS CAN HELP YOU LEARN TO OPERATE THE INSTRUMENT

The Operating Fundamentals are abbreviated, front-panel operating instructions (included with Volume I as a separate booklet) which will enable you to operate the basic functions of the Signal Generator without using the more detailed and extensive portions of the Operating Manual. However, the Detailed Operating Instructions in Section III can provide more specific information, which can be easily accessed with an Index.

1-8. ACCESSORIES SUPPLIED WITH THE 8642A/B

The line power cable is the only accessory supplied with the Signal Generator. The line power cable is selected at the factory according to the line power requirements specified by the customer. If the line power cord type is not specified, it will be selected according to the voltage available in the country of destination. For the part numbers of the power cables, refer to Table 2-1 on page 2-4, Power Cable and Mains Plug Part Numbers. Signal Generators shipped to countries using 115 volts are also supplied with a set of fuses for 230 volt operation.

1-9. OPTIONS AVAILABLE WITH THE INSTRUMENT

Electrical Options

Electrical option numbers can be displayed on the front panel or read via HP-IB. Refer to page 3-208.1 for more information.

Option 001 (High Stability Time Base). This optional time base improves the frequency accuracy and stability of the internal reference oscillator. (Refer to Table 1-1 for specifications.)

Option 002 (Rear-Panel Output for All Connectors). This option places all front-panel connections on the rear panel of the instrument.

8642A Option 003 (Increased Output Power Option). This option enables the HP 8642A Synthesized Signal Generator to deliver the same output power as the 8642B (excluding band 10).

Mechanical Options

Option 907 (Front-Handle Kit). Front handles are provided when Option 907 is ordered. Order a Front-Handle Kit as HP part number 5061-0089.

Option 908 (Rack-Flange Kit). Rack flanges are provided for the Signal Generator when Option 908 is ordered. (When rack mounting the Signal Generator, ensure the instrument is supported properly by using the system cabinet's support rails. Due to the weight of the HP 8642A/B, not using the support rails could cause damage to the instrument and/or the system cabinet.) Order a Rack-Flange Kit as HP part number 5061-0077.

Option 909 (Rack-Flange and Front-Handle Combination Kit). This is not a Front-Handle Kit and a Rack-Flange Kit packaged together; it is a unique part that combines both functions. Combination kits are provided for the Signal Generator when Option 909 is ordered. (When rack mounting the Signal Generator, ensure the instrument is supported properly by using the system cabinet's support rails. Due to the weight of the HP 8642A/B, not using the support rails could cause damage to the instrument and/or the system cabinet.) Order a Rack-Flange and Front-Handle Combination Kit as HP part number 5061-0083.

Rack-Slide Kit information is listed on the following page under paragraph 1-10, Equipment That Can Be Ordered for the Signal Generator. If you are planning to take advantage of the On-Site Service Strategy for the HP 8642A/B, we suggest you use the Rack-Slide Kit when rack mounting the instrument.

Documentation Options

Option 910 (Extra Manual). This option provides an additional Operating and Service Manual (Volumes I through IV). Order the additional manual as HP part number 08642-90012.

Option 914 (Delete Service Manual). This option provides only an Operating Manual (Volume I) with the Signal Generator. Order an Operating Manual as HP Part Number 08642-90013.

Option 710 (On-Site Service Manual). The On-Site Service Manual is a service tool directed at speedy troubleshooting and repair of the HP 8642A/B to the module level. The manual provides a systematic approach to troubleshooting which directs the technician through instrument checks, module-group checks, and then specific module checks. The On-Site Service Manual is designed for use with the On-Site Service Kits. (Refer to paragraph 1-10 below.) Order the On-Site Service Manual as HP part number 08642-90020. (It is not necessary to order option 710 if an On-Site Service Kit is ordered.)

1-10. EQUIPMENT THAT CAN BE ORDERED FOR THE SIGNAL GENERATOR

On-Site Service Kits

Each of these kits contains an On-Site Service Manual in addition to all HP 8642A/B modules and interconnecting cables required for on-site, module-level repair. Each kit also includes a set of tools (not normally found in a standard tool box) necessary to service the HP 8642A/B. Order the HP 11801A to service the HP 8642A. Order the HP 11801B to service the HP 8642B. Order the HP 11801C to service both instruments. Refer to Table 1-5, on page 1-17, for a complete parts listing of the On-Site Service Kit. (Although two part numbers are listed for modules in the On-Site Service Kit, only the new or the restored module will be included in the kit.)

Bench Service Kit

This kit, in conjunction with the HP 8642A/B Service Manual, is directed at component-level repair and module calibration of the HP 8642A/B. The kit contains special tools and troubleshooting aids such as a Torx torque wrench and Torx bits, test adapters, and special cables and cable adapters, etc. Order the Bench Service Kit as HP part number 11802A. Refer to Figure 1-2 on page 1-19 for a complete parts listing of the Bench Service Kit.

Signal Generator Test System, HP 8952S

This test system provides the necessary equipment for automated performance testing of the HP 8642A/B. One of the following software options is required to operate the test set. Software Pac: HP 11795 Opt. 205 (for the HP 8642A) or HP 11795 Opt. 206 (for the HP 8642B).

50 Ohm to 75 Ohm Adapter

This adapter is an impedance-matching network required for testing with 75 ohm cabling and/or loads. Order the adapter with HP part number 11687A.

Fiberglass Transit Case

Order this protective case for shipping and transporting the HP 8642A/B Signal Generator as HP part number 9211-2661.

Rack-Slide Kit

This heavy-duty, rack-slide kit is the kit recommended for the HP 8642A/B Signal Generator. Order the Rack-Slide Kit for instrument cabinet frames assembled with metric hardware as HP part number 08642-80059. Order the Rack-Slide Kit for instrument cabinet frames assembled with English hardware as HP part number 08642-80058. (Note that if metric hardware is used, the rear panel of the instrument mentions that fact.)

1-11. HOW TO USE THE RECOMMENDED TEST EQUIPMENT TABLE

Table 1-3 (page 1-15) lists the test equipment required for testing, adjusting, and servicing the Signal Generator. The critical specification column describes the essential requirements for each piece of test equipment. Other equipment can be substituted if it meets or exceeds these critical specifications.

Alternate models are suggested in Table 1-4 on page 1-16. Some reasons for recommending an alternate model might be its HP-IB compatibility or its ability to replace two or more single models.

1-12. INSTRUMENTS COVERED BY THIS MANUAL

Serial Numbers. Attached to the instrument is a serial-number plate. The serial number is in the form: 0000A00000. The first four digits and the letter are the serial prefix. The last five digits form the suffix that is unique to each instrument. The contents of this manual apply directly to instruments having the same serial prefix(es) as those listed at the beginning of Volume I.

Manual Updates. An instrument manufactured after the printing of this manual may have a serial prefix that is not listed at the beginning of Volume I. An unlisted serial prefix number indicates that the instrument differs in some way from those documented in this manual.

A "MANUAL UPDATES" packet is shipped with the manual when necessary to provide you with the most current information available at the time of shipment. These packets consist of replacement and addition pages which should be incorporated into the manual to bring it up to date.

Hewlett-Packard offers a **Documentation Update Service** that will provide you with further updates as they become available.

If you operate or service instruments of different serial prefixes, we strongly recommend that you join this service immediately to ensure that your manual is kept current. For more information refer to the **Documentation Update Service** reply card included with this manual or contact:

Hewlett-Packard Company
Spokane Division
Technical Writing Department
24001 E. Mission -- TAF C-34
Spokane, WA 99220

(509) 922-4001

Table 1-1. Specifications (1 of 6)

Electrical Characteristics	Performance Limits	Conditions																																				
<p>FREQUENCY</p> <p>Range</p> <p>8642A 8642B</p> <p>Carrier Frequency</p> <p>Band¹</p> <p>10 (8642B only) 9 8 7 6 5 4 3 2 1 HET</p> <p>Resolution</p> <p>Stability</p>	<p>100 kHz to 1057.5 MHz 100 kHz to 2115 MHz</p> <p>1057.500001–2115.000000 MHz 528.750001–1057.500000 MHz² 264.375001– 528.750000 MHz 132.187501– 264.375000 MHz 66.093751– 132.187500 MHz 33.046876– 66.093750 MHz 16.523438– 33.046875 MHz 8.261719– 16.523437 MHz 4.130860– 8.261718 MHz 0.100000– 4.130859 MHz 0.100000– 132.187500 MHz</p> <p>1 Hz (0.1 Hz with Special Function 240 or 241)</p> <p>Same as reference oscillator</p>																																					
<p>INTERNAL REFERENCE OSCILLATOR</p> <p>Standard Option 001 Aging Rate</p>	<p>See Supplemental Characteristics <10⁻⁹/day</p>	<p>After 8-day warm-up</p>																																				
<p>SPECTRAL PURITY</p> <p>SSB Phase Noise</p> <p>Band</p> <p>10 9 8 7 6 5 4 3 2 1 HET</p>	<table border="0"> <thead> <tr> <th></th> <th><u>SSB Phase Noise, 20 kHz offset from carrier</u></th> <th><u>SSB Phase Noise Floor, 200 kHz offset from carrier</u></th> </tr> </thead> <tbody> <tr> <td>10</td> <td>-125 dBc/Hz</td> <td>-134 dBc/Hz</td> </tr> <tr> <td>9</td> <td>-134 dBc/Hz</td> <td>-143 dBc/Hz</td> </tr> <tr> <td>8</td> <td>-137 dBc/Hz</td> <td>-144 dBc/Hz</td> </tr> <tr> <td>7</td> <td>-141 dBc/Hz</td> <td>-144 dBc/Hz</td> </tr> <tr> <td>6</td> <td>-144 dBc/Hz</td> <td>-145 dBc/Hz</td> </tr> <tr> <td>5</td> <td>-145 dBc/Hz</td> <td>-145 dBc/Hz</td> </tr> <tr> <td>4</td> <td>-146 dBc/Hz</td> <td>-147 dBc/Hz</td> </tr> <tr> <td>3</td> <td>-147 dBc/Hz</td> <td>-148 dBc/Hz</td> </tr> <tr> <td>2</td> <td>-148 dBc/Hz</td> <td>-149 dBc/Hz</td> </tr> <tr> <td>1</td> <td>-137 dBc/Hz</td> <td>-138 dBc/Hz</td> </tr> <tr> <td>HET</td> <td>-125 dBc/Hz</td> <td>-137 dBc/Hz</td> </tr> </tbody> </table>		<u>SSB Phase Noise, 20 kHz offset from carrier</u>	<u>SSB Phase Noise Floor, 200 kHz offset from carrier</u>	10	-125 dBc/Hz	-134 dBc/Hz	9	-134 dBc/Hz	-143 dBc/Hz	8	-137 dBc/Hz	-144 dBc/Hz	7	-141 dBc/Hz	-144 dBc/Hz	6	-144 dBc/Hz	-145 dBc/Hz	5	-145 dBc/Hz	-145 dBc/Hz	4	-146 dBc/Hz	-147 dBc/Hz	3	-147 dBc/Hz	-148 dBc/Hz	2	-148 dBc/Hz	-149 dBc/Hz	1	-137 dBc/Hz	-138 dBc/Hz	HET	-125 dBc/Hz	-137 dBc/Hz	<p>CW, AM, or Angle Modulation <1/60 Maximum Peak Deviation</p>
	<u>SSB Phase Noise, 20 kHz offset from carrier</u>	<u>SSB Phase Noise Floor, 200 kHz offset from carrier</u>																																				
10	-125 dBc/Hz	-134 dBc/Hz																																				
9	-134 dBc/Hz	-143 dBc/Hz																																				
8	-137 dBc/Hz	-144 dBc/Hz																																				
7	-141 dBc/Hz	-144 dBc/Hz																																				
6	-144 dBc/Hz	-145 dBc/Hz																																				
5	-145 dBc/Hz	-145 dBc/Hz																																				
4	-146 dBc/Hz	-147 dBc/Hz																																				
3	-147 dBc/Hz	-148 dBc/Hz																																				
2	-148 dBc/Hz	-149 dBc/Hz																																				
1	-137 dBc/Hz	-138 dBc/Hz																																				
HET	-125 dBc/Hz	-137 dBc/Hz																																				
<p>¹Both generators cover their ranges in one continuous span. However, many other specifications are dependent on carrier frequency. To simplify such specifications, the 8642A and 8642B carrier frequency ranges are divided into bands.</p> <p>²Band 9, 8642B carrier frequency range is 528.7500005 MHz to 1057.500000 MHz</p>																																						

Table 1-1. Specifications (2 of 6)

Electrical Characteristics	Performance Limits	Conditions
SPECTRAL PURITY (Cont'd)		
Residual FM		CW, AM, or Angle Modulation ≤ 1/3 Maximum Peak Deviation
	Post Detection Bandwidth	
Band	0.3 to 3.0 kHz	0.05 to 15.00 kHz
10 (8642B only)	<5 Hz rms	<9 Hz rms
9	<2 Hz rms	<5 Hz rms
8	<1.2 Hz rms	<2 Hz rms
1-7	<1 Hz rms	<1.2 Hz rms
HET	<3.5 Hz rms	<5 Hz rms
Residual AM	<0.01% AM rms	0.3 to 3.0 kHz Post Detection Bandwidth
Spurious Output Signals	<u>8642A/B,</u> Bands 1-9, HET	<u>8642B,</u> Band 10
Harmonics	-30 dBc -20 dBc	-25 dBc -20 dBc
Sub-harmonics	none	-45 dBc
Non-harmonics	-100 dBc ³	-94 dBc
		Output level ≤ +10 dBm Output level ≤ +16 dBm >10 kHz from the carrier
OUTPUT		
Level Range	From Maximum Level Available to -140 dBm (0.023 μV into 50 ohms)	
Maximum Level Available	+20 dBm (2.24V) +19 dBm (2.00V) +18 dBm (1.78V) +17 dBm (1.59V) +16 dBm (1.41V)	8642A (except Opt. 003) 8642B and 8642A Opt. 003 bands 1 thru 7 bands 1 thru 7 DNA band 8 band 8, HET HET n/a band 9 band 9 band 10 (8642B)
Resolution	0.1 dB	
Absolute Level Accuracy ⁴	±1 dB	
Flatness	< ±0.75 dB	
Impedance	50 ohms nominal	
SWR	<1.5:1 <2.0:1	
Reverse Power Protection	50W, 25 Vdc, 8642A 25W, 50 Vdc, 8642B	
Third Order Intermodulation	< -50 dBc at +10 dBm. Typically decreases 10 dB for every 5 dB of combined level decrease	
Available Calibration Units	dBm, V, mV, μV, dBμV, EMF V, EMF mV, EMF μV, dB EMF μV. REL ZERO or REF SET can be used to obtain settings such as dBV or dBf.	
	Output levels ≥ -127 dBm Output level, +10 dBm Output levels < 0 dBm Output levels ≥ 0 dBm Two signal generators with frequen- cies spaced 25 kHz apart into a resistive combiner	



³Not specified in HET band

⁴Absolute output accuracy consists of allowances for detector linearity, temperature, flatness, and attenuator accuracy.

Table 1-1. Specifications (part of 3 of 6)

Electrical Characteristics	Performance Limits	Conditions
AMPLITUDE MODULATION		
Depth	0% to 99.9%	Output level $\leq +10$ dBm
Resolution	0.1%	
Indicator Accuracy (1 kHz rate, up to 90% AM)	$\pm(3.5\%$ of setting +1% AM)	8642A Bands 1-8, HET; 8642B Bands 1-9, HET
	$\pm(5\%$ of setting +1% AM)	8642A Band 9, 8642B Band 10
AM Distortion at 1 kHz Rate	8642A Bands 1-8, HET; 8642B Bands 1-9 <1% <2% <4%	0% to 30% AM 30% to 70% AM 70% to 90% AM
	8642A Band 9, HET; 8642B Band 10, HET <2% <4% <6%	0% to 30% AM 30% to 70% AM 70% to 90% AM
AM 3 dB Bandwidth (Depth $\leq 90\%$)	dc to 100 kHz 20 Hz to 100 kHz	External dc, bands 1, 5 thru 10 External ac and internal, bands 1, 5 thru 10
	dc to 20 kHz 20 Hz to 20 kHz	External dc, bands ⁵ 2, 3, 4 External ac and internal, bands ⁵ 2, 3, 4
Incidental Φ M (1 kHz rate and 30% AM)	<0.2 radians peak	
⁵ AM bandwidth is increased to 100 kHz in these bands by using Special Function 8 (prefer HET band).		

Table 1-1. Specifications (part of 3 of 6)

Electrical Characteristics	Performance Limits	Conditions
FREQUENCY MODULATION		
Maximum FM Deviation		External dc coupled
Band		
10 (8642B only)	3 MHz	
9	1.5 MHz	
8	750 kHz	
7	375 kHz	
6	187.5 kHz ⁶	
5	93.75 kHz ⁶	
4	46.875 kHz ⁶	
3	23.437 kHz ⁶	
2	11.718 kHz ⁶	
1	93.75 kHz ⁶	
HET	1.5 MHz	
	(the smaller of:)	External ac coupled or internal
10 (8642B only)	3 MHz or $f_{mod} \times 2160$	
9	1.5 MHz or $f_{mod} \times 1080$	
8	750 kHz or $f_{mod} \times 540$	
7	375 kHz or $f_{mod} \times 270$	
6	187.5 kHz or $f_{mod} \times 135^6$	
5	93.75 kHz or $f_{mod} \times 67.5^6$	
4	46.875 kHz or $f_{mod} \times 33.75^6$	
3	23.437 kHz or $f_{mod} \times 16.875^6$	
2	11.718 kHz or $f_{mod} \times 8.4375^6$	
1	93.75 kHz or $f_{mod} \times 67.5^6$	
HET	1.5 MHz or $f_{mod} \times 1080$	
Resolution	0.7% of setting or 0.0004% of maximum deviation, whichever is larger	
Indicator Accuracy	$\pm(5\% \text{ of setting} + 10 \text{ Hz})$	
(Rates 20 Hz to 100 kHz)		
FM Distortion	4%	For maximum dc-coupled deviation
(Rates 20 Hz to 100 kHz)	2%	For 1/2 max dc-coupled deviation
	0.4%	For 1/15 max dc-coupled deviation
FM 3 dB Bandwidth	dc to 200 kHz	External dc source
	20 Hz to 200 kHz	External ac source
	20 Hz to 100 kHz	Internal source

⁶Maximum deviation may be increased up to that shown for the HET band (0.1 MHz to 132.1875 MHz carrier frequency) by selecting deviation larger than the values shown here. HET band can also be selected with Special Function 8.

Table 1-1. Specifications (4 of 6)

Electrical Characteristics	Performance Limits		Conditions
FREQUENCY MODULATION (Cont'd)			
Incidental AM	0.3%		20 kHz peak deviation, 1 kHz rate, >400 kHz carrier frequency, output level $\leq +15$ dBm
Carrier Frequency Offset When Entering FM or PM Modes	none <500 Hz <1 kHz		ac and internal dc, 8642A/B Bands 1-9, HET dc, 8642B Band 10
PHASE MODULATION			
Maximum Phase Deviation			
Band			
10 (8642B only)	200 radians		
9	100 radians		
8	50 radians		
7	25 radians		
6	12.5 radians ⁷		
5	6.25 radians ⁷		
4	3.125 radians ⁷		
3	1.5625 radians ⁷		
2	0.78125 radians ⁷		
1	6.25 radians ⁷		
HET	100 radians		
Resolution	0.7% of setting or 0.0004% of maximum deviation, whichever is larger		
Indicator Accuracy	$\pm(5\%$ of setting $+0.09$ radians)		1 kHz rate
Φ M Distortion	<0.4%		1 kHz rate
Φ M 3 dB Bandwidth	20 Hz to 15 kHz dc to 15 kHz		Internal and external ac External dc
PULSE MODULATION⁸	2509A to 2550A	2551A and above	
Pulse On/Off Ratio	>30 dB >45 dB	>40 dB >80 dB	Output levels $\leq +15$ dBm 8642A/B Bands 1-9, HET 8642B, Band 10
Rise/Fall Time	<3.5 μ s	<400 ns	10% to 90%
Maximum Repetition Frequency	50 kHz	100 kHz	
Minimum Pulse Width	6 μ s	2 μ s	
Nominal Input Threshold Level	1.5V	1.5V	External dc
INTERNAL MODULATION OSCILLATOR			
Frequency Range	20 Hz to 100 kHz		
Frequency Resolution	1% of setting		
Frequency Accuracy	2% of setting		
Output Level Range	0 to 3.3 Vpk		Into 600 ohms
Output Level Resolution	4 mV		
Output Distortion (>0.5 Vpk)	<0.02% <0.15%		0.02 kHz to 15.8 kHz >15.8 kHz
Output Level Accuracy	$\pm(4\% +15$ mV)		Within 1s
Output Impedance	600 ohms $\pm 10\%$		
⁷ Maximum deviation may be increased up to that shown for the HET band (0.1 MHz to 132.1875 MHz carrier frequency) by selecting deviation larger than the values shown here. HET band can also be selected with Special Function 8. ⁸ Output level accuracy is typically ± 3 dB.			

Table 1-1. Specifications (5 of 6)

Electrical Characteristics	Performance Limits	Conditions
GENERAL		
Operating Temperature Range	0° to 55°C	
Storage Temperature Range	-55° to +75°C	
Power Requirements		+5%, -10%
Line Voltage	100V, 120V, 220V, or 240V	
Line Frequency	47.5 to 440 Hz	
Power Dissipation	300 VA max	
Electromagnetic Interference (Leakage)	MIL STD 461B and FTZ 1115	Conducted and radiated interference is within the requirements of MIL STD 461B methods CE03 and RE02. Interference is also within the standards set by FTZ 1115.
		Also RF leakage of <0.5 μV is induced in a two-turn loop 2.5 cm in diameter, held 2.5 cm away from any surface, for output levels ≤0 dBm.
Net Weight	32.7 kg (71.5 lb)	
Shipping Weight	43 kg (95 lb)	
Dimensions		
Height	133 mm (5.25 in.) nominal	
Width	425 mm (16.75 in.) nominal	
Depth	617 mm (23.8 in.) nominal	
HP SYSTEM II		
Module Size	5¼H × 1W × 23D	
Electrical Characteristics	Features	
FREQUENCY SWEEP		
Digitally Stepped Sweep		
Start and Stop Sweep	Sweeps between two selected end-points in a linear, step-wise manner. End-points can be anywhere within the frequency range of the instrument. In AUTO sweep mode, sweep must stay within the range of bands 2 through 9, or band 1, or band 10, or the HET band.	
Time	Maximum sweep time: 999s. Minimum sweep time: 275 ms. A maximum number of distinct frequency points is automatically selected based on the end-points and sweep time.	
Phase Continuous Sweep		
Start-Stop Sweep	Instrument sweeps between two selected end-points in a linear, phase continuous manner.	
Maximum Sweep Span	End-points can be outside the band, but (Start Frequency + Stop Frequency) ÷ 2 must be within the band.	
Band		
10 (8642B only)	800 kHz	
9	400 kHz	
8	200 kHz	
7	100 kHz	
6	50 kHz ⁹	
5	25 kHz ⁹	
4	12.5 kHz ⁹	
3	6.25 kHz ⁹	
2	3.125 kHz ⁹	
1	25 kHz ⁹	
HET	400 kHz	
⁹ Maximum sweep span may be increased up to that shown for the HET band (0.1 MHz to 132.1875 MHz carrier frequency) by selecting a frequency span larger than the span shown here. HET band can also be selected with Special Function 8.		

Table 1-1. Specifications (6 of 6)

Electrical Characteristics	Features
<p>FREQUENCY SWEEP (Cont'd) Phase Continuous Sweep (Cont'd) Sweep Time X-Axis Output Z-Axis Output</p>	<p>Maximum sweep time: 999s. Minimum sweep time: 5 ms. Maximum and minimum sweep time are also dependent on end-point separation and frequency band selected. 0 to 10 Vdc, $\pm 10\%$ TTL positive true for crt display blanking during retrace.</p>
<p>REMOTE OPERATIONS HP-IB (IEEE 488-1978) Capability Interface Functions Controlled HP-IB Address Select Code Interface Function IEEE-488 Functions Implemented</p>	<p>Hewlett-Packard Interface Bus (HP-IB). HP-IB is Hewlett-Packard's implementation of IEEE Standard 488-1978. All functions controlled from the front panel, with the exception of the power switch and the knob, are programmable with the same accuracy and resolution as in manual mode. Settable via the front panel or over HP-IB from 00 to 30 (5-bit decimal equivalent). (A listen-only mode is also available as 31.) Listener, talker, and controller SH1, AH1, T6, TE0, L3, LE0, SR1, RL1, PP0, DC1, DT0, C1, C2, C3, C28, E2</p>

Table 1-2. Supplemental Characteristics (1 of 2)

Supplemental characteristics are typical, but non-warranted performance parameters, intended to be useful in instrument applications.

FREQUENCY

Underrange: 10 to 100 kHz.

Heterodyne Mode (HET, Special Function 8): The 8642A/B can derive its output through a heterodyne mode in the carrier frequency range from 0.1 MHz to 132.1875 MHz. This improves modulation and some frequency sweep characteristics at lower carrier frequencies.

Frequency Switching Time to Within 100 Hz of Final Frequency:

Processor Delay	Frequency Settling	Total Time
20 ms	65 ms	85 ms

SPECTRAL PURITY

SSB Phase Noise at 1 GHz Carrier Frequency (dBc in 1 Hz bandwidth):

10 Hz	100 Hz	1 kHz	10 kHz	20 kHz	100 kHz	200 kHz	1 MHz	10 MHz
-40	-75	-98	-131	-138	-146	-147	-147	-154

Measured SSB Phase Noise at 1 GHz:

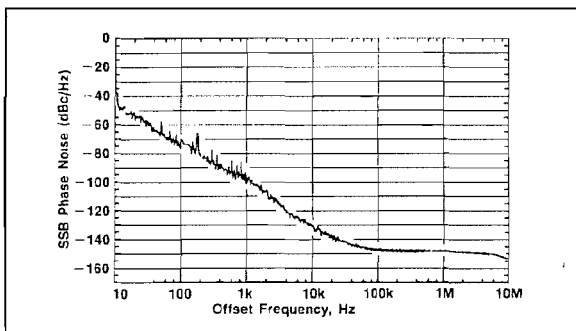

SSB AM Noise Floor at 200 kHz Offset, +16 dBm:

- <-157 dBc/Hz, band 2 through 9.
- <-150 dBc/Hz, band 10.

MODULATION

External Input Impedance: 600 ohms, ±10%.

External Input Level Required: 1 V_{peak} for specified accuracy. Front-panel annunciators indicate application of 1V peak signal ±5%, 20 Hz to 100 kHz. When greater accuracy is required, modulation drive voltage should be monitored externally.

Modulation Source Capability: All modulation types can be driven with either an internal or external modulation source. AM, FM, and ΦM can also be driven simultaneously by both internal and external modulation sources.

Mixed Modulation Types: Any two modulation types can be simultaneously selected except for FM + ΦM and AM + pulse modulation.

FREQUENCY MODULATION

Carrier Stability in FM Mode:

- AC FM: Same as CW.
- DC FM: <4 kHz/hour, 8642A/B bands 1-9, HET.
- <8 kHz/hour, 8642B band 10.

FM Stereo Separation, Ext dc-Coupled, HET Band (Special Function 8): >50 dB, 1 kHz rate, 75 kHz deviation.

Low Distortion FM/ΦM (Special Function 5 or 112): Distortion in either FM or ΦM can be reduced with this function. FM stereo separation unaffected.

FM Distortion in Special Function 7: <0.03% THD, <1/15 maximum deviation, external rates <50 kHz and internal rates <15.8 kHz.

FM Pre-emphasis (Special Function 6): Provides pre-emphasis in FM with a 750 μs time constant. This is useful when testing FM communications receivers.

**AMPLITUDE MODULATION
(for VOR, ILS, Avionics Applications)**

AM Phase Shift, DC Coupled, for Carrier Frequencies From 108 MHz to 118 MHz:

- 30 Hz rate: <±0.01°.
- 30 Hz to 10 kHz rate: <±3°.
- Difference from 9 kHz to 11 kHz rates: <2°.

AM Flatness, DC Coupled External AM:

- <0.04 dB, 90 to 150 Hz, 108 to 118 MHz and 329 to 335 MHz. (<0.00092 DDM @ 20% AM and <0.0019 DDM @ 40% AM.)
- <0.1 dB, 9 to 11 kHz, 108 to 118 MHz.

OUTPUT

Absolute Accuracy: ±3 dB, output level <-127 dBm.

Output Level Switching Time: <100 ms from receipt of last controller command.

Amplitude Sweep, in CW and Angle Modulation Modes:

- Range:** 20 dB log (or linear with Special Function 122) sweep (10 dB underrange available).
- Sweep Time:** 20 ms minimum, 999s maximum.
- Accuracy:** ±1 dB over highest 10 dB. ±3 dB over second highest 10 dB.

Attenuator Range Hold (Special Function 9): The internal step attenuator can be fixed and the electronic level vernier varied up to 30 dB for monotonic level setting. This is useful in measuring of receiver squelch hysteresis.

Table 1-2. Supplemental Characteristics (2 of 2)

Supplemental characteristics are typical, but non-warranted performance parameters, intended to be useful in instrument applications.

INTERNAL REFERENCE OSCILLATOR

Characteristic	Standard	High Stability (opt. 001)
Aging rate	±2 ppm/year	See Table 1-1
Temperature	±4 ppm, 0° to 55°C	±7 × 10 ⁻⁹ , 0° to 55°C
Line voltage	±0.1 ppm, +5%, -10%	±3 × 10 ⁻⁹ , +5%, -10%

EXTERNAL REFERENCE

Input, rear panel:

Frequency: 1, 2, 5, or 10 MHz, ±25 ppm.

Level: >0.5 Vp-p.

Impedance: 500 ohms.

Output, rear panel:

Frequency: 10 MHz.

Level: >1.4 Vp-p into 50 ohms.

Impedance: 75 ohms.

Table 1-3. Recommended Test Equipment (1 of 2)

Instrument	Critical Specification	Recommended Model	Use ¹
Attenuator, Fixed	Attenuation: As required by performance test Frequency Range: 100 kHz-2115 MHz Accuracy: ± 0.1 dB SWR: <1.3	HP 8491A	P
Digital Voltmeter (DVM)	Accuracy: $4\frac{1}{2}$ digit, $\pm 0.05\%$ reading ± 1 digit Range: 10 mV to 600V Sensitivity: 10 μ V	HP 3456A	A, T
Frequency Standard	Frequency: 10 MHz Long Term Stability: $<1 \times 10^{-10}/24$ hours	HP 5065A	P, A
Low-Noise Amplifier	Input/Output Impedance: 50 ohms Frequency Bandwidth: 1 kHz to 1 MHz Noise Figure: <3 dB Gain: 40 ± 1 dB	HP 08640-60506 Requires 19-25 Vdc Power Supply	P
Low-Pass Filter	Bandwidth: 1 MHz Impedance: 50 ohms	See Figure 1-1	P
Measuring Receiver	Modulation: Accuracy: $\pm 2\%$ of reading AM Rejection: <30 Hz at 50% AM (3 kHz BW) FM Rejection: <0.2% AM (50 kHz FM) Power: Frequency Range: 0.1 to 2115 MHz Power Range: +20 to -20 dBm Accuracy: ± 0.2 dB Tuned Power: Frequency Range: 2.5 MHz to 1300 MHz Power Range: 0 dBm to -127 dBm Accuracy: ± 0.5 dB Frequency: Resolution: 10 Hz Audio Distortion (Typical Residual): <-60 dB	HP 8902A Opt. 002 (Opt. 003 for Optional Residual FM Test)	P, A
Mixer	Frequency: 0.2 to 500 MHz Type: Double Balanced	HP 10514A	P
Mixer	Frequency: 500 to 2115 MHz Type: Double Balanced	Watkins-Johnson M94C	P
Oscilloscope	Vertical Sensitivity: 10 mV/division Bandwidth: 100 MHz	HP 1980B/HP 19860A (see Table 1-4)	P, A, T
Service Accessory Kit	Required for servicing and troubleshooting. See Table 1-5 for parts listing and description.	HP 11801A/B/C ²	A, T
Signal Generator	Frequency: .1 to 2115 MHz Output: -50 dBm to +18 dBm SSB Phase Noise: same or better than the specification for the Generator under test.	HP 8642B (see Table 1-4)	P, A, T
Spectrum Analyzer	Frequency Range: 100 Hz to 6345 MHz Resolution Bandwidth: ≤ 10 Hz Dynamic Range: 90 dB	HP 8566A/B	P, A, T

¹P = Performance Testing, A = Adjustments, T = Troubleshooting²HP 11801A services the HP 8642A, HP 11801B services the HP 8642B, and HP 11801C services both.

Table 1-3. Recommended Test Equipment (2 of 2)

Instrument	Critical Specification	Recommended Model	Use ¹
SWR Bridge	Directivity: >40 dB	Wiltron 60NF50	P
Function Generator	Max. Rate: >50 kHz Min. Pulse Width: <6 μsec Rise Time: ≤100 nsec	HP 8116A	P
Signal Generator (optional)	Residual SSB phase noise in 1 Hz BW (320 MHz ≤ f _c < 640 MHz) with an offset from the carrier of: -100 dBc at 10 Hz, -121 dBc at 1 kHz, and -131 dBc at 10 kHz	HP 8662A (for Optional Residual FM Test)	P
Short, Type N		HP 11512A	P
Feedthrough Termination, BNC	z ₀ = 600 ohms ±1%	HP 11095A (see Table 1-4)	P

¹P = Performance Testing, A = Adjustments, T = Troubleshooting

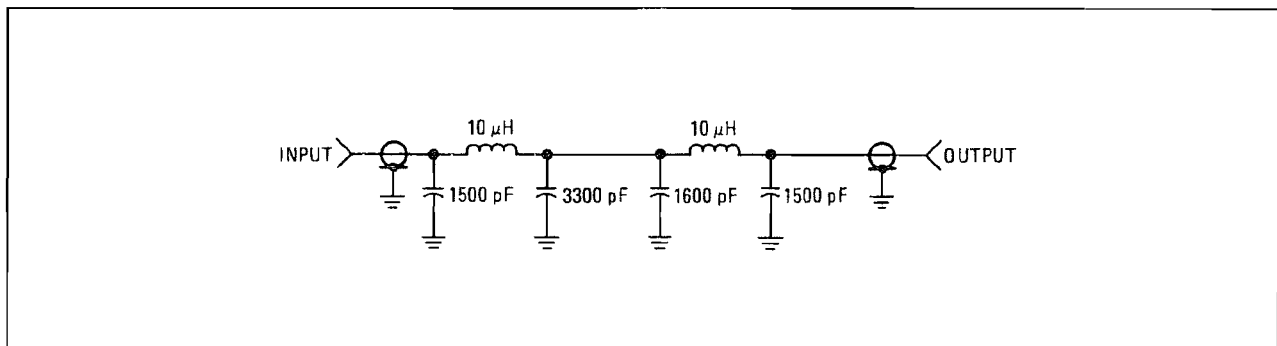

Figure 1-1. 1 MHz Low-Pass Filter

Table 1-4. Alternative Test Equipment

Instrument	Recommended Model	Suggested Alternative	Advantage of Alternative
Digital Voltmeter (DVM)	HP 3456A	HP 3455A	Satisfies the requirements for testing the Signal Generators.
Signal Generator	HP 8642B	HP 8340A HP 8341A HP 8663A HP 8662A	Satisfies the requirements for testing the Signal Generator except: 1. Third Order Intermodulation Test requires +18 dBm at 1050 MHz. 2. Optional Phase Noise Test requires phase noise less than or equal to the unit under test. 3. The 8662A satisfies the RF frequency range for 8642A testing.
Oscilloscope	HP 1980B/HP 19860A	HP 1740A	Satisfies the requirement for testing the Signal Generator.
Feedthrough Termination, BNC	HP 11095A	HP 0757-1100	Satisfies the requirement for testing the Signal Generator.

Table 1-5. HP 11801C On-Site Service Kit (1 of 2)

HP Part Number	Check Digit	Quantity	Description	Reference Designation
08642-60889	7	1	Keyboard/LCD Display Module	A1
08642-69889	5	1	Keyboard/LCD Display Module (Restored)	
08642-60890	0	1	Modulation Module	A2
08642-69890	8	1	Modulation Module (Restored)	
08642-60891	1	1	Processor/Memory Module	A3
08642-69891	9	1	Processor/Memory Module (Restored)	
08642-60892	2	1	Latch Module	A4
08642-69892	0	1	Latch Module (Restored)	
08642-60893	3	1	FM Loop/Counter/Timebase Module	A6
08642-69893	1	1	FM Loop/Counter/Timebase Module (Restored)	
08642-60894	4	1	SAWR Loop Module	A7
08642-69894	2	1	SAWR Loop Module (Restored)	
08642-60895	5	1	IF Loop Module	A9
08642-69895	3	1	IF Loop Module (Restored)	
08642-60896	6	1	Reference Loop Module	A11
08642-69896	4	1	Reference Loop Module (Restored)	
08642-60897	7	1	Sum Loop/Divider Module	A12
08642-69897	5	1	Sum Loop/Divider Module (Restored)	
08642-60898	8	1	Output Filters/ALC Module	A13
08642-69898	6	1	Output Filters/ALC Module (Restored)	
08642-60899	9	1	Heterodyne Module	A14
08642-69899	7	1	Heterodyne Module (Restored)	
08642-60842	2	1	Attenuator Module—8642A Only	A16
08642-69842	0	1	Attenuator Module (Restored) 8642A Only	
08642-60843	3	1	Power Supply Regulators/Attenuator Drivers Module	A17
08642-69843	1	1	Power Supply Regulators/Attenuator Drivers Module (Restored)	
08642-60844	4	1	Power Supply Rectifier/Filter Module	A18
08642-69844	2	1	Power Supply Rectifier/Filter Module (Restored)	
2110-0010	9	5	Fuse 5A 250V NTD 1.25 × .25 UL	A18F1
2110-0002	9	10	Fuse 2A 250V NTD 1.25 × .25 UL	A18F2/F4
2110-0036	9	5	Fuse 8A 125V NTD 1.25 × .25 UL	A18F3
2110-0004	1	5	Fuse .25A 250V NTD 1.25 × .25 UL	A18F5
08642-60845	5	1	Doubler/Attenuator Module—8642B Only	A19
08642-69845	3	1	Doubler/Attenuator Module (Restored) 8642B Only	
08642-60133	4	8	Calibration Module	A20
08642-69133	2	8	Calibration Module (Restored)	
08642-80019	7	1	Fan Assembly	B1
2110-0003	0	5	Fuse 3A 250V NTD 1.25 × .25 UL	F1
5021-0844	1	2	Adapter, BNC to Banana Plug	
1250-0832	8	2	Adapter, Coax STR Female BNC to Female SMC	
1250-1697	5	2	Adapter, Coax STR Male SMA to Female SMC	
1250-0827	1	4	Adapter, Coax STR Male SMC to Male SMC	
8710-0033	2	1	Alignment Tool, Screwdriver .075	
9222-0779	1	15	Bag, Anti-static 16 × 0 inch Opening	
9222-0698	3	8	Bag, Anti-static 4 × 0 inch Opening	
8710-1465	8	1	Bit, Torx T10	
8710-1493	2	1	Bit, Torx T15	
8710-1541	1	1	Bit, Torx T5	
08662-60080	4	4	Cable Assembly, Short	
08662-60075	7	1	Cable Assembly, Service Kit, Long	
1400-0249	0	10	Cable Tie, .062-.625 Dia. .091 Wd Nylon	

Table 1-5. HP 11801C On-Site Service Kit (2 of 2)

HP Part Number	Check Digit	Quantity	Description	Reference Designation
11801-90201	0	1	Case, Large	
11801-90203	2	1	Case, Small	
1251-8601	7	1	Connector, Ribbon Cable, 34 Pin	
1251-8248	8	1	Connector, Ribbon Cable, 26 Pin	
1251-8105	6	1	Connector, Ribbon Cable, 16 Pin	
1251-8823	5	1	Connector, Ribbon Cable, 14 Pin	
08642-20041	9	2	Extender Post	
11801-90202	1	1	Foam, Top and Bottom (for large case)	
11801-90204	3	1	Foam, Top and Bottom (for small case)	
08642-40073	9	1	Fuse Puller	
9300-0980	2	1	Grounding Strap, Anti-Static	
2140-0536	7	5	Lamp, Incand. 5 Vdc, 115 mA, T-1 Bulb	
08642-90020	1	1	On-Site Service Manual	
---		1	Storage Box, Plastic, 1 Compartment	
---		1	Storage Box, Plastic, 10 Compartments	
9320-3944	6	5	Tag, Blue Stripe	
11801-90001	8	10	Tag, Defective	
34118A	0	1	Test Lead Kit	
08642-00070	2	1	Wrench, RF Connector	
8730-0012	1	1	Wrench, Torque	
9300-0985	7	1	Wristband, Antistatic	
1250-0781	6	1	BNC Tee (f, m, m)	
1250-0837	3	1	SMC Tee (m, m, m)	
08642-80053	9	1	Power Supply Test Connector	
1251-5653	3	1	Connector, Ribbon Cable, 50 Pin	

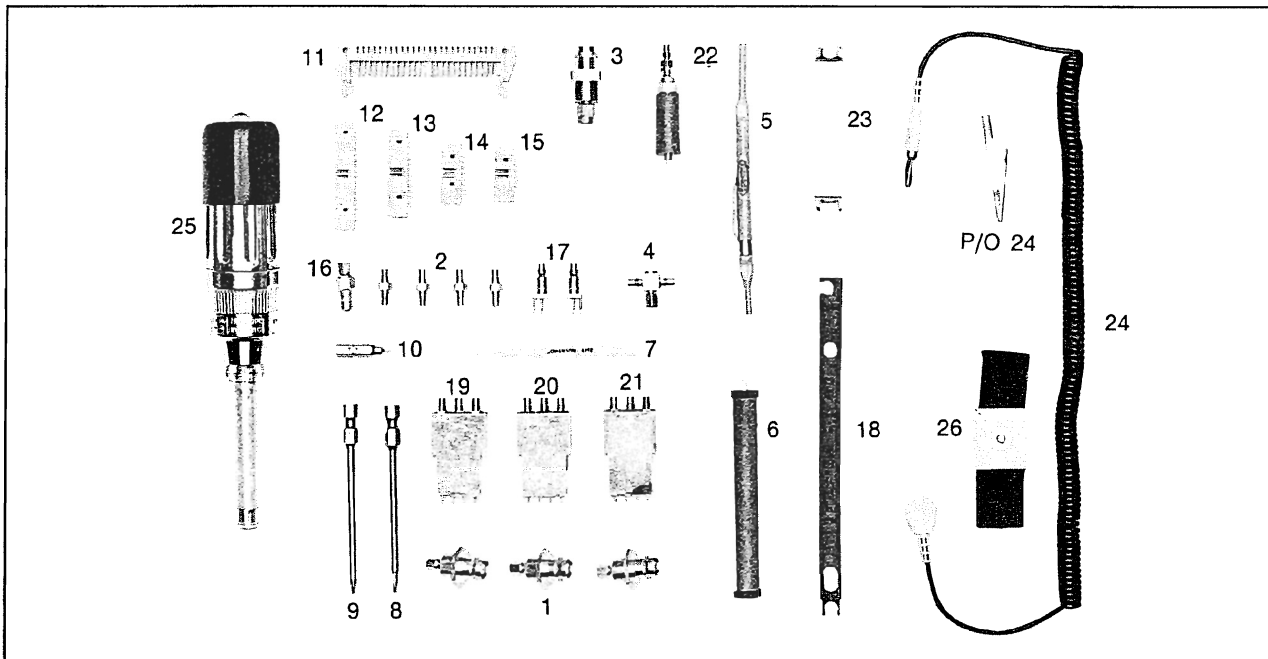

Item Number	Part Number	Check Digit	Quantity	Part Description
1	1250-0832	8	3	Adapter, Coax STR Female BNC to Female SMC
2	1250-0827	1	4	Adapter, Coax STR Male SMC to Male SMC
3	1250-1200	6	1	Adapter, SMA to BNC
4	1250-0838	4	1	Adapter, Tee, Female, Male, Male SMC
5	8710-0630	7	1	Alignment Tool, Screwdriver .08
6	8710-0033	4	1	Alignment Tool, Screwdriver .075
7	8710-1515	9	1	Alignment Tool, Square, .030
8	8710-1465	8	1	Bit, Torx T10
9	8710-1493	2	1	Bit, Torx T15
10	8710-1541	1	1	Bit, Torx T5
Not Shown	08642-60135	6	1	Board Assembly, Latch Extender
Not Shown	08642-60137	8	1	Board Assembly, Processor Extender
Not Shown	08642-60134	5	1	Board Assembly, Signature Analysis
Not Shown	08662-60080	4	4	Cable Assembly, Short
Not Shown	08662-60075	7	1	Cable Assembly, Service Kit, Long
Not Shown	11802-90202	2	1	Case, 20.8 x 14.8
Not Shown	11802-90201	1	1	Foam, Top and Bottom
11	1251-5653	3	1	Connector, Ribbon Cable, 50 Pin
12	1251-8601	7	1	Connector, Ribbon Cable, 34 Pin
13	1251-8248	8	1	Connector, Ribbon Cable, 26 Pin
Not Shown	1251-8812	2	1	Connector, Ribbon Cable, 20 Pin
14	1251-8105	6	1	Connector, Ribbon Cable, 16 Pin
15	1251-8823	5	1	Connector, Ribbon Cable, 14 Pin
Not Shown	1252-0153	0	1	Connector, Ribbon Cable, 10 Pin
16	1250-0839	5	1	Terminal, Female SMC
17	1250-1598	5	2	Connector, Male SMC, RF
18	08642-40073	9	1	Fuse Puller
19	08642-60951	4	1	Probe, 4 Pin Mixer
20	08642-60078	6	1	Probe, 8 Pin Mixer
21	08642-60079	7	1	Probe, 8-Pin Power Splitter
22	08642-20089	5	1	Reference/Sum Loop
23	08642-00070	1	1	RF Connector Wrench
24	9300-0980	2	1	Strap, Anti-static Grounding
25	8730-0012	1	1	Wrench, Torque .2-.4 Newton-meters
26	9300-0985	7	1	Wristband, Anti-static

Figure 1-2. Bench Service Kit

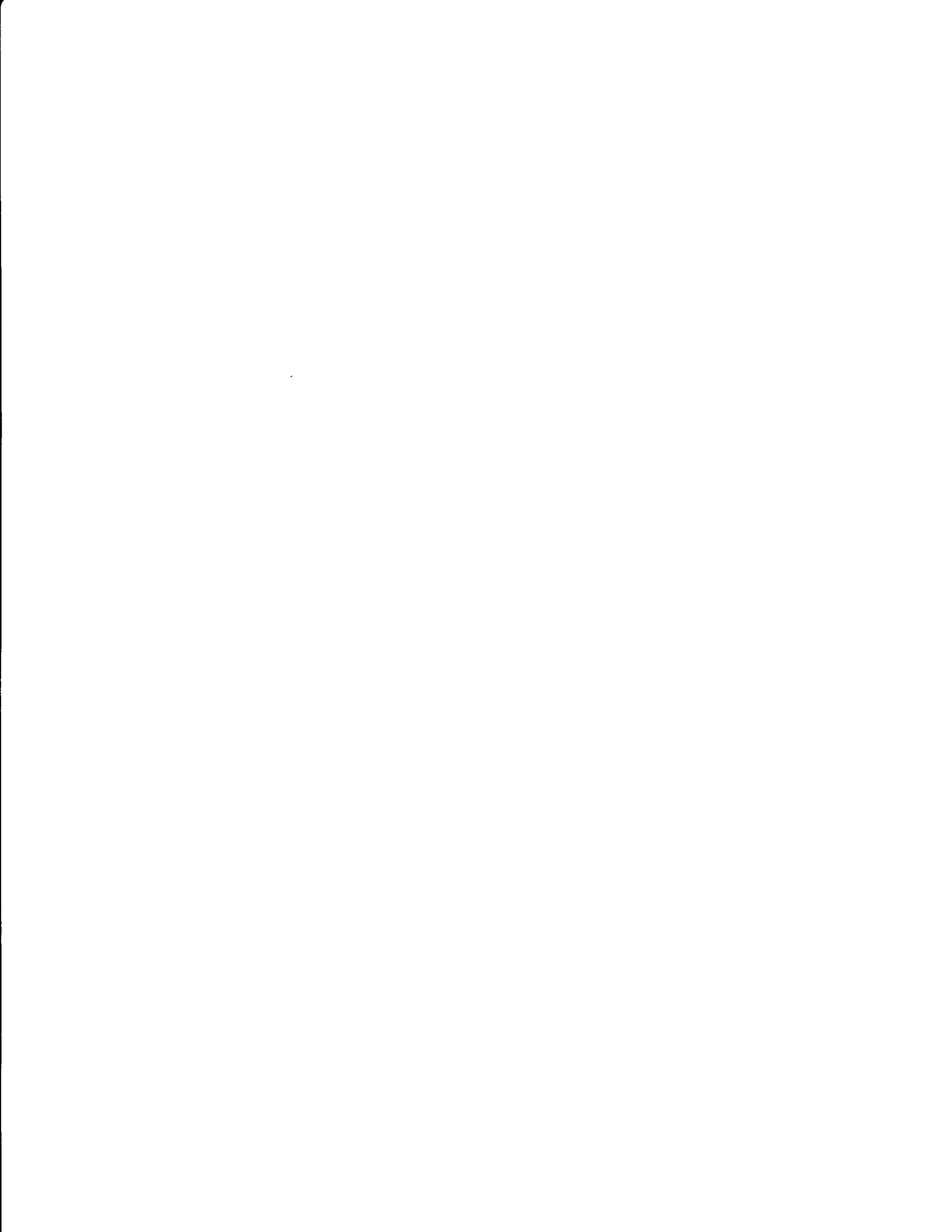

SECTION II

INSTALLATION

2-1. INTRODUCTION

This section provides the information needed to install the HP 8642A/B Synthesized Signal Generator. Included is information pertinent to initial inspection, power requirements, line voltage selection, power cables, interconnection, environment, instrument mounting, storage, and shipment.

2-2. INITIAL INSPECTION

WARNING

To avoid hazardous electrical shock, do not perform electrical tests when there are signs of shipping damage to any portion of the outer enclosure (covers and panels).

Inspect the shipping container for damage. If the shipping container or cushioning material is damaged, it should be kept until the contents of the shipment have been checked for completeness and the instrument has been checked mechanically and electrically. Procedures for checking electrical performance are given in Section IV, Performance Tests. If the contents are incomplete, if there is mechanical damage or defect, or if the instrument does not pass the electrical performance test, notify the nearest Hewlett-Packard office. If the shipping container is damaged, or the cushioning material shows signs of stress, notify the carrier as well as the Hewlett-Packard office. Keep the shipping materials for the carrier's inspection.

2-3. PREPARATION FOR USE

Power Requirements

The Signal Generator requires a power source of 100 Vac (90 to 105 Vac), 120 Vac (108 to 126 Vac), 220 Vac (198 to 231 Vac), or 240 Vac (216 to 252 Vac), 47.5 to 440 Hz single phase. Power consumption is 260 VA maximum (270 VA during attenuator switching).

WARNING

This is a Safety Class I product (i.e., provided with a protective earth terminal). An uninterruptible safety earth ground must be provided from the Mains power source to the product input wiring terminals, power cord, or supplied power cord set. Whenever it is likely that the protection has been impaired, the instrument must be made inoperative and be secured against any unintended operation.

If this instrument is to be energized via an external autotransformer for voltage reduction, make sure that the common terminal is connected to the earthed pole of the power source.

CAUTION

BEFORE PLUGGING THIS INSTRUMENT into the Mains (line) voltage, be sure the correct voltage and fuse have been selected.

A rear-panel, line power module permits operation from 100, 120, 220, or 240 Vac. The number visible in the window (located on the module) indicates the nominal line voltage to which the instrument must be connected. Verify that the line voltage selection card and the fuse are matched to the power source. Refer to Figure 2-1, Line Voltage and Fuse Selection.

Two fuses are supplied with each instrument. One fuse has the proper rating for 110/120 Vac line operation (HP part number 2110-0003; 3A, 250V, non-time-delay). The other fuse is rated for 200/220 Vac operation (HP part number 2110-0002; 2A, 250V, non-time-delay).

One fuse is installed in the instrument at the time of shipment. The rating of the installed fuse is selected according to the line voltage specified by the customer. If the voltage is not specified, the rating of the installed fuse will be selected according to the country of destination.

WARNING

For protection against fire hazard, the line fuse should only be a 250V normal blow fuse with the correct current rating.

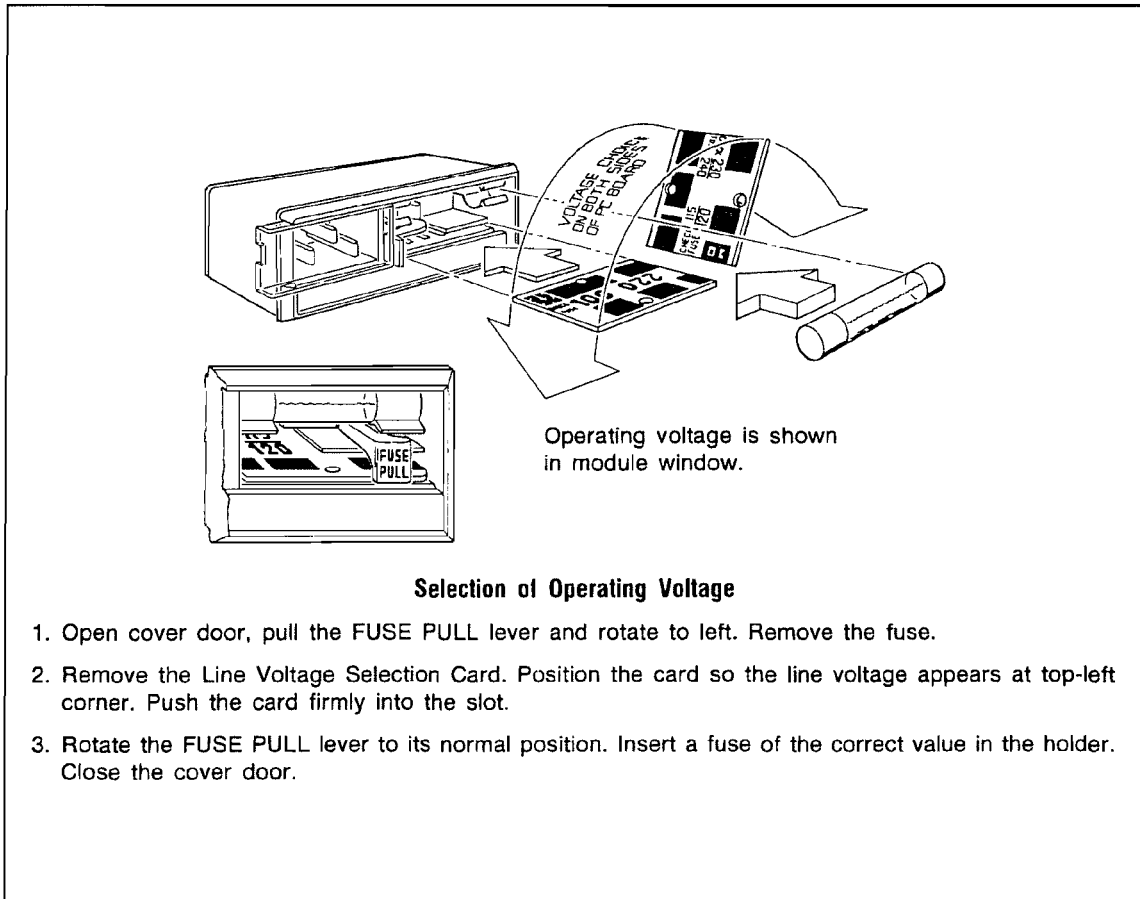

Figure 2-1. Line Voltage and Fuse Selection





Power Cables

WARNING

BEFORE CONNECTING THIS INSTRUMENT, the protective earth terminal of the instrument must be connected to the protective conductor of the (mains) power cord. The mains plug shall only be inserted in a socket outlet provided with a protective earth contact. The protective action must not be negated by the use of an extension cord (power cable) without a protective conductor (grounding). Grounding one conductor of a two conductor outlet is not sufficient protection.

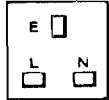
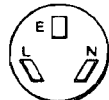
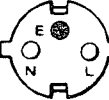
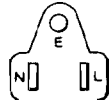
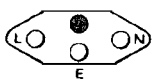
This instrument is equipped with a three-wire power cable. When connected to an appropriate ac power receptacle, this cable grounds the instrument cabinet. The type of power cable plug shipped with each instrument depends on the country of destination. Refer to Table 2-1 on page 2-4 for the part numbers of the power cables and Mains plugs available.

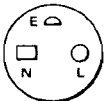
Table 2-1. AC Power Cables Available (P/O ERRATA)

Plug Type	Cable HP Part Number	C D	Plug Description	Cable Length (inches)	Cable Color	For Use In Country
250V 	8120-1351 8120-1703	0 4	90°/STR BS1363A* 90°/90°	90 90	Mint Gray Mint Gray	United Kingdom, Cyprus, Nigeria, Rhodesia, Singapore
250V 	8120-1369 8120-0696	0 4	STR/STR NZSS198/ASC112* STR/90°	79 80	Gray Gray	Australia, New Zealand
250V 	8120-1689 8120-1692	7 2	STR/STR* STR/90°	79 79	Mint Gray Mint Gray	East and West Europe, Saudi Arabia, Egypt, (unpolarized in many nations)
125V 	8120-1378 8120-1521 8120-1751	1 6 1	STR/STR NEMA5-15P* STR/90° STR/STR	80 80 90	Jade Gray Jade Gray Jade Gray	United States, Canada, Mexico, Phillipines, Taiwan U.S./Canada
100V (Same plug as above)	8120-4753 8120-4754	2 3	STR/STR STR/90°	90 90	Dark Gray Dark Gray	Japan only Japan only
250V 	8120-2104 8120-2296 8120-3997	3 4 4	STR/STR SEV1011 1959-24507 Type 12 STR/90° STR/90°	79 79 177	Gray Gray Gray	Switzerland
250V 	8120-0698	6	STR/STR NEMA6-15P	90	Black	United States, Canada
250V 	8120-2956 8120-2957 8120-3997	3 4 4	90°/STR 90°/90° STR/STR	79	Gray	Denmark
250V 	8120-4211 8120-4600	7 8	STR/STR*IEC83-B1 STR/90°	79 79	Black Gray	South Africa, India
250V 	8120-1860 8120-1575 8120-2191 8120-4379	6 0 8 8	STR/STR*CEE22-V1 (Systems Cabinet Use) STR/STR STR/90° 90°/90°	59 31 59 80	Jade Gray Jade Gray Jade Gray Jade Gray	

* Part number shown for plug is industry identifier for plug only. Number shown for cable is HP Part Number for complete cable including plug. E = Earth Ground; L = Line; N = Neutral; STR = Straight

HP-IB Address Selection 

The Signal Generator's address is set to 19 at the factory both in RAM memory and an internal switch located inside the instrument. The address stored in RAM remains valid through switching the power from standby to on and unplugging of the ac power cord (unless the internal battery power is lost which would cause RAM memory to be lost). If RAM memory is ever lost, the address on the internal switch is read and becomes the address at turn on. Refer to page 3-8 for procedures to set the Signal Generator's HP-IB address.

Interconnections 

Interconnection data for the Hewlett-Packard Interface Bus is provided in Figure 2-2, Hewlett-Packard Interface Bus Connections.

Mating Connectors

Interface Connector. The HP-IB mating connector is shown in Figure 2-2. Note that the two securing screws are metric.

Coaxial Connectors. Coaxial mating connectors used with the Signal Generator should be either the 50-ohm BNC male connectors or 50-ohm Type-N male connectors that are compatible with those specified in US MIL-C-39012.

Operating Environment

The operating environment should be within the following limitations:

Temperature	0°C to +55°C
Humidity	5 to 95% (maximum wet bulb temperature = 40°C)
Altitude	<4570 meters (15 000 feet)
Airflow	5.8 mm (0.23 in.) minimum clearance underneath the instrument and sufficient clearance at the instrument's right side for air flow that is not obstructed.

Rack Mounting**WARNING**

The Signal Generator is heavy for its size (32.7 kg, 71.5 lb). Care must be exercised when lifting to avoid personal injury.

CAUTION

When rack mounting, it is important that proper support rails are used to support the Signal Generator. Additional support rail sets for HP cabinets can be ordered under HP part number 12679B.

Rack mounting information is provided with the rack mounting kit. If the kit was not ordered with the instrument as an option, it may be ordered through the nearest Hewlett-Packard office. For rack-mount kit part numbers, refer to page 1-4, paragraph 1-9, Options Available with the Instrument, under Mechanical Options.

The Rack-Slide Kit enables service personnel to slide the Signal Generator away from the cabinet and service it at the operating site. Therefore, if you plan to take advantage of the On-Site Service Strategy for the HP 8642A/B, we recommend that you use the Rack-Slide Kit to rack mount the instrument. For instrument cabinet frames using metric hardware, the HP part number is 08642-80059. For instrument cabinet frames using English hardware, the HP part number is 08642-80058. (Note that if metric hardware is used, the rear panel of the instrument mentions that fact.)

2-4. STORAGE AND SHIPMENT

Environment

The instrument should be stored in a clean, dry environment. The following environmental limitations apply to both storage and shipment:

Temperature	-55°C to +75°C
Humidity	5% to 95% (maximum wet-bulb temperature = 40°C)
Altitude	15 300 meters (50 000 feet)

Packaging

Original Packaging. Containers and materials identical to those used in factory packaging are available through Hewlett-Packard offices. If the instrument is being returned to Hewlett-Packard for servicing, attach a tag indicating the type of service required, return address, model number, and full serial number. Also mark the container FRAGILE to assure careful handling. In any correspondence refer to the instrument by model number and full serial number.

Other Packaging. The following general instructions should be used for repackaging with commercially available materials:

1. Wrap the instrument in heavy paper or plastic. (If shipping to a Hewlett-Packard office or service center, attach a tag indicating the service required, return address, model number, and full serial number.)
2. Use a strong shipping container. A double wall carton made of 2.4 MPa (350 psi) test material is adequate.
3. Use enough shock-absorbing material (75 to 100 mm layer; 3 to 4 in.) around all sides of the instrument to provide firm cushion and prevent movement in the container. Protect the front panel with cardboard.
4. Seal the shipping container securely.
5. Mark the shipping container FRAGILE to ensure careful handling.

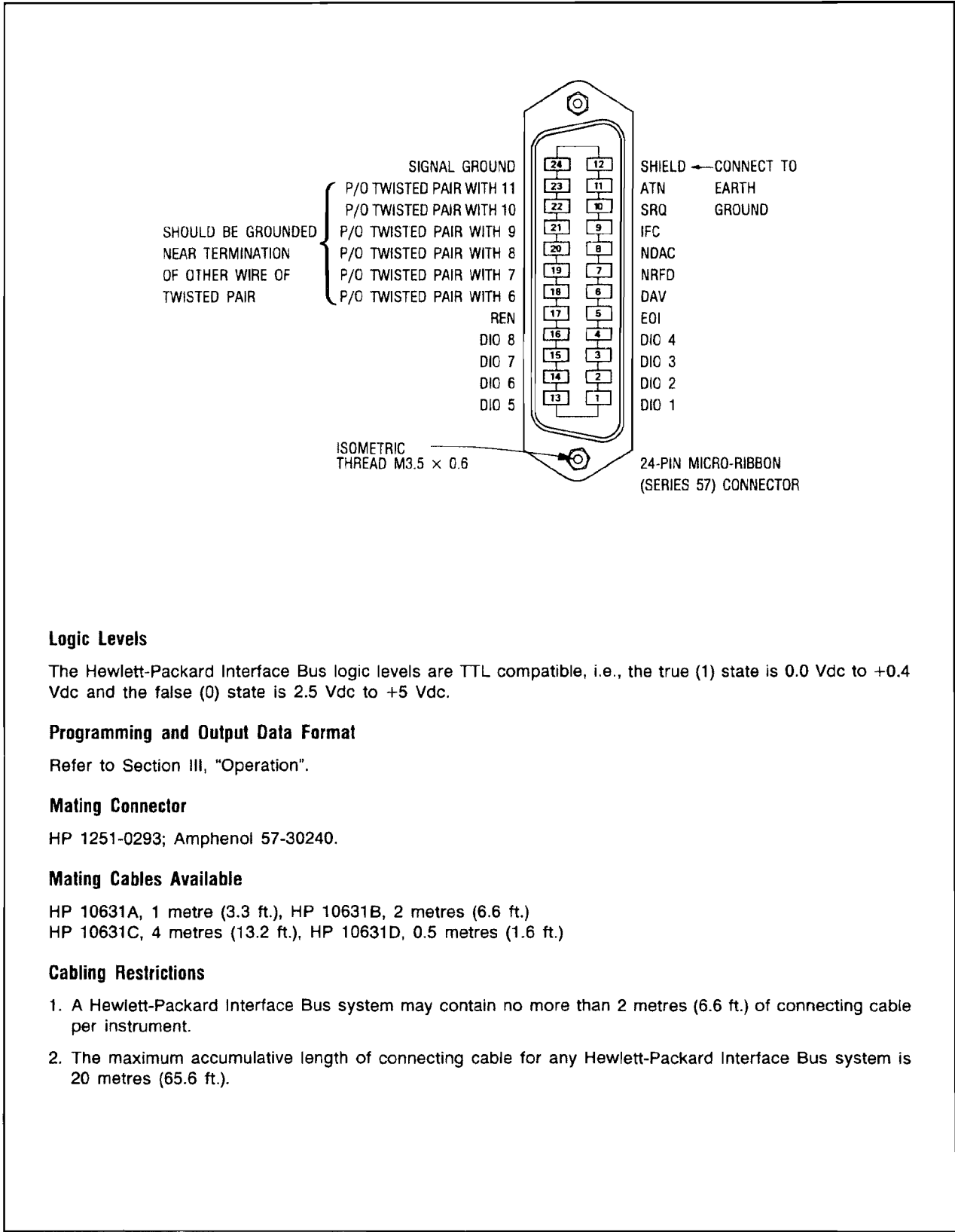

Logic Levels

The Hewlett-Packard Interface Bus logic levels are TTL compatible, i.e., the true (1) state is 0.0 Vdc to +0.4 Vdc and the false (0) state is 2.5 Vdc to +5 Vdc.

Programming and Output Data Format

Refer to Section III, "Operation".

Mating Connector

HP 1251-0293; Amphenol 57-30240.

Mating Cables Available

HP 10631A, 1 metre (3.3 ft.), HP 10631B, 2 metres (6.6 ft.)
 HP 10631C, 4 metres (13.2 ft.), HP 10631D, 0.5 metres (1.6 ft.)

Cabling Restrictions

1. A Hewlett-Packard Interface Bus system may contain no more than 2 metres (6.6 ft.) of connecting cable per instrument.
2. The maximum accumulative length of connecting cable for any Hewlett-Packard Interface Bus system is 20 metres (65.6 ft.).

Figure 2-2. Hewlett-Packard Interface Bus Connections



SECTION III OPERATION

INTRODUCTION TO SECTION III

The information in this section describes both general and specific operation of the HP 8642A/B. If you have no experience with the Signal Generator, you should first read Operating Fundamentals (included with this Volume I as a separate booklet) which is intended only as a familiarization guide. Although this Section III can be used to learn basic operation, you might feel there is more information here than you need. After you read Operating Fundamentals you can use this Operation Section for additional information.

Figure 3-1 in Operating Information (page 3-3) is a graphic representation of the Signal Generator's basic operation. This figure shows most of the keys that you use to operate the instrument. Similar diagrams that show more specific functions (and their associated keys) are available on pages 3-34, 3-38, 3-68, 3-96, 3-136, 3-156, 3-166, and 3-178. Figure 3-2 on page 3-4 shows rear-panel features.

The major functions of this section are grouped as follows:

- Operating Information
- HP-IB Remote Operation
- Detailed Operating Instructions
 - RF Frequency
 - Amplitude
 - Modulation
 - Setting Modifications
 - Recall Registers
 - Special Functions
 - Messages
- Appendixes
- Index

OPERATOR CHECKS

Since the Signal Generator performs self-checks, no operator checks are necessary. However, extensive self-diagnostics are available. Refer to the Service Section (Volumes 2 through 4).

FUSE REPLACEMENT

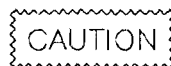

The casual operator should not replace the LINE fuse. Replacing this fuse in a damaged Signal Generator might cause additional damage. A qualified service person should first determine the cause of the failure (specifically with resistance checks in the power supply), repair the failure, and then replace the fuse.

DETAILED OPERATING INSTRUCTIONS

The Detailed Operating Instructions are organized into major categories that are described on the previous page under the "Introduction to Section III". Each operating instruction begins on a right facing page for easy accessibility. This means that sometimes you will see a blank page before the beginning of an operating instruction. Each of the Detailed Operating Instructions provides specific, function-related information. We have arranged each of these instructions in the following format:

Description

The information given under "Description" provides an overall description of the function(s) to be discussed in that particular operating instruction. The Signal Generator's front-panel functions are divided into three types: Key Functions, Shift Key Functions, and Special Functions.

Key Functions. Key functions are labeled directly on the key that accesses the function. You can access a key function by pressing the key directly. In these instructions, we show the key function's label in capital letters surrounded by what resembles a key shape (for example, **FREQ** or **AMPTD**).

Shift Key Functions. Shift key functions are labeled in blue above the key that accesses the function (for example, **REF SET** or **REL ZERO**). You can access a shift key function by first pressing the blue **SHIFT** key (which causes the display to show "SHIFT") and then the key under the blue label. In these instructions, we show the shift key function's blue label in capital letters (for example, **REF SET**) followed by the actual key you need to press to access that function. That is, we would show:
REF SET (**SHIFT** **FREQ**).

Special Functions. You can turn on a special function by pressing SPCL (**SHIFT** **-**), then by keying in the code number of the desired special function. (After you select a special function, its code and description are displayed. You can clear this message from the display by pressing the **SHIFT** key twice.)

Procedures

The "Procedures" provide examples to show you how to operate the function (or functions) explained in the "Description". Before each example, we instruct you to select Instrument Preset to put the Signal Generator in a known state so that your instrument will display identical settings as in the display portion of our examples.

HP-IB Codes

All HP-IB codes relevant to that operating instruction are listed.

Comments

The "Comments" add extra information about the function(s) that might be valuable.

Related Special Functions

The "Related Special Functions" list and describe some special functions that might apply to the main function.

Related Operating Instructions

This listing refers you anywhere else in the Detailed Operating Instructions that will provide related information about the topic or topics you are reading about.

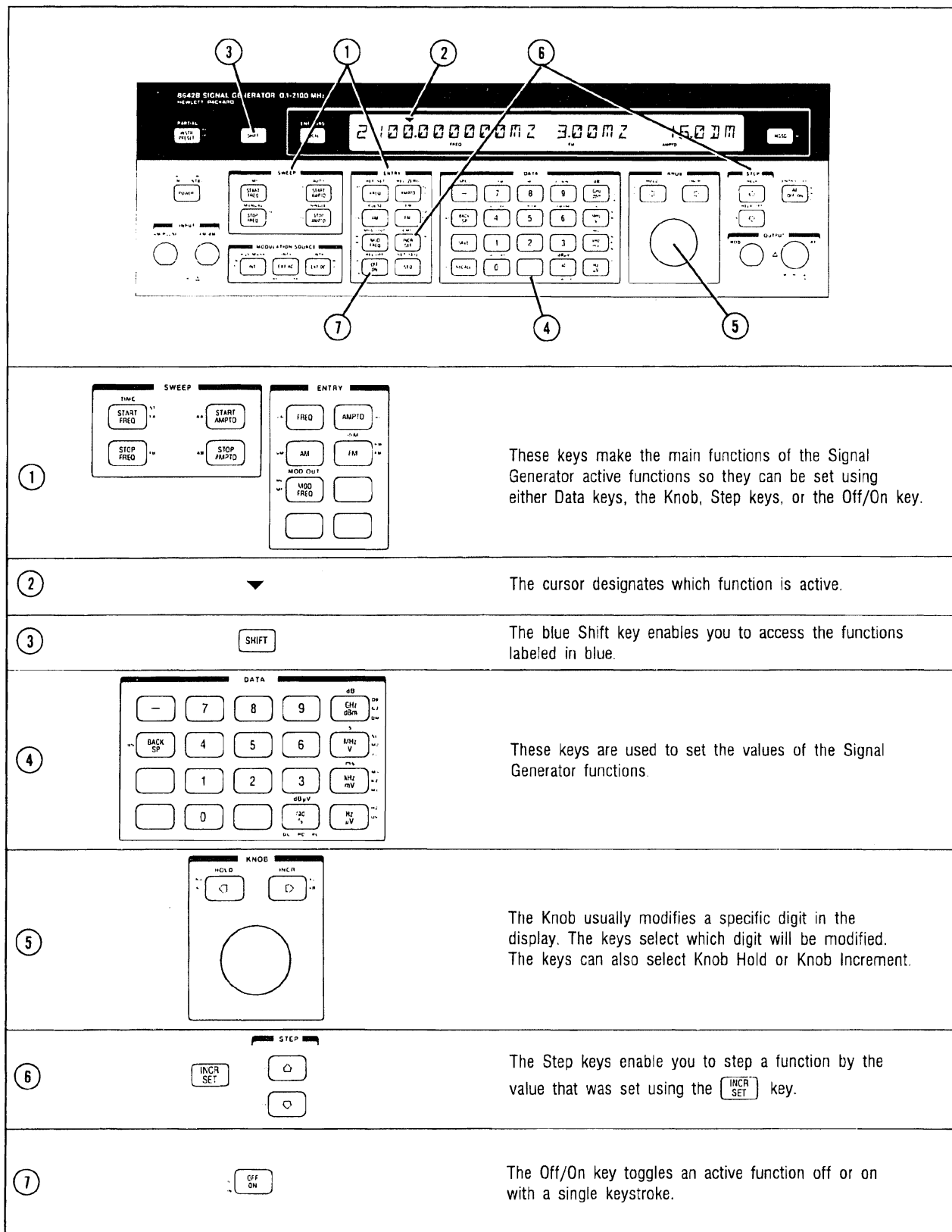

Figure 3-1. An Overview of the Basic Functions of the 8642A/B

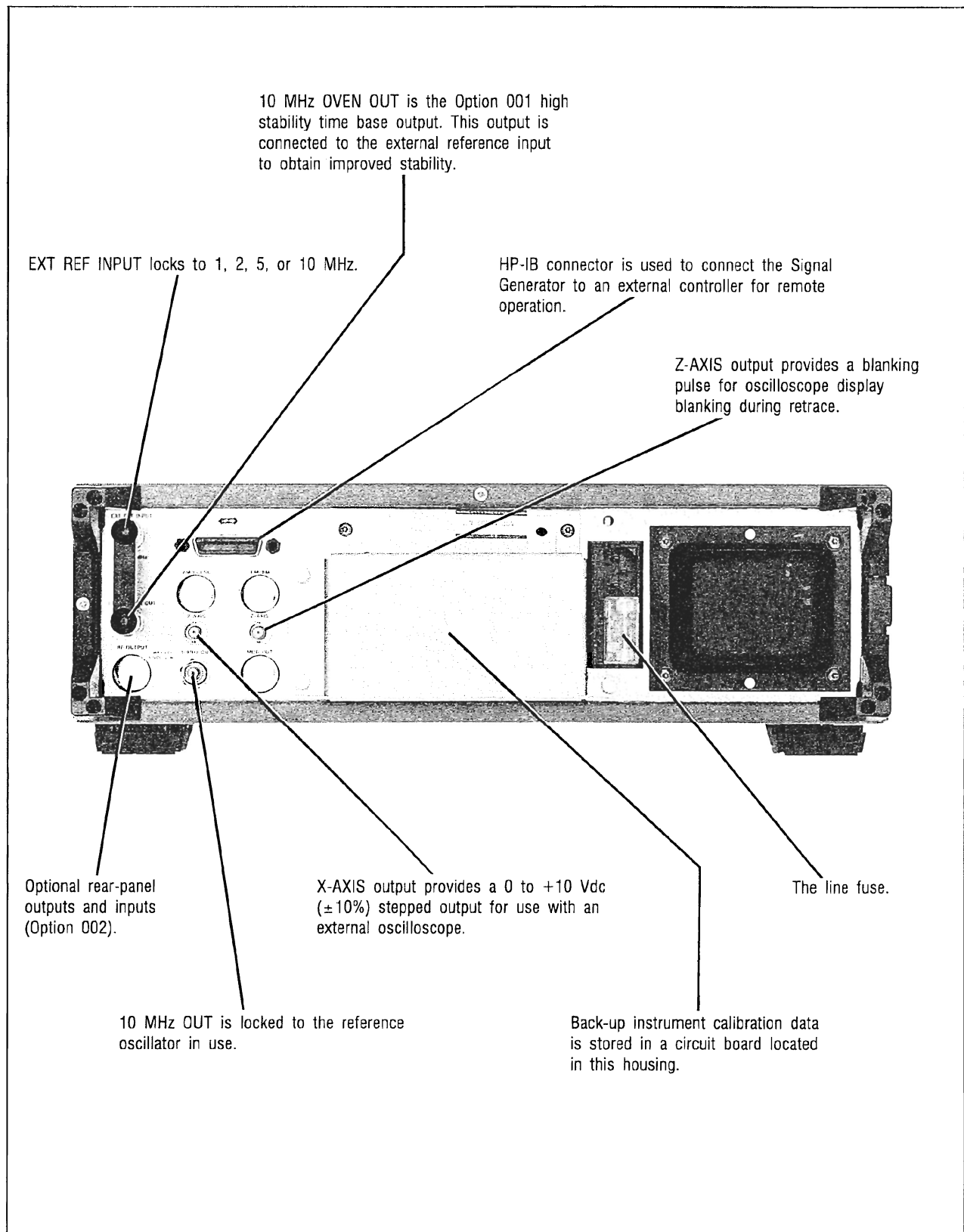

Figure 3-2. Rear-Panel Features



HP-IB CONTENTS

HP-IB REMOTE OPERATION	3-7	LOCAL	3-25
HP-IB ADDRESS	3-8	Remote to Local Transition	3-25
Available Addresses	3-8	LOCAL LOCKOUT, SET LOCAL	3-26
To Display the Current Address	3-8	Local Lockout	3-26
ENT ADRS	3-8	Clear Lockout/Set Local	3-26
To Change the Address	3-8	SERVICE REQUEST	3-27
HP-IB CAPABILITIES	3-9	Overview	3-27
Overview	3-9	RQS MASK	3-27
HP-IB Capabilities	3-9	Clearing the Service	
Table 3-1. HP-IB Capability		Request Message	3-27
ReferenceTable	3-10	Figure 3-4. The Status Byte and	
DATA INPUT	3-11	RQS Mask	3-28
Overview	3-11	STATUS BYTE	3-29
Table 3-2. Data Input Example	3-11	Overview	3-29
Program Codes	3-11	Reading the Status Byte	3-29
Input Syntax	3-11	Clearing the Status Byte	3-29
Table 3-3. Relationship Between		Table 3-7. HP-IB Status Byte	
Keystrokes and HP-IB Code		Bit Definitions	3-30
Sequences	3-12	ADDITIONAL HP-IB INFORMATION	3-31
Sequence Dependency	3-12	Abort	3-31
Figure 3-3. Flowcharts for		Trigger	3-31
Sequence Dependency	3-13	Status Bit	3-31
Valid Character Entry	3-14	Controller Capabilities; Self Test	
DATA OUTPUT	3-15	and Calibration	3-31
Overview	3-15	Display Control Via HP-IB	3-31
Output Messages (OH, OE, OC)	3-16	Remote Indicators	3-31
Output Active Function (OA)	3-18	Disabling the Listen	
Table 3-4. Output Active Function		Addressed State	3-31
String Formats	3-19	Disabling the Talk Addressed State	3-31
Output HI, LO Status (OL)	3-20	HP-IB CODES SUMMARY	3-32
Output Display Information	3-21	Table 3-8. Signal Generator Function	
Table 3-5. Output Display; Binary		to HP-IB Code	3-32
Weight of Annunciators	3-22	Table 3-9. Signal Generator HP-IB	
Table 3-6. Error Code and Message		Code to Function	3-33
Recovery Example Program	3-23	HP-IB RELATED FRONT-PANEL KEYS	3-34
CLEAR	3-24	Figure 3-5. HP-IB Related	
Overview	3-24	Front-Panel Keys	3-34
REMOTE, LOCAL	3-25	HP-IB RELATED TERMS	3-35
Local to Remote Transition	3-25		



HP-IB REMOTE OPERATION

The 8642A/B is fully programmable via the Hewlett-Packard Interface Bus (HP-IB) which can be operated with any Hewlett-Packard computing controller or computer for automatic system applications. For more information about **HP-IB**, refer to one or all of the following documents:

- IEEE Standard 488-1978,
- ANSI Standard MC1.1,
- "Improving Measurements in Engineering and Manufacturing" (HP part number 5952-0058) (the Hewlett-Packard catalog of Electronic Systems and Instruments), or
- "Tutorial Description of the Hewlett-Packard Interface Bus" (HP part number 5952-0156).

All front-panel functions are programmable over **HP-IB** except Knob rotation and switching the Power from Standby to On.



HP-IB ADDRESS

The Signal Generator's address is set to 19 at the factory both in RAM memory and on an internal switch located inside the instrument. You can change the address in RAM from the front panel.

The address stored in RAM remains valid through switching the Power from Standby to On and unplugging of the ac power cord. However, if the internal battery power is lost, RAM memory is lost and the Signal Generator reads the address on the internal switch. The internal switch address then becomes the address at turn on. At any time, the instrument's HP-IB address can be displayed from the front panel.

Available Addresses

Any address from 00 to 30 can be assigned to the instrument.

Setting an address of 31 establishes the Signal Generator as a listen-only device. The listen-only mode causes the instrument to allow either HP-IB or local operation. However, any keys pressed while the Signal Generator is receiving HP-IB information could suspend the instrument in an unknown state. Also, with this address setting, the HP-IB control lines should be left open-circuited: IFC, ATN, REN, SRQ, and EOI (Refer to Figure 2-2 on page 2-7 for HP-IB connector pin numbers for these lines.)

To Display the Current Address

From the front panel, select ENT ADRS (SHIFT LOCAL).

ENT ADRS To Change the Address

From the front panel, select ENT ADRS (SHIFT LOCAL), followed by a data entry from 00 to 31, and HZ UV (or any terminator)

The Signal Generator's internal switch address can also be changed using a procedure described in Section VIII of the Service Manual in Service Sheet 2. However, this address will only be used when Power is turned from Standby to On if the internal battery power is lost.

WARNING

The setting of the switch that is described in Section VIII is intended for service-trained persons who are aware of the potential shock hazard of working on an instrument with protective covers removed.

Comments

System Control

Setting the address from the front panel when the instrument is in its service mode will disable any activated HP-IB control capabilities. (Refer to the Service Manual for more information about configuring the Signal Generator as a system controller to perform various self-test and self-calibration routines.)



HP-IB CAPABILITIES

Overview

The 8642A/B Signal Generator is designed to be compatible with a controller that interfaces in terms of the 12 bus messages summarized in the HP-IB Capability Reference Table on page 3-10. The bus functions are discussed in more detail in the following text. The Signal Generator's complete capability (as defined by IEEE Standard 488 and the identical ANSI Standard MCL1.1) is described at the bottom of Table 3-1 and on page 1-2 under "HP-IB Capabilities".

HP-IB

Capabilities

In remote mode, all front-panel controls are disabled except the Power switch and the Local key (the Local key can be disabled by configuring the instrument in Local Lockout). The Signal Generator will respond to each HP-IB message below according to its associated listen or talk address. (Each of these capabilities is described in more detail on the pages that follow.)

Input Data. When addressed to listen (with REN true), the Signal Generator stops talking and can respond to input data. (Refer to page 3-11.)

Output Data. When addressed to talk, the Signal Generator stops listening and can send output data. (Refer to page 3-15.)

Clear (Selected Device Clear, SDC) When addressed to listen (with REN true), the Signal Generator stops talking and responds to SDC by clearing any uncompleted entries or messages. (Refer to page 3-24.)

Clear (Device Clear, DCL) Regardless of the addressed state of the Signal Generator (whether addressed to listen or to talk), it stops talking and responds to DCL by clearing any uncompleted entries or messages. (Refer to page 3-24.)

Local When addressed to listen (with REN true), the Signal Generator stops talking and responds to the Local command by returning from remote control to local control. (Refer to page 3-25.)

Local Lockout. Regardless of the addressed state of the Signal Generator (whether addressed to listen or to talk), it responds to the Local Lockout command by disabling the front-panel Local key. (Refer to page 3-26.)

Clear Lockout and Set Local. Regardless of the addressed state of the Signal Generator (whether addressed to listen or to talk), it responds to the Clear Lockout and Set Local command by re-enabling the front-panel Local key and returning from remote control to local control. (Refer to page 3-26.)

Require Service. Regardless of the addressed state of the Signal Generator (whether addressed to listen or to talk), it can send the Require Service message. (Refer to Service Request, page 3-27.)

Status Byte. When addressed to talk, after receiving the Serial Poll Enable (SPE) bus command, the Signal Generator outputs the Status Byte. (Refer to page 3-29.)

Abort. Regardless of the addressed state of the Signal Generator (whether addressed to listen or to talk), it responds to the Abort command and stops listening or talking. (Refer to page 3-31.)

HP-IB Capabilities from Local Mode

Besides having the above capabilities while remote, the following capabilities are also available from the local mode:

- Require Service
- Status Byte
- Data (Output)



HP-IB Capabilities (cont'd)

Table 3-1. HP-IB Capability Reference Table

HP-IB Capability	Applicable	Response	Related Commands and Controls*	Interface Functions*
Data	Yes	All front-panel functions, special functions, and remote-only functions are programmable (except Knob Rotation). The Signal Generator can send status byte, message, and setting information. The front-panel LSTN and TLK annunciators turn on as appropriate when the instrument is addressed.	MLA MTA EOI	T6 L3 AH1 SH1
Trigger	No	The Signal Generator does not have a device trigger capability.	GET	DT0
Clear	Yes	The Signal Generator responds equally to DCL and SDC bus commands. The Clear capability does not reset instrument parameters.	DCL SDC	DC1
Remote	Yes	The Signal Generator's remote mode is enabled when the REN bus line is true. However, it remains in local (i.e., the keyboard is active) until it is first addressed to listen. The output signal is unchanged when the Signal Generator enters the remote mode. The front-panel RMT annunciator turns on when in remote mode.	REN MLA	RL1
Local	Yes	The Signal Generator returns to front-panel control when it enters the local mode. The output signal is unchanged. Responds either to the GTL bus command or the front-panel LOCAL key. The LOCAL key will not work if the instrument is in the Local Lockout State.	GTL	RL1
Local Lockout	Yes	Local Key is disabled during Local Lockout so only the controller or the POWER switch can return the Signal Generator to local.	LLO	RL1
Clear Lockout/ Set Local	Yes	Generator returns to local and Local Lockout is no longer true when the REN bus lines goes false.	REN	RL1
Pass Control/ Take Control	No	The Signal Generator cannot pass or take control of HP-IB. However it does have limited control capability that is intended for servicing the instrument. This control capability is accessed with Service Special Functions.	ATN IFC	C1 C2 C3 C28
Require Service	Yes	The Signal Generator sets the SRQ bus line true if one of the following conditions exists and it has been enabled by the RQS mask to send the message for that condition: Parameter Changed, Error, Ready, Local/Remote, Execution Error, Hardware Error, or End of Sweep.	SRQ	SR1
Status Byte	Yes	The Signal Generator responds to a Serial Poll Enable (SPE) bus command by sending an 8-bit byte when addressed to talk. Bit 6 (RQS bit) is true if Signal Generator had sent the Require Service Message. Each bit requires different conditions for clearing.	SPE SPD MTA	T6
Status Bit	No	The Signal Generator does not respond to a parallel poll.	ATN EOI	PP0
Abort	Yes	The Signal Generator stops talking or listening.	IFC	T6, L3

*Commands, Control lines and Interface Functions are defined in IEEE Std 488 (and the identical ANSI Standard MC1.1). Knowledge of these might not be necessary if your controller's manual describes programming in terms of the twelve HP-IB Messages shown in the left column.

Complete HP-IB capability as defined in IEEE Std 488 (and the identical ANSI Standard MC1.1) is:
SH1, AH1, T6, TE0, L3, LE0, SR1, RL1, PP0, DC1, DT0, C1, C2, C3, C28, E2.



DATA INPUT

Overview Data can be input to the Signal Generator using either front-panel keystrokes or via HP-IB.

To address the Signal Generator via HP-IB, the input data information usually contains the universal unlisten command, the Signal Generator's listen address, the controller's talk address, and a string of HP-IB program codes.

The following Table 3-2, shows some possible Signal Generator settings and corresponding HP BASIC commands.

Table 3-2. Data Input Example

Input Data	HP BASIC
Set frequency to 123.4 MHz	OUTPUT 719; "FR 123.4 MZ"
Set amplitude to -10 dBm	OUTPUT 719; "AP -10 DM"
Set amplitude increment to 10 dB, decrement amplitude 20 dB	OUTPUT 719; "APIS 10 DB APDN APDN"
Examples assume: Signal Generator's address = 19	

Refer to your controller manual for command syntax and the controller's address.

Program Codes

The Signal Generator's functions can be accessed with specific program codes. These program codes are summarized in **HP-IB Codes Summary** in Table 3-8, Signal Generator Function to HP-IB Code (page 3-32), and Table 3-9, Signal Generator HP-IB Code to Function (page 3-33). In addition, most HP-IB codes are printed on the instrument's front panel, in light gray print, near the code's associated key.

Input Syntax

Input data information consists of one or more bytes sent over the bus' eight data lines when the bus' attention control line [ATN] is false, and when the Signal Generator is remote and addressed to listen with the REN line true (low). The Signal Generator processes ASCII characters individually as they are received and performs the function specified as soon as a recognizable sequence of characters has been received.

Accessing the Signal Generator's front-panel key functions via HP-IB is equivalent to accessing them from the front-panel. Table 3-3, on the following page, compares some local keystroke sequences and their corresponding HP-IB code sequences. (Direct access to the shift functions is possible from HP-IB so the Shift key is not used in HP-IB coding.)



Data Input (cont'd)

Table 3-3. Relationship Between Keystrokes and HP-IB Code Sequences

Function	Front-Panel Keystroke Sequence	HP-IB Sequence
To set a 1 MHz RF output frequency	FREQ 1 MHz V	FR 1 MZ
To set an RF frequency reference of 1 MHz	FREQ REF SET (SHIFT FREQ) 1 MHz V	FRRS 1 MZ
To select Special Function 111	SPCL (SHIFT -) 1 1 1	SP 111

Sequence Dependency

Some functions in the 8642A/B are coupled together because of internal circuit configuration limitations. This coupling can limit the execution of a setting when one function limits the setting of the other.

For example, amplitude and AM depth are coupled functions; An AM depth of 99.0% is possible only when the amplitude setting is between -140.0 and +14.0 dBm. Therefore,

changing this setting:

Amplitude = +14 dBm,
AM depth = 99%

to this setting:

Amplitude = +15 dBm
AM depth = 75%

would not be possible if the amplitude entry was attempted before the AM setting. AM could be changed first to achieve the setting, but setting AM first would not always be successful. For example, if you were changing back to the first example (to an amplitude of +14 dBm and AM depth of 99%), setting the AM first would not set the requested AM setting. (To eliminate this sequence dependency problem when setting AM or amplitude, first turn off AM, then set the amplitude, then set the AM depth.)

How to Avoid Sequence Dependency Problems

The Detailed Operating Instructions in this Operating Manual describe the limitations of specific coupled functions and will help you avoid entering incorrect sequences. Also, when operating locally, displayed Execution Error messages direct you to your entry error. However, if operating via HP-IB, it might be inconvenient to rely either on the manual or on error messages for every combination of settings. Flowcharts of Sequence Dependency, on the following page, can assist in the development of driver subprograms to eliminate the consequences of sequence dependency. If you follow the flowcharts and still cannot obtain the requested setting, that setting is probably not possible.



When setting one or more of the following, use the appropriate flowchart:

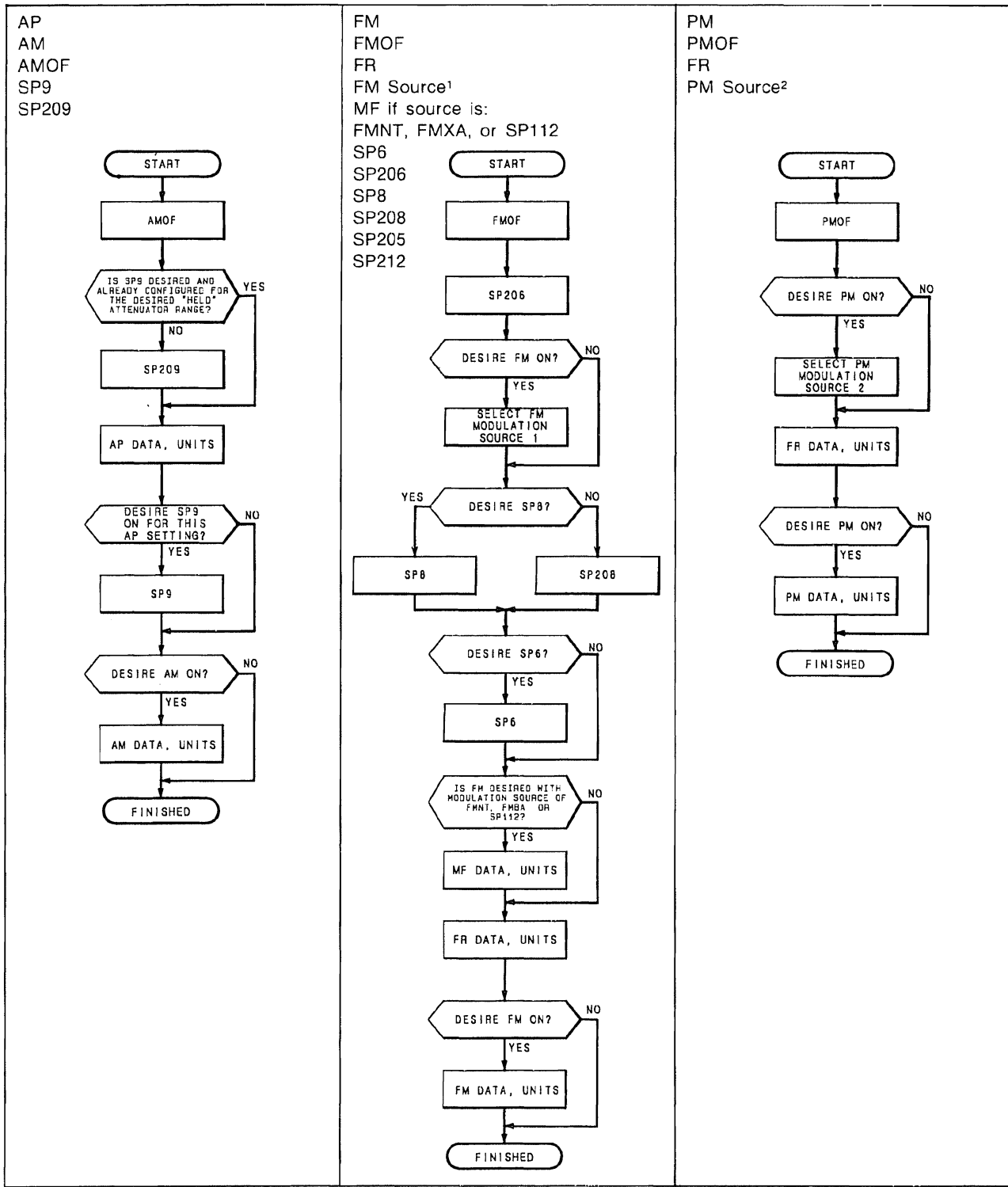

¹FM Modulation Sources include: FMNT, FMXA, FMXD, FMBA, FMBD, SP5, SP112.

²PM Modulation Sources include: PMNT, PMXA, PMXD, PMBA, PMBD.

Figure 3-3. Flowcharts for Sequence Dependency



Data Input (cont'd)

Exceptions to Flowcharts

Not covered in those flowcharts is frequency sweep's dependence on entry sequence. Frequency sweeps are coupled to FM and Φ M settings. When selecting either Digitally Stepped Frequency Sweep or Phase Continuous Frequency Sweep with either FM or Φ M, use the following sequence:

1. Turn off frequency sweep (FAOF FBOF).
2. Select either Special Function 123 (Phase Continuous Frequency Sweep) or Special Function 223 (Phase Continuous Frequency Sweep Off which enables the selection of Digitally Stepped Frequency Sweep).
3. If FM is to be selected, use the FM flow chart (but don't set FM yet, nor FR).
4. If Φ M is to be selected, use the Φ M flow chart (but don't set PM yet, nor FR).
5. With Start Frequency (FA) or Stop Frequency (FB) active, select the sweep mode (FASA for auto, FASM for manual, or FASG for single).
6. Select the sweep time setting.
7. Select either the start or stop frequency setting. (Choose the frequency setting that is in the band that allows the desired FM or Φ M setting.)
8. Select the desired FM or Φ M deviation setting.
9. Select either the stop or start frequency setting (whichever of these which was not set in step 7.)

Valid Character Entry

When entering data over HP-IB, the data entry can take the form of:

Implicit point notation (for example, 100 MZ), or
 Fixed point notation (for example, 100.0 MZ), or
 Exponential notation (for example, 1000E-1 MZ).

Each function has an HP-IB data-entry limit of 10 mantissa digits and 2 exponential digits (exponential notation is optional). For example, the following entries for 100 MHz will be accepted:

1000000000E-01 HZ
 1000000000E-1 HZ
 1000000000E-4 KZ

However, these entries for 100 MHz will not be accepted:

1000000000E-02 HZ (this entry will be accepted as 10 MHz)
 100000000E-006 MZ (this entry won't be accepted and could cause problems in subsequent data entries)

Only the following data inputs are recognized over HP-IB by the Signal Generator; all other characters are ignored:

A-Z, a-z (lower-case letters are converted to upper case)
 0-9
 . + -

Leading zeroes are treated as significant digits

The space character, carriage return, and line feed are ignored.



DATA OUTPUT

Overview The Signal Generator can send the following data messages when it is addressed to talk:

Status Byte (refer to **Status Byte** on page 3-29)

Messages (discussed below)

Display Information (discussed below)

Service Messages (refer to Section VIII of the Service Manual for specific Service Message information)

The Signal Generator can output the following messages and display information (normally viewed on the front-panel display) using **HP-IB** codes that do not have equivalent front-panel keys. The **HP-IB** codes are in parenthesis after each message listed below:

Output Messages

Hardware Errors (OH)

Execution Errors (OE)

Parameters Changed Messages (OC)

Output Active Function (OA)

Output HI, JO Status (OL)

Output Display (Output Display is the default **HP-IB** output when nothing else is configured for data output; it does not require an **HP-IB** code to output data.)



Data Output (cont'd)

Output Messages

Hardware Errors (OH)

These messages signal the presence of either an internal circuit hardware problem or a firmware problem. (Refer to **Messages**, page 3-177, for more information about these messages; each message code is prefixed with the letter "H" in the listing in that section.)

The presence of one or more of these messages is signaled when bit 1 of the Status Byte is set. (Refer to **Status Byte** on page 3-29.) Some service-related messages can also cause this bit to be set. (Refer to the Service Manual.)

Execution Errors (OE)

These messages describe the Signal Generator's reason for not executing an attempted setting. (Refer to **Messages**, page 3-177, for more information about these messages; each message code is prefixed with the letter "E" in that listing.)

The presence of one of these messages is signaled when bit 2 of the Status Byte is set. (Refer to **Status Byte** on page 3-29.) Some service-related messages can also cause this bit to be set. (Refer to the Service Manual.)

Parameters Changed Messages (OC)

These messages inform you that the Signal Generator has changed some other setting to allow a new setting. Some of the Signal Generator's functions cannot occur simultaneously with other functions, so the Signal Generator will automatically adjust or turn off the functions that are preventing the new setting. For example, AM is turned off when pulse modulation is selected; the Output Parameters Changed Message is "AM TURNED OFF .C11". (Refer to **Messages**, page 3-177, for more information about these messages; each message code is prefixed with the letter "C" in that listing.)

The presence of this message is signaled when bit 7 of the Status Byte is set. (Refer to **Status Byte** on page 3-29.) Some service-related messages can also cause this bit to be set. (Refer to the Service Manual.)

Examples

The Signal Generator can output either the message code number or the message string (the alphanumeric display) for any of the above messages. Table 3-6, Error Code and Message Recovery Example Program (on page 3-23), provides some sample subprograms that detail a way to retrieve the Signal Generator's messages.

Execution Errors and Parameters Changed Messages

After it receives "OE" or "OC" and is addressed to talk the first time, the Signal Generator will output the message code number. The second time it is addressed to talk, the Signal Generator will output the message string.

You can read only the first Execution Error message if more than one of these has occurred since either the Status Byte was cleared or since the last time "OE" was executed. Then reading a message using "OE" will enable you to read out only the first Execution Error message.



You can read only the first Parameters Changed message if more than one of each of these has occurred since either the Status Byte was cleared or since the last time "OC" was executed. Then reading a message using "OC" will enable you to read out only the first Parameters Changed message.

Following is a programming example in BASIC for outputting an Execution Error (OE):
Output either an Execution Error code number or message string from the Signal Generator (address 19) and reset bit 2 of the Status Byte:

To output the message code number:

```
10 OUTPUT 719; "OE"
20 ENTER 719; A
```

To output the message string:

```
10 OUTPUT 719; "OE"
20 ENTER 719; A           ! Dummy read of the message code number
30 ENTER 719; A$
```

The above examples can also be modified to apply to an Output Parameters Changed (OC) message if you send "OC" instead of "OE". Sending either "OE" or "OC" alone (program line 10 above) will reset the appropriate status bit (unless RQS is true, in which case the Status Byte must be read again to clear the status bit)

Note that you should not execute an instrument function between setting up the instrument for data output and reading the data from the Signal Generator. To illustrate this consideration, refer to the "OE" example above. If you were to insert a line 15 that set an instrument function such as AM, the data received from the Signal Generator will be the display data, not the Execution Error message code, because "AM" would have superseded the "OE" data output preparation.

Hardware Errors

Hardware Error messages are handled differently than Execution Error or Parameters Changed messages since more than one message can be present. These messages are stored as a queued up list with a maximum number of 22 messages. (Read about queued up messages on page 3-180). To properly retrieve all the queued up messages, follow the "OH" command with a software loop as shown in the sample program in Table 3-6 (page 3-23).



Data Output (cont'd)

Output Active Function (OA)

Output Active Function enables the Signal Generator to output the setting of a selected active function over HP-IB. The Signal Generator outputs a string that can be directly read into a numeric variable or into a string variable which includes the HP-IB codes for both the function and its units specifier (maximum of 19 characters).

Following is a programming example in BASIC for outputting the active function (OA):
Output the RF frequency setting as either a numeric value or a string from the Signal Generator (address 19). ("OA" should be preceded by the function's HP-IB code.)

To output the numeric value:

```
10 OUTPUT 719; "FROA"
20 ENTER 719; V           ! Value is output in Hz
```

To output the alphanumeric character string:

```
10 OUTPUT 719; "FROA"
20 ENTER 719; A$
```

The functions and values that can be output over HP-IB using "OA" are listed below along with some format parameters.

Meanings of Values That Could Be Output

- 200 indicates the function is off.
- 201 indicates RF.OFF. (for amplitude only).
- 202 indicates reverse power is tripped (for amplitude only).

A space character is placed before and after the numeric portion of the string.

Output String Formats

Table 3-4, Output Active Function String Formats (on the following page), lists the output format for each active function string.

The meanings of symbols in Table 3-4 are as follows.

- s = sign character, either "+" or "-"
- d = digit (Leading zero digits greater than the one's digit are suppressed.)

Comments

If a function's value is in relative units, the displayed, relative setting (not the absolute setting) will be output. You can output absolute units by converting from relative units to absolute units before outputting the active function. Refer to page 3-205 for amplitude units conversion information.

"OA" can be sent without a function prefix. The first two characters in the output string will designate the active function. If the Signal Generator does not have an active function when it receives "OA" without a function prefix, it will output the display string (which is the default HP-IB output).



Table 3-4. Output Active Function String Formats

Function	String Format
Frequency (Value could be negative if Frequency is relative)	FR sddddddddd.0 HZ
Amplitude (in dBm) (in dB relative, dB EMF relative, dB μ V, or dB EMF μ V) (in volts or EMF volts)	AP sddd.d DM AP sddd.d DB AP +d.ddddddddd VL
AM	AM +dd.d PC
FM	FM +ddddddd.0 HZ
Φ M	PM +ddd.dddddd RD
Modulation Frequency	MF +dddddd.d HZ
Modulation Output Level	ML +d.dddd VL
Start Frequency	FA +ddddddddd.0 HZ
Stop Frequency	FB +ddddddddd.0 HZ
Start Amplitude (in dBm) (in volts or EMF volts)	AA sddd.d DM AA +d.ddddddddd VL
Stop Amplitude (in dBm) (in volts or EMF volts)	AB sddd.d DM AB +d.ddddddddd VL
Sweep Time	ST +ddd.ddd SC
Leading zero digits greater than the one's digit are suppressed.	



Data Output (cont'd)

Output HI, LO Status (OL)

Output HI, LO status enables an HP-IB Controller to monitor the level of the external modulation signal by configuring the Signal Generator to output the status of the HI, LO annunciators for AM, FM, or Φ M. The status can be read as either a numeric value or as a string that represents the HI and LO annunciators.

Annunciator	Numeric Value Representation	String Representation
HI	+1	HI
LO	-1	LO
neither HI nor LO	0	OK

Following is a programming example in BASIC for outputting HI, LO status (OL):
Output from the Signal Generator (address 19) the status of its HI, LO annunciators for an external, ac-coupled AM signal.

To output the numeric value:
10 OUTPUT 719; "AMOL"
20 ENTER 719; V

To output the string:
10 OUTPUT 719; "AMOL"
20 ENTER 719; V
30 ENTER 719; AS

! Dummy read of the numeric value



Output Display

- Information** The Signal Generator will output the display information when it is addressed to talk and is not configured to output any other data.
1. The first time the Signal Generator is addressed to talk, it will output the actual display in alphanumeric characters (maximum of 74 characters). (The string length of the alphanumeric display will always be greater than or equal to 25 characters.)
 2. The second time the Signal Generator is addressed to talk, it will output a number, representing the displayed cursor positions, in a binary, weighted sum. (This string length will always be less than 25 characters.)
 3. The third time the Signal Generator is addressed to talk, it will output a number, representing the displayed annunciators, in a binary, weighted sum. (This string length will also always be less than 25 characters.)

Each item in the sequence above will be output again in the same sequence when the Signal Generator is further addressed to talk.

Following is a programming example in BASIC for outputting display information: Output the current display of the Signal Generator (address 19), including the cursor position and annunciators. (Assuming a function was executed to enable you to get the display you want.)

```

10 DIM A$ [74]           ! Define string big enough to handle maximum display
20 ENTER 719; A$         ! Display String
30 ENTER 719; C          ! Cursor Value
40 ENTER 719; N          ! Annunciator Value

```

The Signal Generator is initialized to output the alphanumeric display string first, whenever you execute an instrument function (for example, set AM or frequency). (When you are using Output Display to output messages, the actual front-panel display will be output, not the message code number that would be output if you used "OC", "OE", or "OH".)

The binary weight of the cursor positions are:

$2^1=2$ for the left most cursor, $2^2=4$ for the next cursor to the right, $2^3=8$ for the next cursor to the right, ..., 2_n for the nth cursor position from the left, ..., $2^{25}= 33\ 554\ 432$ for the right most cursor.

The binary weight of the annunciators are provided in the following Table 3-5.

Data Output (cont'd)

Table 3-5. Output Display; Binary Weight of Annunciators

Annunciator	Weighting	Decimal
RMT	2^0	1
LSTN	2^1	2
START (Frequency)	2^2	4
TLK	2^3	8
SRQ	2^4	16
FREQ	2^5	32
REL (Frequency)	2^6	64
EMF	2^7	128
SPCL	2^8	256
SWPNG	2^9	512
HI	2^{10}	1 024
LO	2^{11}	2 048
ΦM	2^{12}	4 096
FM	2^{13}	8 192
AM	2^{14}	16 384
START (Amplitude)	2^{15}	32 768
INT	2^{16}	65 536
EXT	2^{17}	131 072
AC	2^{18}	262 144
DC	2^{19}	524 288
AMPTD	2^{20}	1 048 576
REL (Amplitude)	2^{21}	2 097 152
STOP	2^{22}	4 194 304
MSSG	2^{23}	8 388 608

Example

With a display of:

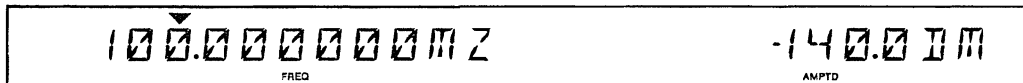

Alphanumeric characters output will be:

100.000000MZ -140.0DM

Cursor value output (4th cursor from the left) will be:

$$2^4 = 16$$

Annunciator value output for FREQ and AMPTD will be:

$$2^5 + 2^{20} = 32 + 1\,048\,576 = 1\,048\,608$$

Outputting the display could be used to output the currently selected special functions, or to output the annunciator value to determine the current modulation source.

Table 3-6. Error Code and Message Recovery Example Program



Table 3-6. Error Code and Message Recovery Example Program

```

10 ! ERROR CODE AND MESSAGE RECOVERY EXAMPLE PROGRAM
20 !   JWT JULY 1984
30 !   EDIT DATE 23 AUG 1984
40 !
50 ! LET Gen=719                                ! DEFINE 8642 ADDRESS
60 !
70 COM /Gen_addr/ Gen                          ! COMMON AREA TO STORE
80 !                                           ! GEN ADDRESS FOR SUB'S
90 !
100 DIM Mssg$(74)                             ! DIMENSION SPACE TO
110 !                                           ! ENTER IN MESSAGES
120 !
130 ENABLE INTR 7;2
140 ON INTR 7 CALL Get_message
150 OUTPUT Gen;"RM134HZ"
160 !
170 !
180 !
190 !
200 CALL User_program
210 !
220 !
230 !
240 !
250 !
260 END
270 !
280 ! SUB PROGRAMM TO POLL THE 8642
290 ! AND PRINT THE MESSAGE CODES
300 !
310 Get_message: SUB Get_message
320 COM /Gen_addr/ Gen
330 LET Byte=SPOLL(Gen)                        ! READ STATUS BYTE
340 IF BIT(Byte,2) THEN CALL Execution        ! CHECK MESSAGE BIT
350 IF BIT(Byte,7) THEN CALL Change          ! CHECK MESSAGE BIT
360 IF BIT(Byte,1) THEN CALL Hardware        ! CHECK MESSAGE BIT
370 ENABLE INTR 7
380 SUBEND
390 !
400 !
410 Execution: SUB Execution
420 COM /Gen_addr/ Gen
430 OUTPUT Gen;"OE"                            ! OUTPUT"OE"COMMAND
440 ENTER Gen;Mssg_code                       ! READ MESSAGE CODE
450 PRINT USING 460;Mssg_code                 ! PRINT MESSAGE CODE
460 IMAGE "EXECUTION ERROR CODE =",K
470 ENTER Gen;Mssg$(1,74)                    ! READ MESSAGE
480 PRINT Mssg$(1,74)                        ! PRINT MESSAGE
490 SUBEND
500 !
510 Change: SUB Change
520 COM /Gen_addr/ Gen
530 OUTPUT Gen;"OC"                            ! OUTPUT"OC"COMMAND
540 ENTER Gen;Mssg_code                       ! READ MESSAGE CODE
550 PRINT USING 560;Mssg_code                 ! PRINT MESSAGE CODE
560 IMAGE "CHANGE CODE =",K
570 ENTER Gen;Mssg$(1,74)                    ! READ MESSAGE
580 PRINT Mssg$(1,74)                        ! PRINT MESSAGE
590 SUBEND
600 !
610 Hardware: SUB Hardware
620 COM /Gen_addr/ Gen
630 OUTPUT Gen;"OH"                            ! OUTPUT"OH"COMMAND
640 ENTER Gen;Mssg_code                       ! READ MESSAGE CODE
650 IF Mssg_code<>0 THEN 690                  ! CHECK IF CODE =0
660 ENTER Gen;Mssg_code                       ! READ MESSAGE CODE
670 PRINT "NO HARDWARE MESSAGE FOUND"        ! PRINT NO MESSAGES
680 GOTO 760
690 PRINT "MESSAGE CODE =",Mssg_code         ! PRINT MESSAGE CODE
700 ENTER Gen;Mssg_code                       ! READ MESSAGE CODE
710 IF Mssg_code<>0 THEN 690                  ! CHECK IF LAST
720 ENTER Gen;Mssg$(1,74)                    ! READ MESSAGE
730 PRINT Mssg$(1,74)                        ! PRINT MESSAGE
740 IF Mssg$(1,19)="END OF MESSAGE LIST" THEN 760 ! LAST MESSAGE ?
750 GOTO 720                                  ! GO FOR NEXT MSGE
760 SUBEND

```



CLEAR

Overview

The Signal Generator responds identically to Selected Device Clear (SDC) and Device Clear (DCL) bus commands by clearing any message or uncompleted entries. For example, a command of FR100 would be cleared because no units terminator has been specified.

Also, with the Clear command, Clear Status Byte occurs, possibly clearing up to 6 status bits.

The Clear command does not affect instrument settings. However, selecting Instrument Preset (IP), Partial Preset (PP), or turning the Power from Standby to On, will reset instrument settings as described in the Detailed Operating Instruction, **Instrument Preset, Partial Preset** (page 3-137.)



REMOTE, LOCAL

Local to

Remote

Transition

The Signal Generator goes remote when it receives the Remote message. The Remote message has two parts:

1. Remote Enable bus control line (REN) set true.
2. Device listen address received once (while REN is true).

The Signal Generator's output signal and all control settings remain unchanged with the local to remote transition, but any uncompleted messages (non-terminated partial entries) are cleared.

LOCAL

Remote to

Local

Transition

The Local message is the way the controller sends the Go To Local (GTL) bus command. The Signal Generator returns to local control when it receives the Local or Clear Lockout/Set Local message. The Signal Generator also returns to the local mode when the front-panel **LOCAL** key is pressed (provided Local Lockout is not in effect). If the instrument is not in local lockout mode, pressing the front-panel **LOCAL** key could interrupt a data transmission and suspend the Signal Generator in an unknown state. (Refer to **Local Lockout, Set Local** on the following page for more information on the Local Lockout function.)



LOCAL LOCKOUT, SET LOCAL

Local Lockout

The Local Lockout message is the way the controller sends the Local Lockout (LLO) bus command. The Signal Generator responds to the Local Lockout message by disabling the front-panel **[LOCAL]** key.

Clear Lockout/ Set Local

The Clear Lockout/Set Local message is the way the controller sets the Remote Enable (REN) bus control line false. The Signal Generator returns to local mode when it receives the Clear Lockout/Set Local message. No instrument settings are changed by the transition from remote to local.

When in local lockout, the Signal Generator can be returned to local only by the controller (using the Local or Clear Lockout/Set Local messages), or by setting the Power switch to Standby and back to on, or by removing the bus cable.

NOTE

Return-to-local while in local lockout can be accomplished by switching the **[POWER]** from STBY to ON. Returning to local control in this way has the following disadvantages:

1. It defeats the purpose and advantages of local lockout (that is, the system controller will lose control of a system element).
2. Instrument configuration is reset to the power-up conditions listed in the Detailed Operating Instruction, **Instrument Preset, Partial Preset** (page 3-137).



SERVICE REQUEST

Overview The Signal Generator uses its internal Status Byte and a Request Service Mask Byte (RQS mask that you set) to determine whether to issue a Service Request (SRQ bus line true).

RQS MASK The RQS mask is an 8-bit byte that you can set to define which bits of the Status Byte will be allowed to cause a service request. (See Figure 3-4 on the following page.) Bits 0 through 5 and 7 of the Status Byte are logically ANDed with bits 0 through 5 and 7 of the RQS mask byte. If the resultant value is not equal to zero, the Signal Generator sets bit 6 of the Status Byte true, which sends a Service Request (SRQ) message to the system controller (SRQ bus line true).

At turn-on or instrument preset, the RQS mask byte is set to zero, effectively disabling or masking all the status bits from causing a service request message.

Changing the 8-bit RQS Mask Byte

- From the Remote Mode:

Send RM, the decimal equivalent of the binary 8-bit byte (a number between 0 and 255), and the terminator, HZ.

- From the Local Mode:

Select RQS MASK (), the decimal equivalent of the binary 8-bit byte and any terminator (such as).

Example

Enable status bits 0 (End of Sweep), 1 (Hardware Error), and 7 (Parameters Changed) to cause a service request (SRQ bus line true) by unmasking those bits; that is, set the Signal Generator's RQS mask to binary 10000011 (decimal 131).

Set the mask value to: binary 10000011 = decimal 131

Local operation: RQS MASK ()

Remote operation: RM 131 HZ

A Service Request can be generated in either the local or remote mode. To determine which status bit caused the service request, refer to Table 3-7, HP-IB Status Byte Bit Definitions, on page 3-30. The Status Byte can be read only by doing a serial poll via HP-IB (refer to page 3-29).

Clearing the Service Request Message

The Service Request message can be cleared by masking the "set" bits in the Status Byte using the RQS mask. If the condition which caused SRQ to be pulled has been resolved, the Service Request message can be cleared with any of the following actions for clearing the Status Byte:

Sending Clear Status (CS).

Sending Instrument Preset (IP).

Sending Device Clear or Selected Device Clear.

Switching Power from Standby to On.

Resetting the individual "set" bits. (Refer to Table 3-7 on page 3-30.)

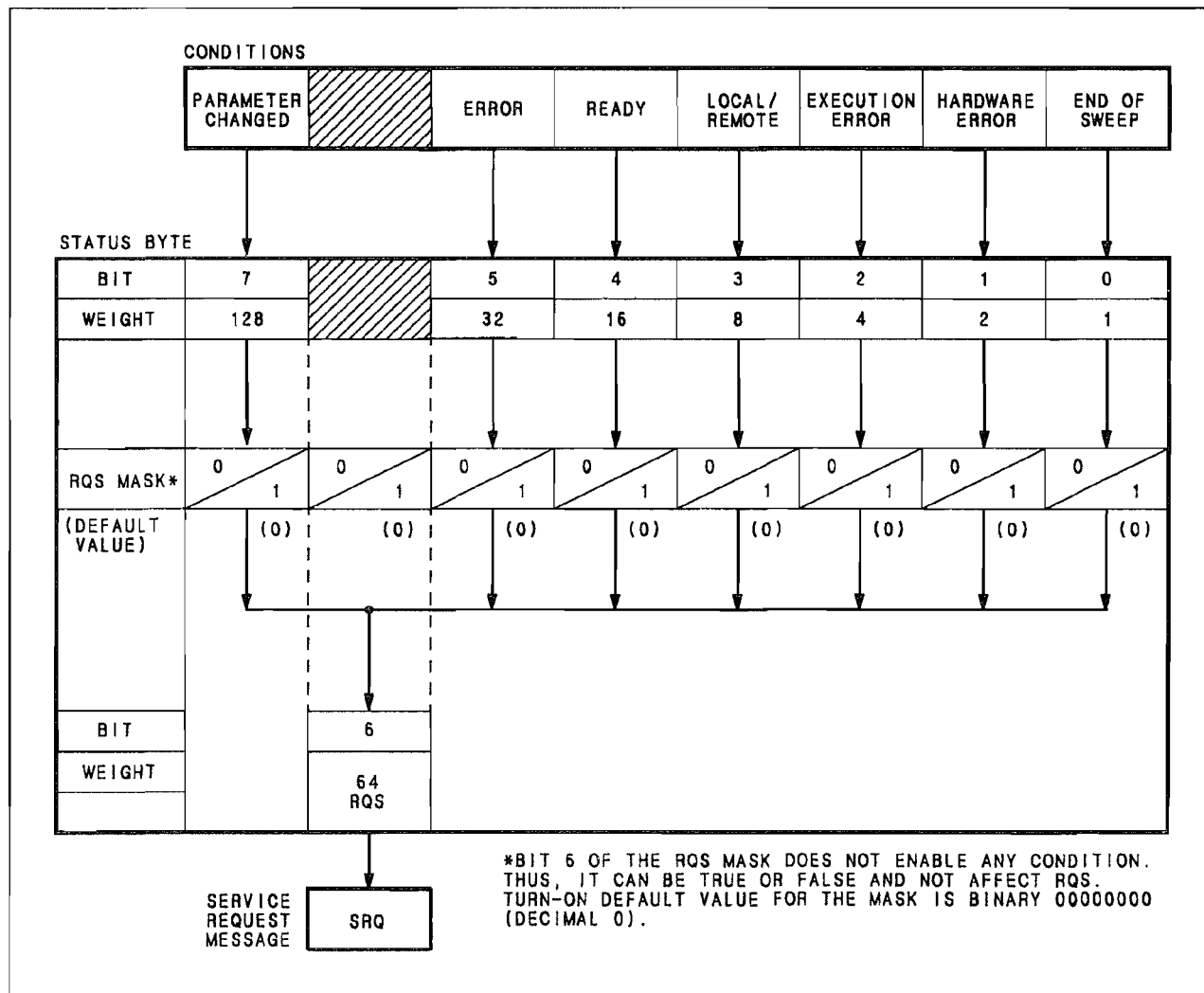

Figure 3-4. The Status Byte and RQS Mask



STATUS BYTE

Overview The 8642A/B Status Byte consists of one 8-bit byte which reflects Signal Generator status. All 8 status bits are updated whether the Signal Generator is in local or remote mode.

Each bit of the Status Byte monitors a particular aspect of the Signal Generator's operation. Table 3-7, HP-IB Status Byte Bit Definitions (on the following page), details the operating conditions which are monitored by the 8642 Status Byte.

The Status Byte can either be used to cause a Service Request or simply be read to monitor the Signal Generator's operating status.

Reading the Status Byte

To read the Signal Generator's Status Byte, the controller must send the Serial Poll Enable bus command and address the Signal Generator to talk. For example:

Program Statement (in BASIC)

```
10 S = SPOLL (719)
```

If the RQS bit is not set, the Status Byte will reflect the current status of the instrument. If the RQS bit is set, the Status Byte will reflect the status of the instrument when the RQS bit was first set (or when the Status Byte was last read with RQS set). To actually get the current status of the instrument, the Status Byte should be read again. Note that the act of reading the Status Byte (alone) does not clear any status bits.

Clearing the Status Byte

If the instrument does not have an unresolved hardware error, the Status Byte will be "cleared" by executing any of the following:

- Sending Clear Status (CS).
- Sending Instrument Preset (IP).
- Sending Device Clear or Selected Device Clear.
- Switching the Power from Standby to On.

You can also clear the Status Byte by clearing the individual status bits. Refer to Table 3-7 on the following page.

NOTE

Bits 3 (Local/Remote) and 4 (Ready) are not affected by "clearing" the Status Byte. They always output their actual values.



Status Byte (cont'd)

Table 3-7. HP-IB Status Byte Bit Definitions

Bit	HP-IB Operating Condition	Condition	Comments
0	END OF SWEEP	Single sweep finished.	Reset with auto, manual, or a new single sweep, or sweep mode off. ^{1,2}
1	HARDWARE ERROR	Instrument out-of-lock, reverse-power tripped, or instrument firmware malfunction.	Reset with an Output Hardware Error message to the 8642A/B (HP-IB program code "OH"). ^{1,2} More than one Hardware Error message may be present. After "OH" is executed, one error message code or string is output with each address to talk. (The Detailed Operating Instruction, Messages , lists the error codes with their respective messages.) To properly retrieve all Hardware Error information, refer to the example program in Data Output in this HP-IB information section.
2	EXECUTION ERROR	Syntax or function execution error.	Reset with an Output Execution error message to the 8642A/B (HP-IB program code "OE"). ^{1,2} Error code that caused bit to be set can be determined by reading the Output Execution Error code or string. Refer to the example program in Data Output in this HP-IB information section.
3	LOCAL/REMOTE	Instrument in local operation.	Reset when remote. Can be used to detect a front-panel SRQ (emulated by selecting the LOCAL key if not in Local Lockout). ²
4	READY	Typically always set.	The Status Byte must actually be read with this bit set for the instrument to have completed the processor delay time part of the setting change which might not include the analog settling time.
5	ERROR	Logical OR of bits 1 and 2.	Reset when bits 1 and 2 are reset. ¹
6	RQS (IEEE-488)	RQS mask is ANDed with the Status Byte and the result is not equal to 0 (refer to Service Request for more information).	Reset when the RQS mask ANDed with the Status Byte (ignoring bit 6) equals 0.
7	PARAMETER CHANGED	Previous setting has been automatically changed; for example, FM is turned off when ϕM becomes active.	Reset with an output Parameter Changed message (HP-IB program code "OC"). ^{1,2} Parameter that was changed can be determined by transmitting the Output Parameter Changed message code or string. Refer to the example program in Data Output in this HP-IB information section.

¹Also reset with IP, CS, Device Clear, Selected Device Clear, Power On. (Bit 1 is cleared only if all hardware errors are resolved.)

²If that bit was causing SRQ to be pulled, you must also read the Status Byte again to actually reset that bit. (This second reading will still show the error because the error is cleared only after the reading.)



ADDITIONAL HP-IB INFORMATION

Abort

Abort abruptly terminates all listener/talker activity on the interface bus, using the Interface Clear (IFC) bus line, and prepares all instruments to receive a new command from the controller. Typically this is an initialization command used to place the bus in a known starting condition. The Signal Generator stops talking or listening when it receives the Abort message.

Trigger

The Signal Generator does not respond to the Trigger message.

Status Bit

The Signal Generator does not implement parallel poll operations and therefore cannot send a Status Bit message.

Controller Capabilities; Self Test and Calibration

The Signal Generator can be configured as a system controller to perform various self-test and self-calibration routines with a system voltmeter and the HP 8902A Measuring Receiver (and an optional printer). Refer to Section IV in the Service Manual for a detailed description of these routines.

Display Control Via HP-IB

Selecting the **SHIFT** key twice when in the local mode will display the instrument settings last selected. In the remote mode, you can send SHSH to achieve this same effect. (This may be useful when outputting display information.)

Remote Indicators

The Signal Generator displays **HP-IB** annunciators to indicate its current HP-IB status:

RMT	When remote operation is selected
LSTN	When addressed to listen
TLK	When addressed to talk
SRQ	When pulling the SRQ line (with the RQS bit set in the Status Byte)

Disabling the Listen Addressed State

The Signal Generator remains addressed to listen until:

- It is addressed to talk,
- It receives an abort message,
- It receives a universal unlisten command, or
- Until the Power is switched from Standby to On.

Disabling the Talk Addressed State

The Signal Generator remains addressed to talk until:

- It is addressed to listen,
- It receives an abort message,
- It receives some other device's talk address,
- It receives a universal untalk command, or
- Until the Power is switched from Standby to On



HP-IB CODES SUMMARY

Table 3-8. Signal Generator Function to HP-IB Code

Parameter	Code	Page	Parameter	Code	Page
Frequency			Units (Cont'd)		
Frequency	FR ¹	3-39	radian	RD	3-119
Start Frequency (Sweep)	FA ¹	3-49	second	SC	3-52, 3-85
Stop Frequency (Sweep)	FB ¹	3-49	millisecond	MS	3-52, 3-85
Amplitude			Sweep		
Amplitude	AP ¹	3-69	Sweep Time	ST ¹	3-52, 3-85
Start Amplitude (Sweep)	AA ¹	3-83	Auto Sweep	SA ²	3-51, 3-84
Stop Amplitude (Sweep)	AB ¹	3-83	Manual Sweep	SM ²	3-51, 3-84
EMF Mode	EMON, EMOF	3-71	Single Sweep	SG ²	3-51, 3-84
Modulation			Relative		
AM Depth	AM ¹	3-97	Reference Set	RS ²	3-46, 3-78
FM Deviation	FM ¹	3-105	Relative Zero	RZ ²	3-45, 3-77
ΦM Deviation	PM ¹	3-119	Relative Off	RF ²	3-47, 3-81
Pulse	PLON, PLOF	3-127	Other		
Modulation Oscillator			Instrument Preset	IP	3-138
Modulation Frequency	MF ¹	3-131	Partial Preset	PP	3-139
Modulation Output Level	ML ¹	3-131	Special Function	SP	3-167
Modulation Source			Message	MG	3-179
Internal	NT ²	3-95	Output Hardware Error	OH	3-17, 3-193
External AC	XA ²	3-95	Output Execution Error	OE	3-16, 3-184
External DC	XD ²	3-95	Output Parameters		
Internal + External AC	BA ²	3-95	Changed	OC	3-16, 3-182
Internal + External DC	BD ²	3-95	Output Active Function	OA ²	3-18
Data			Write Service Request Mask	RM	3-27
Numerals 0-9	0-9		Output HI,LO		
Decimal point	.		Annunciator Status	OL ²	3-20
Back Space	BS		Clear Status Byte	CS	3-29
Units			Step Up	UP ^{2,3}	3-149
dBm	DM or DB		Step Down	DN ^{2,3}	3-149
dB	DB or DM		Increment Set	IS ²	3-149
Volt	VL		Knob, cursor left	KL ²	3-141
mV	MV		Knob, cursor right	KR ²	3-141
μV	UV		Knob Hold	KHON ² , KHOF	3-143
dBμV	DU		Knob Increment	KI	3-142
GHz	GZ		Help	HP	3-167
MHz	MZ		Help Off	HO	3-167
kHz	KZ		RF Off/On	R0, R1	3-72
Hz	HZ		Off, On	OF ² , ON ²	
%	PC	3-97	Entry Off	EO	3-153
			Sequence	SQ	3-161
			Set Sequence	SS	3-161
			Save	SV	3-157
			Recall	RC	3-159

¹Active function code.

²Function should be preceded by an active function code. For example, internal modulation source for AM is coded AMNT.

³These codes will sometimes not need to be preceded by an active function code; for example, when using UP or DN with SV, RC, HP, or SM.



Table 3-9. Signal Generator HP-IB Code to Function

Code	Parameter	Page	Code	Parameter	Page
AA ¹	Start Amplitude (Sweep)	3-83	NT ²	Internal	3-95
AB ¹	Stop Amplitude (Sweep)	3-83	OA ²	Output Active Function	3-18
AM ¹	AM Depth	3-97	OC	Output Parameters Changed	3-16, 3-182
AP ¹	Amplitude	3-69	OE	Output Execution Error	3-16, 3-184
BA ²	Internal + External AC	3-95	OF ² ,		
BD ²	Internal + External DC	3-95	ON ²	Off, On	
BS	Back Space		OH	Output Hardware Error	3-17, 3-193
CS	Clear Status Byte	3-29	OL ²	Output HI,LO Annunciator Status	3-20
DB	dB or dBm		PC	%	3-97
DM	dBm or dB		PLON,		
DN ^{2,3}	Step Down	3-149	PLOF	Pulse	3-127
DU	dB _μ V		PM ¹	ΦM Deviation	3-119
EMON,			PP	Partial Preset	3-139
EMOF	EMF Mode	3-71	R0,R1	RF Off/On	3-72
EO	Entry Off	3-153	RC	Recall	3-159
FA ¹	Start Frequency (Sweep)	3-49	RD	radian	3-119
FB ¹	Stop Frequency (Sweep)	3-49	RF ²	Relative Off	3-47, 3-81
FM ¹	FM Deviation	3-105	RM	Write Service Request Mask	3-27
FR ¹	Frequency	3-39	RS ²	Reference Set	3-46, 3-78
GZ	GHz		RZ ²	Relative Zero	3-45, 3-77
HO	Help Off	3-167	SA ²	Auto Sweep	3-51, 3-84
HP	Help	3-167	SC	second	3-52, 3-85
HZ	Hz		SG ²	Single Sweep	3-51, 3-84
IP	Instrument Preset	3-138	SM ²	Manual Sweep	3-51, 3-84
IS ²	Increment Set	3-149	SP	Special Function	3-167
KHON ² ,			SQ	Sequence	3-161
KHOF	Knob Hold	3-143	SS	Set Sequence	3-161
KI	Knob Increment	3-142	ST ¹	Sweep Time	3-52, 3-85
KL ²	Knob, cursor left	3-141	SV	Save	3-157
KR ²	Knob, cursor right	3-141	UP ^{2,3}	Step Up	3-149
KZ	kHz		UV	μV	
MF ¹	Modulation Frequency	3-131	VL	Volt	
MG	Message	3-179	XA ²	External AC	3-95
ML ¹	Modulation Output Level	3-131	XD ²	External DC	3-95
MS	millisecond	3-52, 3-85	0-9	Numerals 0-9	
MV	mV		.	Decimal point	
MZ	MHz				

¹Active function code.

²Function should be preceded by an active function code. For example, internal modulation source for AM is coded AMNT.

³These codes will sometimes not need to be preceded by an active function code; for example, when using UP or DN with SV, RC, HP, or SM.



HP-IB RELATED FRONT-PANEL KEYS

1



This function enables you to view or set the HP-IB address from the front panel.

2



This key enables you to return to local from remote.

3

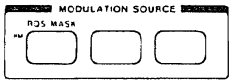

You can view or set the RQS mask from the front panel by selecting the keys **SHIFT** **INT**.

Figure 3-5. HP-IB Related Front-Panel Keys



HP-IB RELATED TERMS

active function prefix

Many HP-IB codes should not be entered without being prefixed by an active function code. For a list of the active function codes and the codes that should be prefixed with an active function code, refer to Table 3-8, Signal Generator Function to HP-IB Code (page 3-32), or Table 3-9, Signal Generator HP-IB Code to Function (page 3-33).

alphanumeric

The 8642A/B has an alphanumeric display; that is, the display can show both alphabetic and numeric characters.

ASCII

ASCII is an abbreviation for American Standard Code for Information Interchange (pronounced "ask-ee").

RQS

RQS (request service) is from the Signal Generator's point of view. The request service (RQS) bit is in the 8642A/B Status Byte. This bit affects when the service request (SRQ) line is pulled on the HP-IB interface. Refer to page 3-27.

SRQ

SRQ is from the HP-IB controller's point of view. The service request (SRQ) line is a signal line on the HP-IB interface. This line is pulled low by the Signal Generator when it is requesting service. Refer to page 3-27.

The SRQ annunciator in the display of the 8642A/B indicates that this Signal Generator is pulling the HP-IB SRQ line low.

RF FREQUENCY CONTENTS

Figure 3-6. RF Frequency-Related Functions	3-38	HP-IB Codes	3-47
RF FREQUENCY	3-39	Comments	3-47
Table 3-10. RF Frequency Operating		RF FREQUENCY SWEEP	3-49
Characteristics	3-39	Table 3-12. RF Frequency Sweep Operating	
Table 3-11. RF Frequency Band Ranges	3-39	Characteristics	3-49
FREQ	3-40	How to Select Stepped Frequency Sweep	3-50
How to Set RF Frequency	3-40	SPCL 123	3-50
SPCL 8	3-41	How to Select Phase Continuous Frequency	
How to Select the Het Band		Sweep (Special Function 123)	3-50
(Special Function 8)	3-41	START FREQ, STOP FREQ	3-50
HP-IB Codes	3-42	How to Set Start and Stop Frequencies	3-50
Comments	3-42	How to Stop the Sweep	3-50
Related Special Functions	3-42	AUTO, MANUAL, SINGLE	3-51
240. Decrement Frequency by 0.1 Hz	3-42	How to Select a Sweep Mode	3-51
241. Increment Frequency by 0.1 Hz	3-42	TIME	3-52
242. Phase Decrement 1 Degree	3-42	How to Set Sweep Time	3-52
243. Phase Increment 1 Degree	3-42	How to Set Sweep Time for Stepped	
244. Phase Decrement 5 Degrees	3-42	Frequency Sweep (Using Sweep Time	
245. Phase Increment 5 Degrees	3-42	to Set Frequency Step Size and	
250. Phase Adjustment from Knob and		Number of Steps)	3-53
Step Up, Step Down Keys	3-42	How to Set Sweep Time for Phase	
RELATIVE RF FREQUENCY	3-45	Continuous Frequency Sweep	
REL ZERO	3-45	(Understanding Limitations Between	
How to Set the Current Output Frequency		Sweep Spans and Sweep Times;	
Setting to Be the Frequency Reference	3-45	Also, How to Set a Specific Number	
REF SET	3-46	of X-Axis Steps)	3-60
How to Set a Reference to a Specific		HP-IB Codes	3-64
Frequency	3-46	Comments	3-64
How to Reference to the Signal Generator's		Related Special Functions	3-65
Last-Selected Reference	3-46	119. Disable Settling	3-65
How to Display the Current		121. Sweep Up and Down On	3-66
Frequency Reference	3-46	Figure 3-7. Sweep Waveforms	3-66
REL OFF	3-47		
How to Turn Off the Frequency Relative			
Mode	3-47		

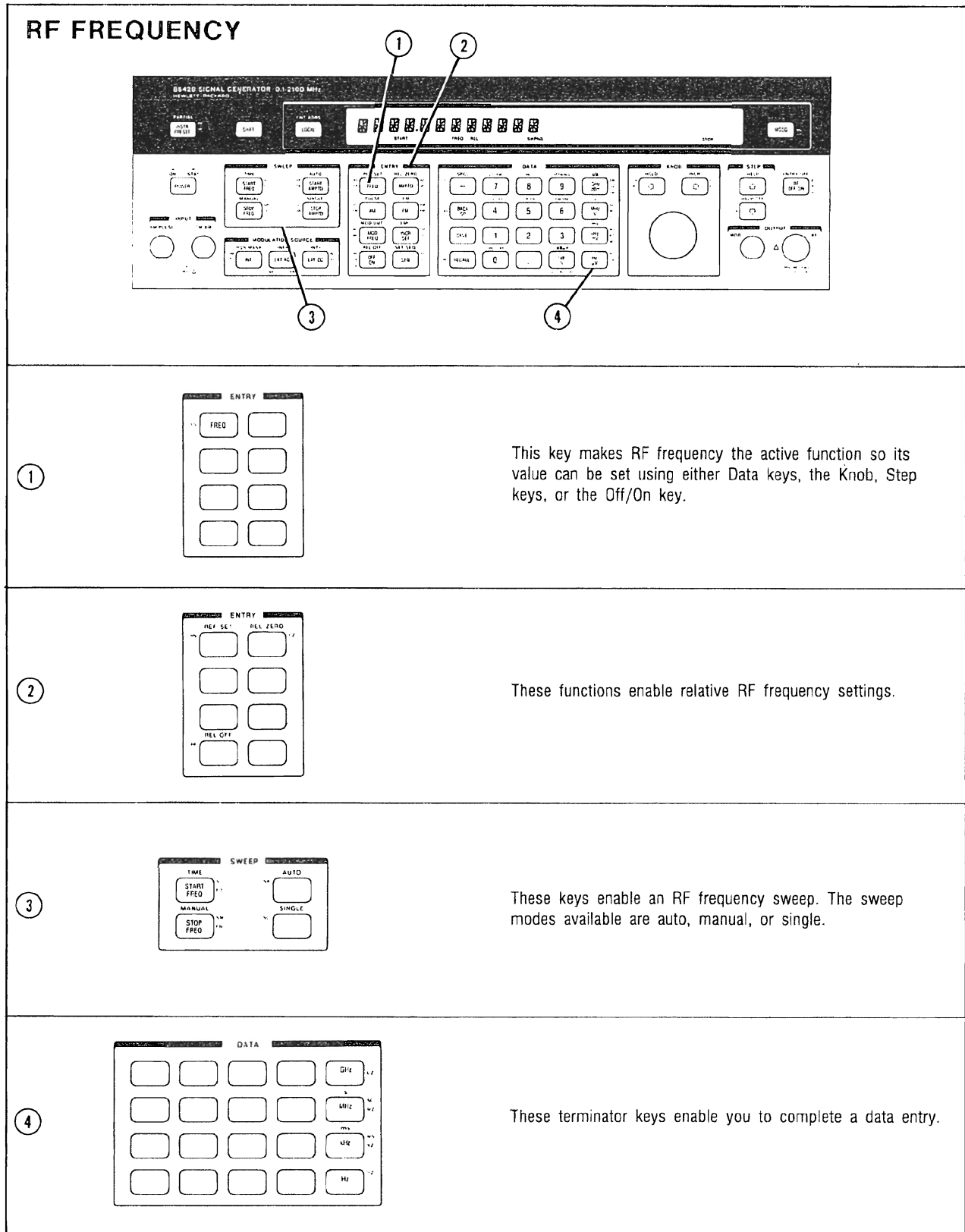

Figure 3-6. RF Frequency-Related Functions

RF FREQUENCY

Description

The Signal Generator's fundamental synthesized frequency range of 528.750001 to 1057.500000 MHz is translated over the RF output frequency range listed below. The output frequency range is obtained through frequency division and heterodyne conversion (and frequency multiplication for the 8642B.)

Table 3-10. RF Frequency Operating Characteristics

Electrical Characteristics	Performance Limits	Conditions
Frequency Range	0.100000 to 1057.500000 MHz 0.100000 to 2115.000000 MHz	8642A 8642B
Underrange	0.000001 to 0.099999 MHz*	
Resolution	1 Hz (0.1 Hz with Special Function 240 or 241)	
Frequency Switching Time	85 ms	To within 100 Hz of final frequency
*Below 10 kHz, the output level drops rapidly.		

The divide bands divide from the fundamental band (divide band 9) as shown in Table 3-11 below. Although the heterodyne band (Het Band) covers a frequency range that is included in divide bands 1 through 6 (0.100000 to 132.187500 MHz), the heterodyne conversion technique allows improved modulation characteristics and wider sweep spans for Phase Continuous Frequency Sweep.

Table 3-11. RF Frequency Band Ranges

Carrier Frequency (MHz)	Band	Divide Number
1057.500001 to 2115.000000	10 (8642B only)	0.5
528.750001 to 1057.500000	9	1
264.375001 to 528.750000	8	2
132.187501 to 264.375000	7	4
66.093751 to 132.187500	6	8
33.046876 to 66.093750	5	16
16.523438 to 33.046875	4	32
8.261719 to 16.523437	3	64
4.130860 to 8.261718	2	16
0.100000 to 4.130859	1	256
0.100000 to 132.187500	HET	1

RF Frequency (cont'd)

The divide bands and the Het band have the following advantages:

Divide Bands:

- Lower phase noise
- Higher output level specifications

Het Band:

- Greater stereo separation with dc-coupled FM
- Wider FM/ Φ M deviation at frequencies less than 132.187501 MHz
- Greater AM rates in the range from 4.130860 to 33.046875 MHz
- Wider frequency spans in Phase Continuous Frequency Sweep (Special Function 123).

Refer to Table 1-1, Specifications (which starts on page 1-7), for the specific differences between the Het band and the divide bands.

The divide bands are normally selected since they have the lowest possible phase noise. However, the Signal Generator will automatically switch to or from the Het band if a setting crosses either a divide band's maximum FM or Φ M deviation limits or a divide band's frequency span limits in Phase Continuous Frequency Sweep. In other words, if your settings are not possible in a divide band but are possible in the Het band (at the identical RF frequency), the Signal Generator will sometimes automatically switch to the Het band to allow your settings. However, selecting Special Function 8, Prefer Heterodyne Band, forces the Signal Generator to always operate in the Het band whenever RF frequency is less than 132.187501 MHz (regardless of FM or Φ M deviation or Phase Continuous Frequency Sweep span limits). This special function prevents the Signal Generator from switching to the divide bands from the Het band when the settings would allow operation in the divide bands.

Refer to Figures 3-12 and 3-13 (page 3-106) for the FM deviation limits in each frequency band. Refer to **Modulation, Φ M** (page 3-119) for the Φ M deviation limits in each frequency band. Refer to **RF Frequency Sweep** (page 3-49 and 3-60) for information about frequency span limitations in Phase Continuous Frequency Sweep.

Procedure

Note: Put the instrument in its initialized state by selecting **[INSTR PRESET]**.

FREQ

How To Set RF Frequency

RF frequency is set by selecting the RF frequency function and then entering the desired frequency:

[FREQ] and the value of the desired RF frequency (up to 10 digits) (in GHz, MHz, kHz, or Hz).

Example

Set RF frequency to 1.23 MHz.

	ENTRY	DATA
LOCAL (keys)	[FREQ]	[1] [.] [2] [3] [MHz]
HP-IB (program codes)	FR 1.23 MZ	

RF Frequency (cont'd)

Display

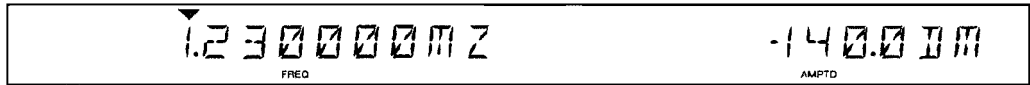

Frequency has been set to 1.230000 MHz. The cursor above the frequency display setting indicates frequency is the active function.

SPCL 8

How To Select the Het Band (Special Function 8)

Either you can select the Het band or the Signal Generator will select Het band operation as described below.

- Selecting Special Function 8 configures the instrument to operate in the Het band whenever the RF frequency is less than 132.187501 MHz, regardless of FM or Φ M deviation or Phase Continuous Frequency Sweep span:

SPCL (**SHIFT**) (**-**) (**8**).

Turn off Special Function 8:

SPCL (**SHIFT**) (**-**) (**2**) (**0**) (**8**).

- The Signal Generator will automatically select the Het band if you select a combination of RF frequency and FM or Φ M deviation, or a Phase Continuous Frequency Sweep span beyond the capabilities of the Signal Generator's divide bands. The Signal Generator automatically switches back to a divide band when the combination of functions selected allow divide band operation (unless the Het band is selected with Special Function 8).

Example

Configure the Signal Generator to operate in the Het band at frequencies less than 132.187501 MHz, regardless of FM or Φ M deviation or Phase Continuous Frequency Sweep span settings.

LOCAL (keys)		DATA
	SHIFT	SPCL - HET 8
HP-IB (program codes)	SP 8	

Display

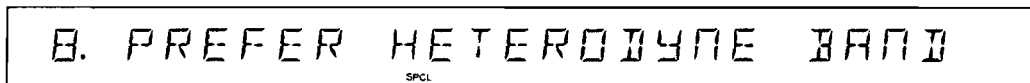

After entering SPCL (**8**), the Signal Generator displays the number and description of the Special Function just entered. (To return the display to instrument settings previously displayed, press the **SHIFT** key twice.) The SPCL annunciator indicates the current use of a Special Function.

RF Frequency (cont'd)

HP-IB Codes

Keys	Codes
FREQ	FR
GHz	GZ
MHz	MZ
kHz	KZ
Hz	HZ
SPCL	SP

Comments

Underranging Specified Frequency

RF frequencies as low as 1 Hz can be selected. However, the Signal Generator's signal characteristics are not specified below 100 kHz (below 10 kHz the output level falls rapidly). The Signal Generator will not allow overrange settings (settings above 1057.500000 MHz for the 8642A, or above 2115.000000 MHz for the 8642B).

Selecting the Het Band Increases Specified AM Rates

AM depths are specified for depths less than or equal to 90% at a maximum rate of 20 kHz (in the RF frequency range from 4.130860 to 33.046875 MHz). You can increase specified AM rates in this carrier frequency range from a maximum of 20 kHz to a maximum of 100 kHz by selecting Special Function 8 (Prefer Het Band). (The Signal Generator will not automatically select the Het Band in this case.)

Related Special Functions

240. Decrement Frequency by 0.1 Hz

241. Increment Frequency by 0.1 Hz

These functions change the RF signal's output frequency in 0.1 Hz steps each time the special function is selected. For example, selecting SPCL (**SHIFT** **-**) **2** **4** **↑** increments output frequency by 0.1 Hz.

The Signal Generator cannot directly display this RF frequency increase or decrease in its normal frequency display, so it indicates the change with a lighted MSSG annunciator. Scrolling through the message list using the **MSSG** key will then display the amount of frequency change in the form, "RF.FREQ=DISPLAY -0.2 HZ .142". This message means that the actual output frequency is the displayed value minus 0.2 Hz. These 0.1 Hz Special Functions are disabled when you set a new frequency value.

242. Phase Decrement 1 Degree

243. Phase Increment 1 Degree

244. Phase Decrement 5 Degrees

245. Phase Increment 5 Degrees

These functions change the RF signal's output phase by the indicated amount each time the special function is selected. For example, selecting SPCL (**SHIFT** **-**) **2** **4** **4** **4** decrements output phase by 5 degrees. The execution of this particular special function is indicated by the special function verification display which reads "244. PHASE DECR 5 DEGREES".

250. Phase Adjustment from Knob and Step Up and Step Down Keys. This function enables control over the RF signal's output phase in one degree steps using either the Knob or the Step keys.

RF Frequency (cont'd)

Related Operating Instructions

Refer to **Relative RF Frequency** (page 3-45) for information on designating a particular frequency as a reference frequency and on displaying all subsequent RF frequencies as offsets from that reference.

Refer to **RF Frequency Sweep** (page 3-49) for information on selecting a frequency sweep.

Refer to **Knob** (page 3-141) and **Step, Increment Set** (page 3-149) for information on using these to modify settings.

Refer to **Operating Messages** (page 3-177) if the instrument displays a message you want clarified.

Refer to **Special Functions** (page 3-165) for information about the way these are accessed.

RELATIVE RF FREQUENCY

Description Relative Frequency mode enables you to display the output frequency relative to a reference frequency. This function could be useful, for example, in setting a current frequency to be displayed as an offset from an IF frequency.

Settings for the relative frequency mode range from -2115 to 2115 MHz.

The Reference Set function sets the current display to read as an offset from a specific frequency reference. (The Reference Set function can also be used to display the current frequency reference.) The Relative Zero function sets the current frequency setting to be the frequency reference.

Once a frequency reference is selected, all subsequent frequency entries are displayed as relative frequencies in terms of MHz above or below the frequency reference. This condition exists until the Relative Frequency mode is turned off.

The output frequency is equal to the displayed frequency plus the reference frequency.

Procedures Note: Put the instrument in its initialized state by selecting **INSTR PRESET**.

REL ZERO

How to Set the Current Output Frequency Setting to Be the Frequency Reference

Setting the current output frequency as the frequency reference causes the frequency setting display to become 0.000000 MHz relative:

FREQ REL ZERO (**SHIFT** **AMPTD**).

Example

Configure the front-panel display to read each subsequent frequency relative to a current frequency of 500 MHz.

First select **INSTR PRESET** and set the RF frequency to 500 MHz, then perform the following steps.

	ENTRY		ENTRY
LOCAL (keys)	FREQ	SHIFT	REL ZERO AMPTD
HP-IB (program codes)	FRRZ		

Relative RF Frequency (cont'd)

Display

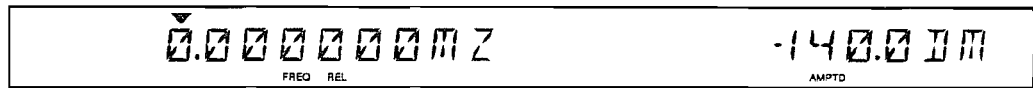

The FREQ REL annunciators indicate that the frequency display is relative. All subsequent frequency settings will be entered and displayed as MHz relative to the frequency reference of 500 MHz. The absolute output frequency is the displayed frequency plus the frequency reference.

REF SET

How to Set a Reference to a Specific Frequency

Setting a specific RF frequency as the frequency reference causes subsequent frequency settings to display the current output frequency as MHz relative to the frequency reference.

[FREQ] REF SET (**[SHIFT]** **[AMPTD]**) and the value of the desired reference frequency (in GHz, MHz, kHz, or Hz).

Example

With a current RF frequency output of 100 MHz, configure the front-panel to allow entry and display of all frequency setting values as an offset from a 1 MHz frequency reference.

First select **[INSTR PRESET]**. Then perform the following steps:

	ENTRY		ENTRY	DATA
LOCAL (keys)	[FREQ]	[SHIFT]	REF SET [FREQ]	[1] [MHz V]
HP-IB (program codes)	FRRS 1 MZ			

Display

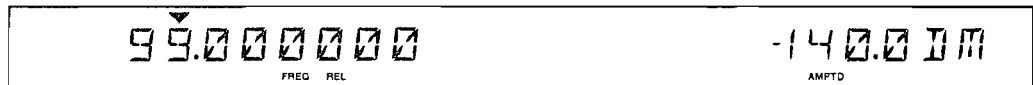

The FREQ REL annunciators indicate the frequency display is relative to a reference frequency. The displayed frequency is 99 MHz (relative); the absolute output frequency is the displayed frequency plus the frequency reference (99 MHz + 1 MHz = 100 MHz).

How to Reference to the Signal Generator's Last-Selected Reference

Turn on the relative frequency mode from the absolute frequency mode by setting the frequency reference to the last-selected value:

[FREQ] REF SET (**[SHIFT]** **[FREQ]**) **[OFF ON]**

How to Display the Current Frequency Reference

[FREQ] REF SET (**[SHIFT]** **[FREQ]**)

Relative RF Frequency (cont'd)

REL OFF

How to Turn Off the Frequency Relative Mode

FREQ REL OFF (**SHIFT** **OFF ON**), or
FREQ REF SET (**SHIFT** **FREQ**) **OFF ON**

HP-IB Codes

Keys	Codes	Keys	Codes
REF SET	FRRS	GHz	GZ
REL ZERO	FRRZ	MHz	MZ
REL OFF	FRRF	kHz	KZ
FREQ	FR	Hz	HZ
OFF ON	FRRSOF, FRRSON		

Comments

Range of Relative RF Frequency Settings

Allowable settings for the frequency reference when using either the 8642A or 8642B range from -2115 to 2115 MHz.

(When the relative frequency display is less than or equal to -2000 MHz, the display is shifted to the right and the 1 Hz (0.0000001 MHz) digit becomes "hidden" under the "M" of the MZ terminator. Then, with the cursor over the 1 Hz digit, the display resembles a Knob Hold condition because the cursor would be over the "M" of the MZ terminator during Knob Hold also. Knob Hold is discussed on Page 3-143.)

RF Frequency Settings Interact with Other Instrument Settings

Some settings are limited by the interaction of coupled functions (for example, FM deviation and RF frequency). Refer to the appropriate Detailed Operating Instruction for setting limitations, and be aware that any restrictions are due to the absolute output frequency, not the relative frequency setting.

Relative RF Frequency Sweep

It is not possible to set an RF frequency sweep in relative units.

Related Operating Instructions

Refer to **RF Frequency** (page 3-42) for additional comments that apply to relative frequency. Also refer to page 3-42 for information on changing RF frequency by 0.1 Hz increments (Special Functions 240, 241) and for information on incrementing or decrementing RF output phase in 1 or 5 degree increments (Special Functions 242 through 245 and 250).

Refer to **Knob** (page 3-141) and **Step, Increment Set** (page 3-149) for information on using these to modify settings.

Refer to **Operating Messages** (page 3-177) if the instrument displays a message you want clarified.

Refer to **Special Functions** (page 3-165) for information about the way these are accessed.

RF FREQUENCY SWEEP

Description

Two types of frequency sweep are available. Stepped Frequency Sweep sweeps from a start end-point to a stop end-point in linearly spaced, incremental steps. Phase Continuous Frequency Sweep (Special Function 123) sweeps from a start end-point to a stop end-point in a linear, phase continuous manner.

Sweep step size is automatically selected based on the frequency span (which is the absolute value of the start frequency minus the stop frequency) and the sweep time. Although step size for the Stepped Frequency Sweep cannot be directly set, this operating instruction provides ways to calculate a sweep time to enable you to select a particular step size or number of steps

Table 3-12. RF Frequency Sweep Operating Characteristics

Electrical Characteristics	Performance Limits	Conditions
Digitally Stepped Frequency Sweep Range Time	0.100000 to 1057.500000 MHz ¹ 0.100000 to 2115.000000 MHz ¹ 275 ms minimum 999s maximum	8642A 8642B
Phase Continuous Frequency Sweep Maximum Sweep Span Time	800.000 kHz (8642B only) 400.000 kHz 200.000 kHz 100.000 kHz 50.000 kHz ² 25.000 kHz ² 12.500 kHz ² 6.250 kHz ² 3.125 kHz ² 25.000 kHz ² 400.000 kHz	End-points can be outside the band but (Start Frequency + Stop Frequency) ÷ 2 must be within the band. 1057.500001 to 2115.000000 MHz 528.750001 to 1057.500000 MHz 264.375001 to 528.750000 MHz 132.187501 to 264.375000 MHz 66.093751 to 132.187500 MHz 33.046876 to 66.093750 MHz 16.523438 to 33.046875 MHz 8.261719 to 16.523437 MHz 4.130860 to 8.261718 MHz 0.100000 to 4.130859 MHz 0.100000 to 132.187500 MHz ³
X Axis Output	0 to 10 Vdc	±10%
Z Axis Output	TTL Positive True	For crt display blanking during retrace ⁴
¹ In AUTO sweep mode, it is not possible to set start and stop end-points if one end-point is less than 4.130860 MHz (band 2) with a second end-point greater than 132.187500 MHz (band 6). Also, it is not possible to set a sweep across 1057.500000 MHz (8642B only) ² Maximum end-point separation may be increased up to that shown for the HET band by selecting a frequency span larger than the span shown here. HET band can also be selected with Special Function 8. ³ The HET Band ⁴ Buffer this output in order to use the Z-axis output with a plotter for pen lift		

RF Frequency Sweep (cont'd)

Procedures Note: Put the instrument in its initialized state by selecting **INSTR PRESET**.

How to Select Stepped Frequency Sweep

Stepped Frequency Sweep is turned on by selecting the sweep mode (auto, manual, or single), sweep time, and the start and stop frequencies (procedures for selecting these parameters are described below). Note that if the sweep mode has not been selected since the last time Instrument Preset has been selected, auto sweep is automatically selected and causes the Signal Generator to begin sweeping immediately after end-points are set. (The SWPNG annunciator indicates that a sweep is occurring.) If Stepped Frequency Sweep is desired but Phase Continuous Frequency Sweep (Special Function 123) is on, Phase Continuous Frequency Sweep Off (Special Function 223) must be selected. However, before Special Function 223 can be selected, one of the start or stop frequencies must be turned off (using a procedure from "How to Stop the Sweep" below).

SPCL 123

How to Select Phase Continuous Frequency Sweep (Special Function 123)

Phase Continuous Frequency Sweep is turned on by first selecting Special Function 123, then, by selecting the sweep mode (auto, manual, or single), sweep time, and start and stop frequencies (procedures for selecting these parameters are described below). Note that if the sweep mode has not been selected since the last time Instrument Preset has been selected, auto sweep is automatically selected and causes the Signal Generator to begin sweeping immediately after end-points are set. (The SWPNG annunciator indicates that a sweep is occurring.) If Phase Continuous Frequency Sweep is desired but Stepped Frequency Sweep is on, one of the start or stop frequencies must be turned off (using a procedure from "How to Stop the Sweep" below) before Phase Continuous Frequency Sweep (Special Function 123) can be selected.

START FREQ, STOP FREQ

How to Set Start and Stop Frequencies

1. Set specific start and stop frequency values:

Start Frequency

START FREQ and the value of the desired sweep start end-point (in GHz, MHz, kHz, or Hz).

Stop Frequency

STOP FREQ and the value of the desired sweep stop end-point (in GHz, MHz, kHz, or Hz).

2. You can also set last-selected start and/or stop frequency values by selecting **START FREQ OFF ON** and/or **STOP FREQ OFF ON** (HP-IB codes: FAON and FBON).

How to Stop the Sweep

1. You can stop the sweep by turning off both the start and stop end-point settings:

START FREQ OFF ON STOP FREQ OFF ON (HP-IB codes: FAOF FBOF)

When sweep is stopped, the output frequency setting is equal to the end-point value that was turned off last. (We recommend you exit frequency sweep this way to prevent Parameter Changed messages discussed on page 3-182)

2. You can also stop the sweep by turning off just one of the end-point settings (when both end-points are set), for example:

START FREQ OFF ON (HP-IB code: FAOF)

When sweep is stopped, the output frequency setting is equal to the remaining displayed end-point value (the value of the stop frequency). We recommend you turn off frequency sweep this way when you want to set a function to occur during a frequency sweep (for example, AM).

RF Frequency Sweep (cont'd)

3. During auto or single sweep (in Stepped Frequency Sweep) you can stop the sweep and display the actual output frequency by selecting manual sweep.

MANUAL (**SHIFT** **STOP FREQ**)

Selecting either **FREQ**, **START AMPTD**, or **STOP AMPTD** will also turn off the sweep but may cause a Parameter Changed message. (These messages are discussed on page 3-182.)

AUTO, MANUAL, SINGLE

How to Select a Sweep Mode

Sweep modes available are auto, manual, and single.

START FREQ or **STOP FREQ** must first be selected before one of the frequency sweep modes can be selected.

Auto Sweep

Auto sweep continually repeats the sweep sequence from start frequency to stop frequency:

AUTO (**SHIFT** **START AMPTD**) (HP-IB code: FASA)

The SWPNG annunciator is continuously displayed. (During Stepped Frequency Sweep, the auto sweep can be stopped to display the actual output frequency by selecting manual sweep).

In Stepped Frequency Sweep, auto sweep mode does not allow the following settings:

- Setting start and stop frequency end-points if one end-point is less than 4.130860 MHz (Frequency Band 2) with a second end-point greater than 132.187500 MHz (Frequency Band 6) (For more information about frequency bands, refer to **RF Frequency**, page 3-39.)
- Setting a sweep across 1057.5 MHz (8642B only).
- Setting FM or Φ M.

Manual Sweep

Selecting manual sweep does not start a sweep, but enables the Knob or the Step keys to control a frequency sweep:

MANUAL (**SHIFT** **STOP FREQ**) (HP-IB code: FASM)

Turn the Knob or select the Step keys to sweep between end-points. The actual output frequency as well as the SWPNG annunciator are displayed during the frequency sweep.

HP-IB: You can use the step keys (HP-IB: UP, DN) to sweep in the manual sweep mode since Knob rotation is not possible via HP-IB.

Single Sweep

Selecting single sweep will start or restart a single sweep. Single sweep initiates one sweep only; at the end of the sweep, the output frequency remains at the final end-point value:

SINGLE (**SHIFT** **STOP AMPTD**) (HP-IB code: FASG)

The SWPNG annunciator is displayed for the duration of the single sweep. During Stepped Frequency Sweep, you can stop the sweep and display the actual output frequency by selecting manual sweep

(When operating the instrument locally, a single sweep can also be conveniently restarted by pressing the **OFF/ON** key twice when in the single sweep mode. Start frequency or stop frequency must be the active function in order to use the Off/On function in this way.)

RF Frequency Sweep (cont'd)

TIME

How to Set Sweep Time

Sweep time setting limitations are different for Stepped Frequency Sweep and for Phase Continuous Frequency Sweep.

In all cases, sweep time is set using the following procedure:

TIME (SHIFT START FREQ) and the value of the desired sweep time in s or ms (MHZ V or KHZ MV respectively).

Selecting TIME (SHIFT START FREQ) alone displays the current sweep time setting. If sweep time is not specified, the Signal Generator uses the sweep time value last entered for either amplitude or frequency sweep.

Note that in Stepped Frequency Sweep, a faster sweep time usually results in fewer steps with a larger step size.

For Phase Continuous Frequency Sweep, sweep span and sweep time are coupled together; that is, one may limit the setting of the other. Also, frequency will change in a phase continuous manner but the X-axis output will change in steps.

The following pages contain detailed information about how to understand the relationships between sweep span, sweep time, step size, and number of steps for both Stepped Frequency Sweep and Phase Continuous Frequency Sweep. If you are not interested in these details, you can just adjust sweep time until the approximate desired number of steps or step size is obtained. (To skip these sweep time details, turn to page 3-64.)

The remaining portion of "How to Set Sweep Time" is comprised of two parts.

The first part (which starts on page 3-53) develops some calculations for Stepped Frequency Sweep that will enable you to determine:

- 1) the number of steps automatically selected,
- 2) the frequency step size automatically selected,
- 3) the required sweep time that will select a desired number of frequency steps, and
- 4) the required sweep time that will select a desired step size.

The second part (which starts on page 3-60) develops some calculations for Phase Continuous Frequency Sweep that will enable you to choose frequency span and sweep time so each allows the other's settings. The sweep span limits listed for Phase Continuous Frequency Sweep in Table 3-12 (page 3-49) will not necessarily be possible unless sweep time is set within limits that will allow that sweep span. This same restriction holds true when setting sweep time; that is, the sweep time settings listed in Table 3-16 will not necessarily be possible unless sweep span is set within limits that will allow that sweep time.

The calculations for this second part allow you to determine:

- 1) the minimum sweep span for a desired sweep time and frequency band,
- 2) the maximum sweep span for a desired sweep time and frequency band,
- 3) the minimum sweep time for a desired sweep span and frequency band,
- 4) the maximum sweep time for a desired sweep span and frequency band,
- 5) the number of automatically selected X-axis steps based on a sweep time setting, and
- 6) the required sweep time to select a specific number of X-axis steps.

RF Frequency Sweep (cont'd)

How to Set Sweep Time for Stepped Frequency Sweep (Using Sweep Time to Set Frequency Step Size and Number of Steps)

The operating characteristics for sweep time are as follows:

Minimum Sweep Time	275 ms
Maximum Sweep Time	999s
Sweep Time Resolution	1 ms
Minimum Frequency Sweep Step Size	1 Hz

Minimum Frequency Dwell Time Per Point:

Settling Status	8642A	8642B
Special Function 119 (Disable Settling)	60 ms	80 ms
Special Function 219 (Re-enable Settling)	110 ms	135 ms

Stepped Frequency Sweep Calculations

Since the sweep step size is not directly selectable, the following calculations provide ways to determine:

- 1) the number of steps automatically selected (page 3-53)
- 2) the frequency step size automatically selected (page 3-54)
- 3) the required sweep time that will select a desired number of frequency steps (page 3-54), and
- 4) the required sweep time that will select a desired step size (page 3-57).

However, these calculations do not directly apply to situations when the start end-point is equal to the stop end-point (zero span). Refer to "Zero Span for Stepped Frequency Sweep" on page 3-64 for information about X-axis steps in zero span.

The minimum frequency dwell time per point is different depending on whether you have an 8642A or 8642B and whether you have selected Special Function 119. So, whenever you see the term "Min. Dwell Time" in a calculation, use the table above that lists the Minimum Frequency Dwell Time Per Point to determine the value of that term.

Also, frequency points are truncated to 1 Hz. Span is always an integer since end-points are integers.

1) Calculate the number of steps automatically selected.

The number of steps is the minimum of:

$$1023$$

or

$$|\text{Start Frequency (in Hz)} - \text{Stop Frequency (in Hz)}|$$

or

$$\left[\text{INTEGER OF} \left(\frac{\text{Sweep Time (in ms)}}{\text{Min. Dwell Time (in ms)}} \right) - 1 \right]$$

RF Frequency Sweep (cont'd)

2) Calculate the sweep step size automatically selected.

The result can be a non-integer, but actual frequency points are truncated to 1 Hz (the total number of points is equal to the total number of steps + 1)

The sweep step size is the maximum of:

$$1 \text{ Hz}$$

or

$$\frac{|\text{Start Frequency (in Hz)} - \text{Stop Frequency (in Hz)}|}{1023}$$

or

$$\frac{|\text{Start Frequency (in Hz)} - \text{Stop Frequency (in Hz)}|}{\left[\text{INTEGER OF} \left(\frac{\text{Sweep Time (in ms)}}{\text{Min. Dwell Time (in ms)}} \right) - 1 \right]}$$

3) Calculate a sweep time that could be selected for a desired number of steps.

3a) First you must ensure that the desired number of steps is between the maximum and minimum number of steps possible.

The maximum number of frequency steps is equal to the minimum of:

$$1023$$

or

$$\frac{|\text{Start Frequency (in Hz)} - \text{Stop Frequency (in Hz)}|}{1 \text{ Hz}}$$

The minimum number of frequency steps equals the minimum of:

$$\left[\text{INTEGER OF} \left(\frac{275 \text{ ms}}{\text{Min. Dwell Time (in ms)}} - 1 \right) \right]$$

or

$$\frac{|\text{Start Frequency (in Hz)} - \text{Stop Frequency (in Hz)}|}{1 \text{ Hz}}$$

3b) If the desired number of steps is equal to the maximum, use a sweep time setting (in ms) equal to or greater than the result of the following equation:

$$(\text{Number of Steps} + 1) \times \text{Min. Dwell Time (in ms)}$$

RF Frequency Sweep (cont'd)

If the desired number of steps is less than the maximum calculated in 3a, use a sweep time setting (in ms) greater than or equal to the result of the above calculation but less than the result of the following calculation:

$$(\text{Number of Steps} + 2) \times \text{Min. Dwell Time (in ms)}$$

Example for Calculation #3 (Stepped Frequency Sweep)

In an 8642B, set a stepped frequency sweep from 100 to 500 MHz with 100 frequency steps with Special Function 119 (Disable Settling) selected.

First select Special Function 119:

SPCL (**SHIFT** **-**) **1** **1** **9**

Calculate the required sweep time setting for the 100 frequency steps using calculation #3:

Maximum number of steps is equal to the minimum of 1023 or:

$$\frac{|100\,000\,000\text{ Hz} - 500\,000\,000\text{ Hz}|}{1\text{ Hz}} = 400\,000\,000$$

Since 1023 is less than 400 000 000, the maximum number of steps is 1023.

Minimum number of steps is equal to the minimum of:

$$\left[\text{INTEGER OF} \left(\frac{275}{80} - 1 \right) \right] = 2$$

or

$$\frac{|100\,000\,000\text{ Hz} - 500\,000\,000\text{ Hz}|}{1\text{ Hz}} = 400\,000\,000$$

Since 2 is less than 400 000 000, the minimum value of steps is 2.

Therefore, it should be possible to select 100 steps since that value is between the minimum value (2) and maximum value (1023).

RF Frequency Sweep (cont'd)

Example for Calculation #3 (cont'd)

To get 100 frequency steps, you can set the sweep time between the results of the following calculations:

$$(100 + 1) \times 80 \text{ ms} = 8080 \text{ ms or } 8.080\text{s}$$

$$(100 + 2) \times 80 \text{ ms} = 8160 \text{ ms or } 8.160\text{s}$$

LOCAL (keys)	SWEEP		SWEEP		SWEEP	DATA			
	START FREQ	SHIFT	AUTO START AMPTD	SHIFT	TIME START FREQ	8	.	1	^s MHz V
	SWEEP	DATA			SWEEP	DATA			
	START FREQ	1	0	0	MHz V	STOP FREQ	5	0	0
HP-IB (program codes)	FASA ST 8.1 SC FA 100 MZ FB 500 MZ*								

* These codes are not independent and might need to follow a specific sequence for entry. Refer to the discussion about Sequence Dependency, which begins on page 3-12 in the HP-IB portion of this Section III.

Display

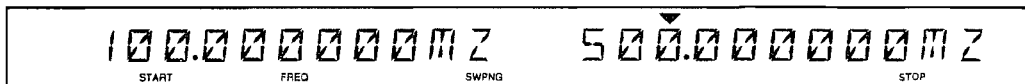

The display usually shows the start frequency and the stop frequency settings. If another active function is selected, the display could indicate frequency sweep with the SWPNG annunciator or by displaying FRQ SWEEPING in the left portion of the display above the FREQ annunciator.

RF Frequency Sweep (cont'd)

4) Calculate a sweep time setting that could be selected for a desired step size.

4a) You need to choose the step size so the frequency span divided by the step size is an integer. You must also ensure that the desired step size is between the maximum and minimum step size possible.

The maximum step size is equal to the maximum of:

$$1 \text{ Hz}$$

or

$$\frac{|\text{Start Frequency (in Hz)} - \text{Stop Frequency (in Hz)}|}{\left[\text{INTEGER OF} \left(\frac{275 \text{ ms}}{\text{Min. Dwell Time (in ms)}} \right) - 1 \right]}$$

The minimum step size is equal to the maximum of:

$$1 \text{ Hz}$$

or

$$\frac{|\text{Start Frequency (in Hz)} - \text{Stop Frequency (in Hz)}|}{1023}$$

4b) When the sweep step size equals the minimum, use a sweep time setting (in ms) equal to or greater than the result of the following calculation.

$$\left[\left(\frac{|\text{Start Frequency (in Hz)} - \text{Stop Frequency (in Hz)}|}{\text{Step Size (in Hz)}} \right) + 1 \right] \times \text{Min. Dwell Time (in ms)}$$

When the sweep step size is greater than the minimum, use a sweep time setting greater than or equal to the result of the above calculation, but less than the result of the following calculation:

$$\left[\left(\frac{|\text{Start Frequency (in Hz)} - \text{Stop Frequency (in Hz)}|}{\text{Step Size (in Hz)}} \right) + 2 \right] \times \text{Min. Dwell Time (in ms)}$$

RF Frequency Sweep (cont'd)

Example for Calculation #4 (Stepped Frequency Sweep)

In an 8642B, set a stepped frequency sweep from 100 to 500 MHz with a sweep step size of 8 MHz with Special Function 219 (Re-Enable Settling).

First select Instrument Preset:

INSTR PRESET

Calculate the required sweep time setting for an 8 MHz step size using calculation #4:

Ensure that an integer results when the frequency span of 400 MHz is divided by the step size of 8 MHz.

$$\frac{400 \text{ MHz}}{8 \text{ MHz}} = 50$$

Maximum step size is equal to the maximum of 1 Hz or:

$$\frac{|100\,000\,000 \text{ Hz} - 500\,000\,000 \text{ Hz}|}{\left[\text{INTEGER OF} \left(\frac{275}{135} - 1 \right) \right]} = 400\,000\,000 \text{ Hz or } 400 \text{ MHz}$$

Since 400 MHz is greater than 1 Hz, the maximum step size is 400 MHz.

Minimum step size is equal to the maximum of 1 Hz or:

$$\frac{|100\,000\,000 \text{ Hz} - 500\,000\,000 \text{ Hz}|}{1023} = 391\,006 \text{ Hz or } 0.391006 \text{ MHz}$$

Since 0.391006 MHz is greater than 1 Hz, the minimum step size is 0.391006 MHz.

Therefore, it should be possible to select an 8 MHz step size since that value is between the minimum value (0.391006 Hz) and maximum value (400 MHz).

RF Frequency Sweep (cont'd)

Example for Calculation #4 (cont'd)

To obtain a step size of 8 MHz, you can set the sweep time between the results of the following calculations:

$$\left[\left(\frac{|100 - 500|}{8} \right) + 1 \right] \times 135 \text{ ms} = 6885 \text{ ms or } 6.885\text{s}$$

$$\left[\left(\frac{|100 - 500|}{8} \right) + 2 \right] \times 135 \text{ ms} = 7020 \text{ ms or } 7.020\text{s}$$

LOCAL (keys)	SWEEP		SWEEP		SWEEP	DATA	
	START FREQ	SHIFT	ALTO START AMPTD	SHIFT	TIME START FREQ	7 MHz V	
	SWEEP	DATA			SWEEP	DATA	
	START FREQ	1	0	0	MHz V	STOP FREQ	5 0 0 MHz V
HP-IB (program codes)	FASA ST 7 SC FA 100 MZ FB 500 MZ*						

* These codes are not independent and might need to follow a specific sequence for entry. Refer to the discussion about Sequence Dependency, which begins on page 3-12 in the HP-IB portion of this Section III.

Display

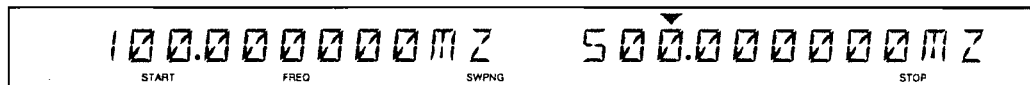

The display usually shows the start frequency and the stop frequency settings. If another active function is selected, the display could indicate frequency sweep with the SWPNG annunciator or by displaying FRQ SWEEPING in the left portion of the display above the FREQ annunciator. To actually see the 8 MHz steps on the display, you can select manual sweep and turn the Knob slowly or use the Step keys.

RF Frequency Sweep (cont'd)

How to Set Sweep Time for Phase Continuous Frequency Sweep (Special Function 123)
 (Understanding Limitations Between Sweep Spans and Sweep Times; Also, How to Set a Specific Number of X-Axis Steps)

The operating characteristics for sweep time are as follows:

Minimum Sweep Time	Refer to calculation #3 on page 3-61
Maximum Sweep Time	Refer to calculation #4 on page 3-61
Sweep Time Resolution	1 ms

Since this type of frequency sweep sweeps in a phase continuous manner, no frequency steps are used (although the X-axis output still uses steps). However, you might want to choose frequency span and sweep time so each allows the other's settings (as described on page 3-52). Also, you can calculate X-axis steps (available at the rear-panel output).

The information that follows will enable you to calculate:

- 1) the minimum sweep span for a desired sweep time and frequency band (page 3-61),
- 2) the maximum sweep span for a desired sweep time and frequency band (page 3-61),
- 3) the minimum sweep time for a desired sweep span and frequency band (page 3-61),
- 4) the maximum sweep time for a desired sweep span and frequency band (page 3-61),
- 5) the number of automatically selected X-axis steps based on a sweep time setting (page 3-62), and
- 6) the required sweep time to select a specific number of X-axis steps (page 3-62)

Since some of the calculations below use the frequency band divide number, the number for each band is listed in the following table.

Band	RF Frequency Range	Divide Number
10	1057.500001 to 2115.000000 (8642B only)	0.5
9	528.750001 to 1057.500000	1
8	264.375001 to 528.750000	2
7	132.187501 to 264.375000	4
6	66.093751 to 132.187500	8
5	33.046876 to 66.093750	16
4	16.523438 to 33.046875	32
3	8.261719 to 16.523437	64
2	4.130860 to 8.261718	128
1	0.100000 to 4.130859	16
Het	0.100000 to 132.187500	1

If the frequency span is not possible from a divide band but would be possible if the Het band was used, the Signal Generator will automatically select the Het band (if Special Function 8, Prefer Heterodyne Band, is not selected). However, if the divide band or the Het band could be used, the Signal Generator will select the divide band. For example, if a sweep setting of 120.0 to 120.4 MHz is selected, the Signal Generator will automatically select the heterodyne band because a 400 kHz span is not possible in Band 6. But if a sweep setting of 120.00 to 120.03 MHz is selected, the Signal Generator will automatically select band 6. (Refer to RF Frequency, page 3-39, for more information about the divide bands and the heterodyne band.)

RF Frequency Sweep (cont'd)

1) Calculate the minimum possible (non-zero) frequency sweep span for a desired sweep time setting.

Minimum non-zero frequency sweep span (in Hz) equals the maximum of:

$$1 \text{ Hz}$$

or

$$\frac{0.2 \text{ Hz per second}}{\text{Divide Number}} \times \text{Sweep Time (in s)}$$

If the result is not an integer, use the next highest integer, for example, if the result is 5.78 Hz, use 6 Hz; if the result is 5.0 Hz, use 5 Hz.

2) Calculate the maximum frequency sweep span for a desired sweep time setting.

Maximum frequency span (in Hz) equals the minimum of:

$$\frac{400\,000 \text{ Hz}}{\text{Divide Number}}$$

or

$$\left[\text{INTEGER OF} \left(\frac{500 \text{ kHz per second}}{\text{Divide Number}} \times \text{Sweep Time (in ms)} \right) \right]$$

3) Calculate the minimum (fastest) sweep time setting for a desired (non-zero) frequency span.

Minimum sweep time (in ms) is equal to the maximum of:

$$5 \text{ ms}$$

or

$$|\text{Start Frequency (in Hz)} - \text{Stop Frequency (in Hz)}| \times \text{Divide Number} \times 0.002 \text{ ms}$$

If the result is not an integer number of ms, use the next highest integer number of ms. For example, if the result is 52.8 ms, use 53 ms; if the result is 52.0 ms, use 52 ms. Another example might be, if the result is 3124.7 ms, use 3.13s (because only 3 digits can be entered for sweep time from the front panel); if the result is 3120 ms, use 3.12s.

4) Calculate the maximum (slowest) sweep time setting for a desired (non-zero) frequency span.

Maximum sweep time (in s) is equal to the minimum of:

$$999\text{s}$$

or

$$|\text{Start Frequency (in Hz)} - \text{Stop Frequency (in Hz)}| \times \text{Divide Number} \times 5\text{s}$$

RF Frequency Sweep (cont'd)

5) Calculate the automatically selected X-axis steps for a desired sweep time setting. Automatically selected number of X-axis steps equals the minimum of:

1023

or

$$\frac{\text{Sweep Time (in ms)}}{1 \text{ ms}}$$

Note: The X-Axis Output changes in steps while frequency changes in a phase continuous manner.

6) Calculate the required sweep time to select a desired number of X-axis steps. The desired number of steps must be less than or equal to 1023. Sweep time (in ms) is equal to:

$$\text{Desired Number of Steps} \times 1 \text{ ms}$$

Note: The X-Axis Output changes in steps while frequency changes in a phase continuous manner.

Example for Calculation #3 (Phase Continuous Frequency Sweep)

Set the instrument to a known state by selecting **INSTR PRESET**.

Set a Phase Continuous Frequency Sweep from 250.2 to 250.3 MHz at the minimum possible sweep time. (This sweep will occur in divide band 7 with divide number 4.)

Minimum sweep time is equal to the maximum of 5 ms or:

$$\text{Minimum Sweep Time} = |250200000 - 250300000| \times 4 \times 0.002 \text{ ms} = 800 \text{ ms}$$

Since 800 ms is greater than 5 ms, 800 ms is the minimum sweep time. Also, since 800 ms is an integer number of ms, this value can be set directly.

RF Frequency Sweep (cont'd)

Example for Phase Continuous Frequency Sweep (cont'd)

LOCAL (keys)		DATA			SWEEP			SWEEP						
	SHIFT	SPCL --	1	2	3	START FREQ	SHIFT	AUTO START AMPTD						
		SWEEP			DATA									
	SHIFT	TIME START FREQ			8	0	0	ms kHz mV						
	SWEEP	DATA			SWEEP	DATA								
	START FREQ	2	5	0	.	2	MHz V	STOP FREQ	2	5	0	.	3	MHz V
HP-IB (program codes)	SP123 FASA ST 800 MS FA 250.2 MZ FB 250.3 MZ*													

* These codes are not independent and might need to follow a specific sequence for entry. Refer to the discussion about Sequence Dependency, which begins on page 3-12 in the HP-IB portion of this Section III.

Display

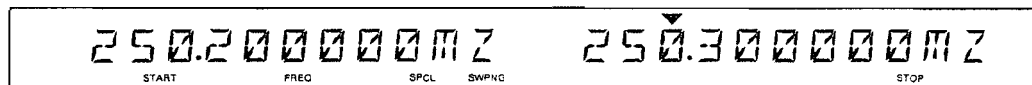

The display usually shows the start frequency and the stop frequency settings. If another active function is selected, the display could indicate frequency sweep with the SWPNG annunciator or by displaying FRQ SWEEPING in the left portion of the display above the FREQ annunciator. The SPCL annunciator is also displayed. To see that Phase Continuous Frequency Sweep has indeed been selected, access the SPCL display (SHIFT -). (Press the SHIFT key twice to return the display to the current instrument settings if desired.)

You can turn off the Phase Continuous Frequency Sweep mode by first stopping the actual sweep (for example with START FREQ OFF ON STOP FREQ OFF ON); HP-IB codes: FAOF and FBOF) and then by selecting Phase Continuous Frequency Sweep Off (Special Function 223).

RF Frequency Sweep (cont'd)

HP-IB Codes

Keys	Codes	Keys	Codes
START FREQ	FA	GHz	GZ
STOP FREQ	FB	MHz	MZ
SWEEP TIME	ST	kHz	KZ
AUTO	FASA	Hz	HZ
MANUAL	FASM	s	SC
SINGLE	FASG	ms	MS
OFF ON	FAOF, FBOF FAON, FBON	SPCL	SP

Comments

Sweep Time Is Common to All Sweeps

Sweep time is common to amplitude sweep and frequency sweep. If sweep time is not specified, the Signal Generator assumes the value last selected for either amplitude or frequency sweep. If this last-selected sweep time value is below the minimum setting allowed under current conditions, the message "SWEEP TIME ADJUSTED .C21" is displayed and sweep time is automatically set to the minimum allowed setting.

Phase Continuous Frequency Sweep, Miscellaneous Information

During Phase Continuous Frequency Sweep (Special Function 123), sweep span and sweep time limitations depend on which frequency band is being used.

The frequency band being used is the center frequency of the sweep, which is one-half of the sum of the start frequency plus the stop frequency. (The start or stop end-point could be outside the band being used).

Changing End-Point Values During the Sweep

During auto or single sweep, the Knob, Step keys, and Data keys can be used to change the start and stop end-points and sweep time values. During manual sweep, the Knob and Step keys can only be used to perform the manual sweep.

HP-IB. How to Manually Sweep

In manual sweep mode, HP-IB codes "UP" and "DN" can be used to step manually by one step (each time the code is sent). Knob rotation is not possible via HP-IB.

How to Tell if the Start and Stop Frequency Entries Are Accepted

If the frequency entries are accepted, both values will appear in the display.

If the frequency entries are not accepted, the displayed message will direct you to the entry error. Sweep span width limitations for Phase Continuous Frequency Sweep (Special Function 123) are listed in Table 3-12, RF Frequency Sweep Operating Characteristics (page 3-49), or explained in "How to Set Sweep Time" that begins on page 3-60. For information about sweep span width limitations for Stepped Frequency Sweep, refer to page 3-51, under "How to Select a Sweep Mode (Auto Sweep)".

Modulation Types Not Possible During Frequency Sweep

During Stepped Frequency Sweep, FM and Φ M are allowed in manual or single sweep mode. During Phase Continuous Sweep (Special Function 123), all modulation types are allowed in all sweep modes. However, the sweep must be stopped to select modulation.

RF Frequency Sweep (cont'd)

DC FM with Phase Continuous Frequency Sweep

During Phase Continuous Frequency Sweep (Special Function 123), dc-coupled FM is not possible when either DC FM Update Mode (Special Function 117) or DC FM Correction (Special Function 216) is selected.

Zero Span for Stepped Frequency Sweep

To calculate the number of X-axis steps automatically selected for zero span using Stepped Frequency Sweep, refer to calculation #1 on page 3-53. To calculate a sweep time that could be selected for a desired number of X-axis steps, refer to calculation #3 on page 3-54. The maximum number of X-axis steps is 1023 (or 1024 points).

Zero Span for Phase Continuous Frequency Sweep (Special Function 123)

To calculate the number of X-axis steps automatically selected for zero span using Phase Continuous Frequency Sweep, refer to calculation #5 on page 3-62.

X AXIS

A 0V to +10V stepped output is available at the X AXIS output connector on the rear panel. The frequency points at the output coincide with the points in the sweep time calculations for Stepped Frequency Sweep. For Phase Continuous Frequency Sweep, frequency changes in a phase continuous manner while the X-axis output changes in steps.

Z AXIS

A blanking pulse is available at the Z AXIS output. (The blanking pulse is TTL positive true for CRT blanking during retrace.)

There is a time that occurs between the end of the sweep and the beginning of the next sweep while the Z AXIS output is blanked and the frequency and X AXIS output are being reset. This time is called start-of-sweep settling time. Start-of-sweep settling time is not included in the sweep time setting. Also, start-of-sweep settling time is not selectable.

For Stepped Frequency Sweep, this settling time is approximately 12% of sweep time with a minimum of 100 ms and a maximum of 600 ms (this time can be reduced by approximately half when you select Special Function 119, Disable Settling).

Normally, for Phase Continuous Frequency Sweep, the settling time is approximately 12% of the sweep time. However, for sweep times less than 75 ms, the settling time can be equal to or slightly greater than the sweep time itself (depending on the sweep span). For sweep times greater than 75 ms, the settling time gradually approaches 12% of the sweep time. Minimum settling time is 15 ms, maximum settling time is 500 ms.

HP-IB. Sequence Dependency

RF frequency sweep settings are sometimes coupled with other functions. Therefore, HP-IB codes may need to be entered in a particular sequence when accessing combinations of these functions. Refer to the discussion about Sequence Dependency, which begins on page 3-12 in the HP-IB portion of this Section III.

RF Frequency Sweep (cont'd)

Related Special Functions

119. Disable Settling. This special function allows the Signal Generator's microprocessor to respond to new commands without waiting for the internal circuitry to settle. When using this special function, it's possible to select a function before the previous function has finished settling. When settling is disabled, response time is improved by up to 40 ms. Special Function 119 disables out-of-lock messages.

219. Re-enable Settling. This special function re-enables the settling that is disabled when Special Function 119 is selected.

121. Sweep Up and Down On. During auto or single sweep modes, the Signal Generator sweeps from the start end-point to the stop end-point and then sweeps from the stop end-point to the start end-point in the same amount of time. See Figure 3-7 below for a comparison of the normal sweep mode (Sweep Up and Down Off; Special Function 221) and the up and down sweep mode (Sweep Up and Down On; Special Function 121). (The waveforms are not drawn to scale). There is no start-of-sweep settling time when this special function is selected. Also, Z AXIS is always a TTL low.

221. Sweep Up and Down Off. This special function re-enables the normal sweep disabled with Special Function 121. Special Function 221 sets the Signal Generator to sweep from the start end-point to the stop end-point, and then again from the start end-point to the stop end-point.

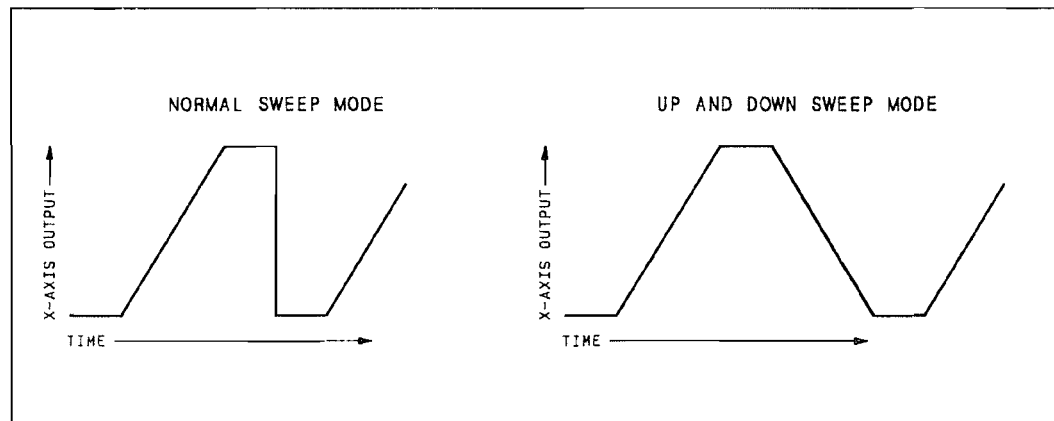

Figure 3-7. Sweep Waveforms

Related Operating Instructions

Refer to **RF Frequency** (page 3-39) for additional information that also applies to RF frequency sweep.

Refer to **Knob** (page 3-141) and **Step, Increment Set** (page 3-149) for information on using these to modify settings.

Refer to **Operating Messages** (page 3-177) if the instrument displays a message you want clarified.

Refer to **Special Functions** (page 3-165) for information about the way these are accessed.

AMPLITUDE CONTENTS

Figure 3-8. Amplitude-Related Functions	3-68	REF SET	3-79
AMPLITUDE	3-69	How to Set a Reference to a Specific Amplitude (in units of dB relative; for example, dBf or dBV)	3-79
Table 3-13. Output Amplitude Operating Characteristics	3-69	How to Reference to the Signal Generator's Last-Selected Reference	3-80
AMPTD	3-70	How to Display the Current Reference	3-80
How to Set the Amplitude Output (with the EMF Mode Off)	3-70	REL OFF	3-81
EMF	3-71	How to Turn Off the Relative Mode	3-81
How to Set the Amplitude Output in EMF Units	3-71	HP-IB Codes	3-81
AMPTD OFF ON, RF OFF/ON	3-72	Comments	3-81
How to Turn Off the Amplitude Output	3-72	AMPLITUDE SWEEP	3-83
Table 3-14. RF.OFF Output Amplitude Levels ..	3-72	Table 3-16. Amplitude Sweep Operating Characteristics	3-83
HP-IB Codes	3-72	How to Turn On Amplitude Sweep	3-83
Comments	3-72	START AMPTD, STOP AMPTD	3-84
Related Special Functions	3-74	How to Set Start and Stop Amplitude Values ..	3-84
4. ALC Off	3-74	How to Stop the Sweep	3-84
9. Attenuator Range Hold On	3-74	AUTO, MANUAL, SINGLE	3-84
119. Disable Settling	3-74	How to Select a Sweep Mode	3-84
Table 3-15. Attenuator Range Hold; Amplitude and AM Ranges	3-75	TIME	3-85
Figure 3-9. Attenuator Range Hold; Amplitude and AM Ranges	3-76	How to Set Sweep Time	3-85
RELATIVE AMPLITUDE	3-77	How to Set Sweep Time (Using Sweep Time to Set Amplitude Step Size and Number of Steps)	3-86
REL ZERO	3-77	HP-IB Codes	3-92
How to Set the Current Output Amplitude Setting to Be the Amplitude Reference	3-77	Comments	3-92
REF SET	3-78	Related Special Functions	3-93
How to Set a Reference to a Specific Amplitude (in units of dBm, V, mV, μ V, EMF V, EMF mV, or EMF μ V)	3-78	121. Sweep Up and Down On	3-93
		Figure 3-10. Sweep Waveforms	3-93
		122. Linear Amplitude Sweep	3-94

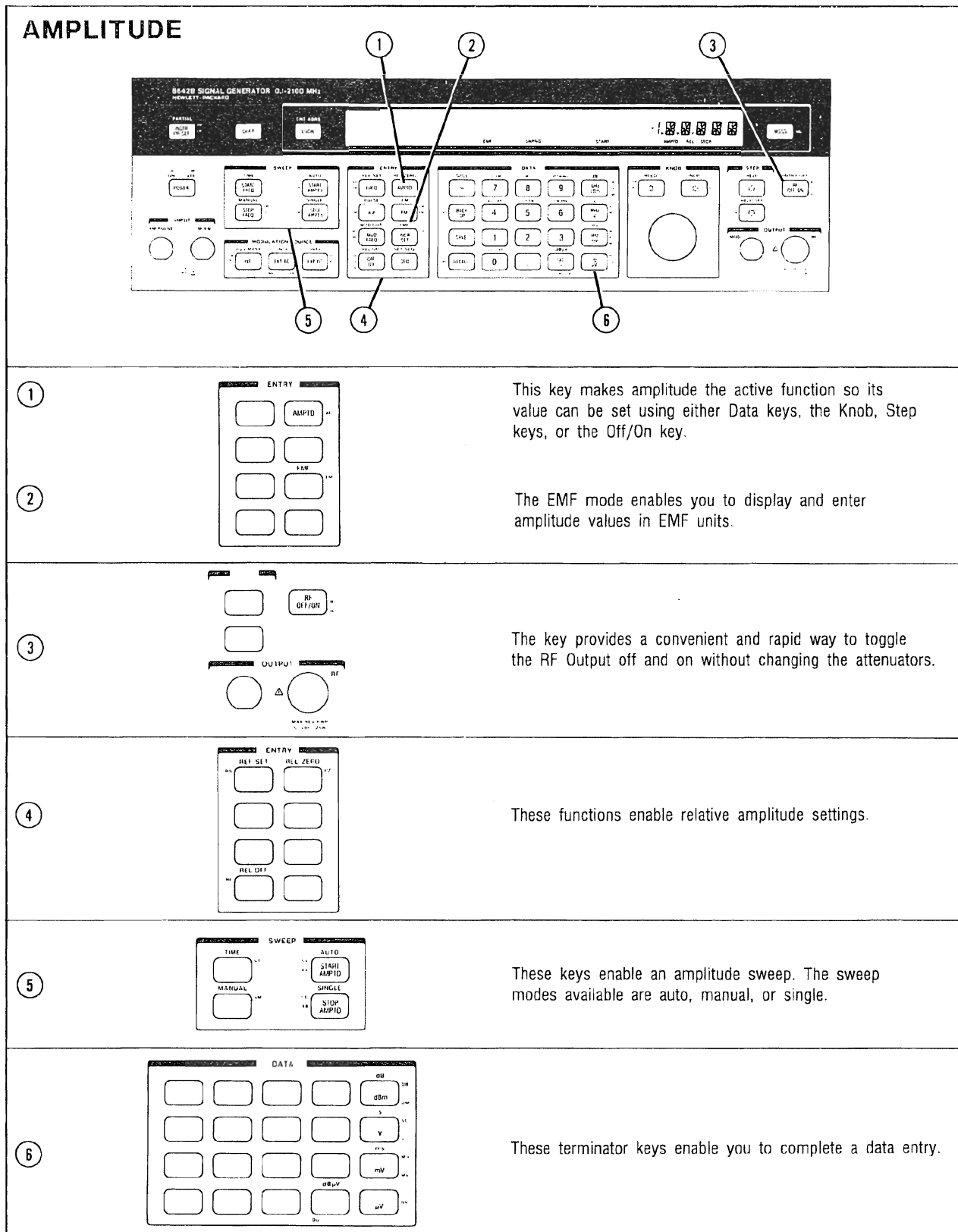

Figure 3-8. Amplitude-Related Functions

AMPLITUDE

Description Output amplitude can be entered directly in units of: dBm, V, mV, uV, and dBuV. EMF amplitude units can also be directly entered in units of: EMF V, EMF mV, EMF uV, and dB EMF uV. The Attenuator Range Hold function (Special Function 9) enables the Signal Generator to produce a 30 dB amplitude range with monotonic, step-to-step amplitude increments. The RF output can be turned off using two different methods. One method turns off the output without adjusting the Signal Generator's output attenuators. The other method reduces the output below the lowest possible amplitude setting using the output attenuator and the automatic leveling control circuit.

Table 3-13. Output Amplitude Operating Characteristics

Electrical Characteristics	Performance Limits	Conditions
Ranges	+20.0 to -140.0 dBm (2.24V to 0.023 μ V) (4.49 EMF V to 0.046 EMF μ V) (+127.0 to -33.0 dB μ V) (+133.0 to -27.0 dB EMF μ V) +19.0 to -140.0 dBm (2.00V to 0.023 μ V) (4.01 EMF V to 0.046 EMF μ V) (+126.0 to -33.0 dB μ V) (+132.0 to -27.0 dB EMF μ V) +18.0 to -140.0 dBm (1.78V to 0.023 μ V) (3.56 EMF V to 0.046 EMF μ V) (+125.0 to -33.0 dB μ V) (+131.0 to -27.0 dB EMF μ V) +17.0 to -140 dBm (1.59V to 0.023 μ V) (3.19 EMF V to 0.046 EMF μ V) (+124.0 to -33.0 dB μ V) (+130.0 to -27.0 dB EMF μ V) +16.0 to -140.0 dBm (1.41V to 0.023 μ V) (2.83 EMF V to 0.046 EMF μ V) (+123.0 to -33.0 dB μ V) (+129.0 to -27.0 dB EMF μ V)	For the 8642A and 8642B: RF Frequencies of 0.100000 to 264.375000 MHz (except Heterodyne Band) For the 8642A: Not applicable For the 8642B: RF Frequencies of 264.375001 to 528.750000 MHz. For the 8642A: RF Frequencies of 264.375001 to 528.750000 MHz as well as Heterodyne Band RF Frequencies of 0.100000 to 132.187500 MHz For the 8642B: The above Heterodyne Band RF Frequencies For the 8642A: Not applicable For the 8642B: RF Frequencies of 528.750001 to 1057.500000 MHz For the 8642A: RF Frequencies of 528.750001 to 1057.500000 MHz For the 8642B: RF Frequencies of 1057.500001 to 2115.000000 MHz
Resolution	0.1 dB	
Absolute Level Accuracy ¹	\pm 1 dB \pm 3 dB	Output Amplitude \geq -127 dBm into a 50 Ω load Output Amplitude $<$ -127 dBm into a 50 Ω load From receipt of controller command
Output Level Switching Time	<100 ms	
Output Impedance	50 ohms	
Flatness	< \pm 0.75 dB	Output level, +10 dBm
SWR	<1.5:1 <2.0:1	Output levels <0 dBm Output levels \geq 0 dBm
Reverse Power Protection	25W, 50 Vdc	
Third Order Intermodulation	<-55 dBc at +10 dBm. Typically decreases 10 dB for every 5 dB of combined level decrease.	Two signal generators with frequencies spaced 25 kHz apart into a resistive combiner.

¹Absolute level accuracy consists of allowances for detector linearity, temperature, flatness, and attenuator accuracy

Amplitude (cont'd)

Procedures Note: Put the instrument in its initialized state by selecting **INSTR PRESET**.

AMPTD

How to Set the Amplitude Output (with the EMF Mode Off)

You can set the amplitude output by selecting the amplitude function and then setting the desired output level:

AMPTD and the desired output level (in dBm, V, mV, uV, or dBuV; the **RAD %** key is the dBuV terminator).

Example

Set the RF output to -107.3 dBm.

	ENTRY	DATA
LOCAL (keys)	AMPTD	- 1 0 7 . 3 GHz dBm
HP-IB (program codes)	AP -107.3 DM	

Display

100.000000 MHz <small>FREQ</small>	-107.3 DM <small>AMPTD</small>
---------------------------------------	-----------------------------------

Amplitude has been set to -107.3 dBm. The cursor above the amplitude display setting indicates amplitude is the active function.

Example

Set the RF output to 6 dBuV.

	ENTRY	DATA
LOCAL (keys)	AMPTD	6 rad %
HP-IB (program codes)	AP 6 DU	

Display

100.000000 MHz <small>FREQ</small>	6.00 <small>AMPTD REL</small>
---------------------------------------	----------------------------------

Amplitude has been set to 6.0 dBuV. The AMPTD REL annunciators indicate that dBuV is a relative setting. Even though dBuV can be set directly from the front panel, the way this function operates and the way it is displayed are similar to most relative settings. (Refer to **Relative Amplitude**, page 3-77.)

Amplitude (cont'd)

EMF

How to Set the Amplitude Output in EMF Units

The EMF mode is turned on using these selections:

EMF () (HP-IB code: EMON).

Then, the EMF amplitude output can be set by selecting the amplitude function and setting the desired output level:

and the desired output level (in V, mV, uV, or dBuV; the key is the dBuV terminator).

Subsequent voltage entries will be in EMF units (note the EMF annunciator) until the EMF mode is turned off. You can turn off the EMF mode from the front panel in the same way you turned it on:

EMF () (HP-IB code: EMOF).

Example

Turn on the EMF mode.

LOCAL (keys)		ENTRY
	<input type="button" value="SHIFT"/>	<input type="button" value="EMF INCR SET"/> <input type="button" value="OFF ON"/>
HP-IB (program codes)	EMON	

The EMF mode has been activated as indicated by the EMF annunciator. Until this mode is turned off, subsequent amplitude entries will be in EMF units. Now set the amplitude to 2.3 EMF uV.

LOCAL (keys)	ENTRY	DATA
	<input type="button" value="AMPTD"/>	<input type="button" value="2"/> <input type="button" value="."/> <input type="button" value="3"/> <input type="button" value="Hz uV"/>
HP-IB (program codes)	AP 2.3 UV	

Display

100.00000000 MZ <small>FREQ EMF</small>	2.300V <small>AMPTD</small>
---	--------------------------------

Amplitude has been set to 2.3 EMF uV. The cursor above the amplitude display setting indicates amplitude is the active function.

Amplitude (cont'd)

AMPTD OFF ON

RF OFF/ON

How to Turn Off the Amplitude Output

The RF output can be turned off using the following method:

- By selecting the **OFF ON** key when amplitude is the active function (HP-IB: APOF). The amplitude display will read AP.OFF.

When amplitude is turned off in this way, the RF output and all harmonics, subharmonics, and all other spurs will be reduced to a level below -140.0 dBm (0.023 uV, 0.046 EMF uV, -33.0 dBuV, or -27.0 dB EMF uV).

- By selecting **RF OFF/ON**. Amplitude will be toggled off or on each time this key is selected.

Amplitude does not have to be the active function to reduce RF output amplitude with the **RF OFF/ON** key. This function reduces the level of the carrier frequency and associated harmonics without adjusting the output attenuators. (Refer to Table 3-14 below.) The amplitude portion of the display reads RF.OFF.

Table 3-14. RF.OFF Output Amplitude Levels

RF Frequency (MHz)	Output Signal Attenuation (dB)*	Harmonic Attenuation (dB)*
1057.500001 to 2115.000000	≤ -140	≤ -140
528.750001 to 1057.500000	≤ -75	≤ -110
0.100000 to 528.750000 (except Heterodyne Band)	≤ -140	≤ -70
0.100000 to 132.187500 (Heterodyne Band Only)	≤ -75	≤ -110

*dB relative to the carrier signal's original amplitude.

HP-IB Codes

Keys	Codes	Keys	Codes
AMPTD	AP	dBμV	DU
dBm	DM or DB	EMF	EMON, EMOF
V	VL	OFF ON	APOF, APON
mV	MV	RF OFF/ON	R0, R1
μV	UV	SPCL	SP

Comments

Overranging Specified Amplitude

Amplitudes as high as 20 dBm (2.24V, 127.0 dBuV, 4.49 EMF V, or 133.0 dB EMF uV) can be set at any RF frequency setting, but the level is not specified above the values listed in Table 3-13 (on page 3-69).

Amplitude (cont'd)

Depending on combinations of settings selected for amplitude and frequency and/or AM that overrange specified amplitude levels, a message may occur indicating an automatic leveling control (ALC) loop out-of-lock condition. However, the ALC loop out-of-lock condition requires continuous microprocessor action that results in a slight increase in noise, spurious signals, and Radio Frequency Interference (RFI). To eliminate these noise levels, either turn the ALC loop off (Special Function 4) or eliminate the overrange condition. Refer to on page 3-197 for more information about these out-of-lock messages.

Resolution is in dB When Setting Voltage Levels

Select voltage levels with a resolution as small as 0.001 uV (0.002 EMF uV). However, internally the Signal Generator changes the output in units of dBm, with a maximum resolution of 0.1 dB.

Converting Amplitude Units

Refer to Amplitude Units Conversion on page 3-205 for information about changing amplitude values from one unit to another.

Time Required for Output Level Switching

Output level switching time is less than 100 ms from receipt of the last controller command.

Units Used for Increment Set Can Be Different Than Units Used for the Amplitude Setting

An amplitude increment value can be set using a different unit specifier than the unit specifier displayed; for example, the amplitude increment could be in dB with an output setting in volts.

When dBm, V, mV, uV, or dBuV is selected, the Signal Generator allows increment settings in dB, V, mV, or uV.

When EMF V, EMF mV, EMF uV, or dB EMF uV is selected, the Signal Generator allows increment settings in dB, EMF V, EMF mV, or EMF uV.

When the dBm and dBuV Keys Function as dBuV Terminators

Both the dB key () and the dBuV key () function as dBuV terminators when the amplitude is set in dBuV. All other relative amplitude settings use only the dB key as a dB terminator.

HP-IB. Either DB or DM

When selecting units in dBm, either HP-IB code DM or DB can be used. When selecting units in dB relative, either HP-IB code DB or DM can be used. Therefore, amplitude relative must be turned off (APRF) if you want DM to mean dBm.

HP-IB. Sequence Dependency

Amplitude settings are sometimes coupled with Attenuator Range Hold (Special Function 9) or AM settings. Therefore, HP-IB codes may need to be entered in a particular sequence when accessing combinations of these functions. Refer to the discussion about Sequence Dependency which begins on page 3-12 in the HP-IB section of this Section III.

Amplitude (cont'd)

Related Special Functions

4. ALC Off. This special function opens the output leveling loop to provide (typically) a 5 dB improvement in third order intermodulation at a 2 kHz offset. Typical output level accuracy is ± 2 dB when ALC Off is selected.

204. Disable ALC Off. This special function re-enables the output leveling loop that was disabled with Special Function 4.

9. Attenuator Range Hold On. When Attenuator Range Hold is selected, the Signal Generator's output attenuators are fixed and the output ALC loop controls signal amplitude. This produces a 30 dB range with monotonic, step-to-step amplitude increments.

The upper and lower limits of each 30 dB range are determined by the Signal Generator's output amplitude when Attenuator Range Hold is selected. Table 3-15 (on the following page) lists each 30 dB range (in dBm) that is available (depending on the output setting) when Special Function 9 is selected. This table also lists the ranges at which amplitude and AM are specified (which are also dependent on the amplitude setting when Special Function 9 was selected). Figure 3-9 (on page 3-76) is a graphic summary of this table. Refer to Table 1-1 (page 1-7) for AM and output amplitude specifications.

The following functions are not possible when Attenuator Range Hold is enabled: ALC Off (Special Function 4), Pulse Modulation, and Amplitude Sweep.

209. Attenuator Range Hold Off. This special function turns off Attenuator Range Hold that is selected with Special Function 9.

119. Disable Settling. This special function allows the Signal Generator's microprocessor to respond to new commands without waiting for the internal circuitry to settle. When using this special function, it's possible to select a function before the previous function has finished settling. When settling is disabled, response time is improved by up to 40 ms. Special Function 119 disables out-of-lock messages.

219. Re-enable Settling. This special function re-enables the settling that is disabled when Special Function 119 is selected.

Related Operating Instructions

Refer to **Relative Amplitude** (page 3-77) for information on setting amplitude in units other than dBm, V, mV, uV, dBuV, EMF V, EMF mV, EMF uV, or dB EMF uV.

Refer to **Amplitude Sweep** (page 3-83) for information on selecting an amplitude sweep range up to 30 dB.

Refer to **Knob** (page 3-141) and **Step, Increment Set** (page 3-149) for information on using these to modify settings.

Refer to **Instrument Preset, Partial Preset** (page 3-139) for information about setting the instrument to an initialized state that maintains preset references including the selected amplitude units.

Refer to **Operating Messages** (page 3-177) if the instrument displays a message you want clarified.

Refer to **Special Functions** (page 3-165) for information about the way these are accessed.

Amplitude (cont'd)

Table 3-15. Attenuator Range Hold; Amplitude and AM Ranges

Output Amplitude (dBm) When Attenuator Hold is Selected	Available Range of Amplitude (dBm)	Amplitude Range at Which Amplitude is Specified (dBm)	Amplitude Range at Which AM is Specified (dBm)
20.0 to 5.0	20 to -10	15 to 5	10 to 5
4.9 to 0.0	15 to -15	10 to 0	5 to 0
-0.1 to -5.0	10 to -20	5 to -5	0 to -5
-5.1 to -10.0	5 to -25	0 to -10	-5 to -10
-10.1 to -15.0	0 to -30	-5 to -15	-10 to -15
-15.1 to -20.0	-5 to -35	-10 to -20	-15 to -20
-20.1 to -25.0	-10 to -40	-15 to -25	-20 to -25
-25.1 to -30.0	-15 to -45	-20 to -30	-25 to -30
-30.1 to -35.0	-20 to -50	-25 to -35	-30 to -35
-35.1 to -40.0	-25 to -55	-30 to -40	-35 to -40
-40.1 to -45.0	-30 to -60	-35 to -45	-40 to -45
-45.1 to -50.0	-35 to -65	-40 to -50	-45 to -50
-50.1 to -55.0	-40 to -70	-45 to -55	-50 to -55
-55.1 to -60.0	-45 to -75	-50 to -60	-55 to -60
-60.1 to -65.0	-50 to -80	-55 to -65	-60 to -65
-65.1 to -70.0	-55 to -85	-60 to -70	-65 to -70
-70.1 to -75.0	-60 to -90	-65 to -75	-70 to -75
-75.1 to -80.0	-65 to -95	-70 to -80	-75 to -80
-80.1 to -85.0	-70 to -100	-75 to -85	-80 to -85
-85.1 to -90.0	-75 to -105	-80 to -90	-85 to -90
-90.1 to -95.0	-80 to -110	-85 to -95	-90 to -95
-95.1 to -100.0	-85 to -115	-90 to -100	-95 to -100
-100.1 to -105.0	-90 to -120	-95 to -105	-100 to -105
-105.1 to -110.0	-95 to -125	-100 to -110	-105 to -110
-110.1 to -115.0	-100 to -130	-105 to -115	-110 to -115
-115.1 to -120.0	-105 to -135	-110 to -120	-115 to -120
-120.1 to -125.0	-110 to -140	-115 to -125	-120 to -125
-125.1 to -130.0	-115 to -140	-120 to -130	-125 to -130
-130.1 to -135.0	-120 to -140	-125 to -135	-130 to -135
-135.1 to -140.0	-125 to -140	-130 to -140	-135 to -140

Amplitude (cont'd)

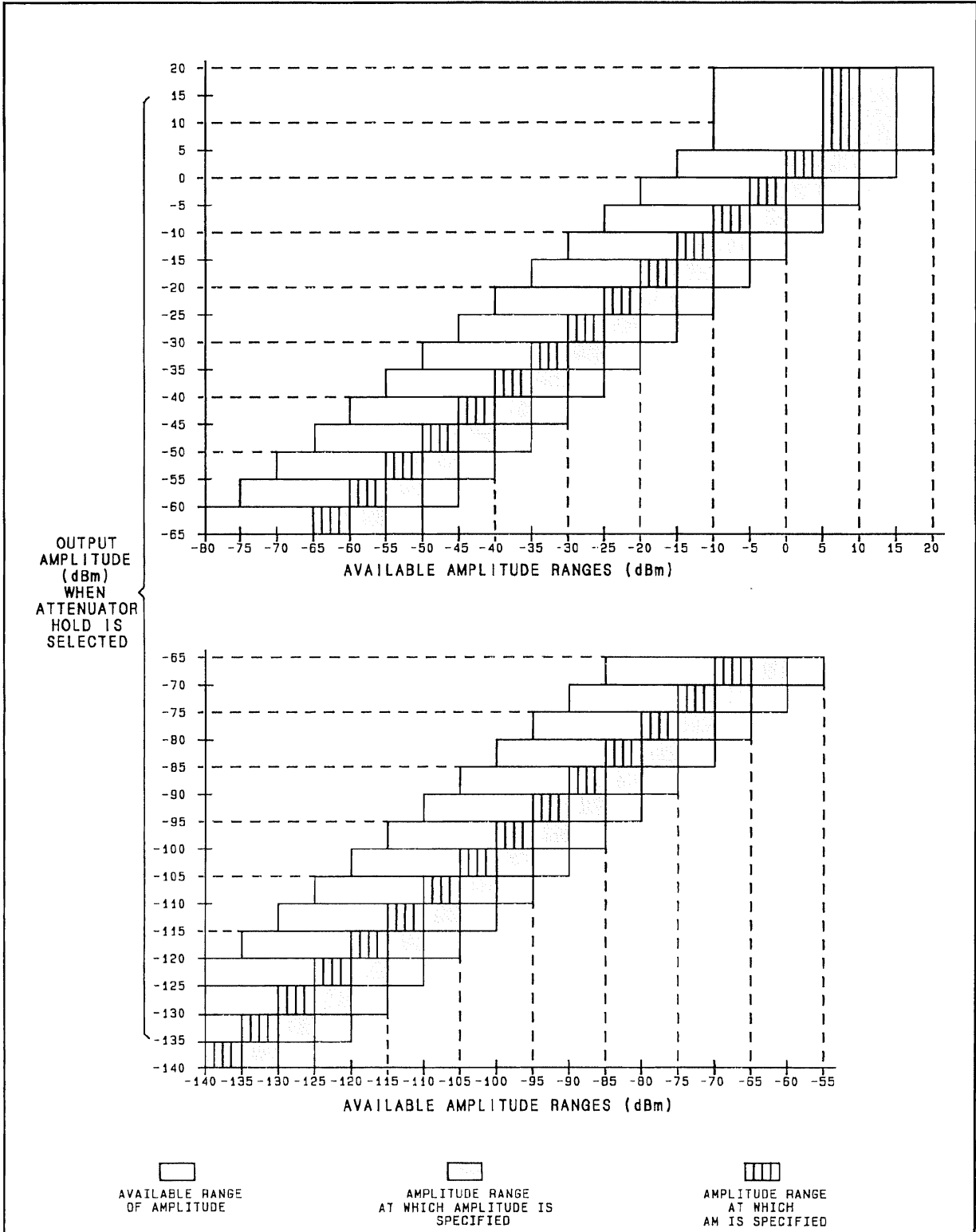

Figure 3-9. Attenuator Range Hold; Amplitude and AM Ranges

RELATIVE AMPLITUDE

Description A dBm amplitude setting is actually a setting relative to a 1 mW reference (even though the 8642A/B treats dBm as an absolute amplitude unit). With the Relative Amplitude mode, the output amplitude can be displayed relative to references other than 1 mW.

The Relative Zero function sets the current amplitude setting to be the amplitude reference. The Reference Set function sets the current display to read as an offset from a specific amplitude reference. Setting a value for Reference Set with the Off/On key causes the amplitude setting to read as an offset from the Signal Generator's last selected reference.

Once an amplitude reference is selected, all subsequent amplitude settings are entered and displayed as relative amplitudes in terms of dB above or below the amplitude reference. This condition exists until the Relative Amplitude mode is turned off.

The actual output amplitude is equal to the sum of the amplitude reference and the displayed amplitude.

Procedures Note: Put the instrument in its initialized state by selecting **INSTR PRESET**.

REL ZERO

How to Set the Current Output Amplitude Setting To Be the Amplitude Reference

Setting the current output amplitude as the amplitude reference causes the amplitude setting display to become 0.0 dB relative.

AMPTD REL ZERO (**SHIFT** **AMPTD**)

Example

Set the amplitude to any arbitrary level using the Knob, Step keys, or Data keys. (For example, you might be setting the level to a reference value that depends on a power level being measured elsewhere on a power meter) Then, "zero" the Signal Generator's amplitude display:

LOCAL (keys)	ENTRY		ENTRY
	AMPTD	SHIFT	REL ZERO AMPTD
HP-IB (program codes)	APRZ		

Relative Amplitude (cont'd)

Display

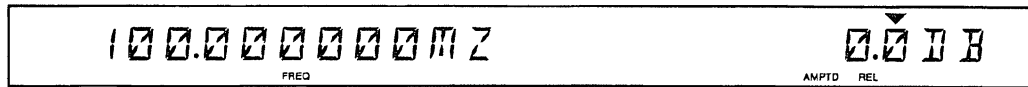

The AMPTD REL annunciators indicate that the amplitude display is a relative output. All subsequent amplitude settings will be entered and displayed in units of dB relative to the absolute amplitude when the Relative Zero function was selected.

After setting the amplitude reference, the dBm key operates as a dB terminator (note the dB printed above the dBm key). For example, after setting the output to read in dB relative units, just key in 20 dB to output 20 dB relative to the absolute amplitude when the Relative Zero function was selected.

REF SET

How to Set a Reference to a Specific Amplitude

(In units of dBm, V, mV, uV, EMF V, EMF mV, or EMF uV.)

Setting a specific RF amplitude as the amplitude reference causes subsequent amplitude settings to display the current output amplitude as dB relative to the amplitude reference.

[AMPTD] REF SET ([SHIFT] [AMPTD]) followed by the value of the desired reference amplitude (in dBm, V, mV, or uV).

REF SET Example 1

Configure the front panel to allow all amplitude setting values to be entered and displayed as offset from a 1V amplitude reference.

First select [INSTR PRESET] to put the instrument in a known state, then:

	ENTRY		ENTRY	DATA
LOCAL (keys)	[AMPTD]	[SHIFT]	[REF SET FREQ]	[1] [MHz V]
HP-IB (program codes)	APRS 1 VL			

Display

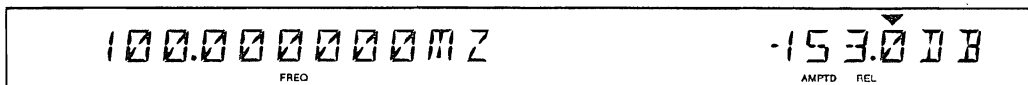

The AMPTD REL annunciators indicate the displayed amplitude is relative to a reference amplitude. The displayed amplitude is -153.0 dB; the actual output amplitude is the displayed amplitude plus the amplitude reference. To convert the amplitude reference to dBm, first exit the relative mode, then select your reference amplitude as the absolute output amplitude (1V in this case), then press the dBm key. The equivalent value for 1V is 13 dBm; therefore, -153 dB + (+13 dBm) = -140 dBm.

Relative Amplitude (cont'd)

REF SET Example 2

Configure the display to read each subsequent amplitude in dBf (that is, dB relative to 1 femtowatt: 0 dBf = -120 dBm).

First select **INSTR PRESET** to put the instrument in a known state, then:

LOCAL (keys)	ENTRY		ENTRY	DATA				
	AMPTD	SHIFT	REF SET FREQ	-	1	2	0	GHz dBm
HP-IB (program codes)	APRS -120 DM							

Display

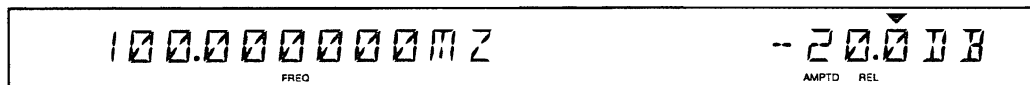

The AMPTD REL annunciators indicate the displayed amplitude is relative to a reference amplitude. The displayed amplitude is -20.0 dB (dBf, in this case). The actual output amplitude is the displayed amplitude plus the amplitude reference; therefore, -20 dB + (-120 dBm) = -140 dBm.

REF SET

How to Set a Reference to a Specific Amplitude
(In units of dB relative; for example, dBf or dBV)

If the output amplitude has already been set to be displayed in relative units (for example, dBf or dBV), use the following procedure to set a specific amplitude reference:

AMPTD followed by the value of the desired reference amplitude (in relative dB units) and **REL ZERO** (**SHIFT** **AMPTD**)

REF SET Example 3

Configure the front panel to display all amplitude output values as an offset from a 20 dBf amplitude reference.

First set the display to read amplitude in dBf using the Relative Zero function as described in "REF SET Example 2" above, then proceed with the following example:

LOCAL (keys)	ENTRY	DATA			ENTRY		ENTRY
	AMPTD	2	0	dB GHz dBm	AMPTD	SHIFT	REL ZERO AMPTD
HP-IB (program codes)	AP 20 DB APRZ						

Relative Amplitude (cont'd)

Display

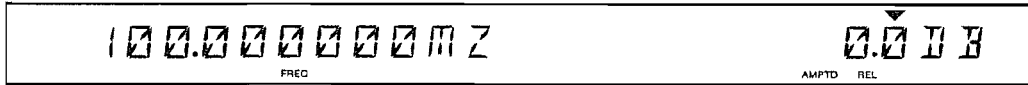

The AMPTD REL annunciators indicate the amplitude display is relative to a reference amplitude. The amplitude is now displayed as 0.0 dB relative to 20 dBf. (Note that the amplitude reference would be displayed as -100 dBm because the reference can only be displayed in absolute units.)

REF SET Example 4

Configure the front panel to display all output amplitude values as an offset from a 12 dBuV amplitude reference. Actual amplitude references in units of dBuV or dB relative cannot be directly set; however, REL ZERO (**SHIFT** **AMPTD**) can be used.

First select **INSTR.PRESET** to put the instrument in a known state, then:

	ENTRY	DATA			ENTRY		ENTRY
LOCAL (keys)	AMPTD	1	2	rad %	AMPTD	SHIFT	REL ZERO AMPTD
HP-IB (program codes)	AP 12 DU APRZ						

Display

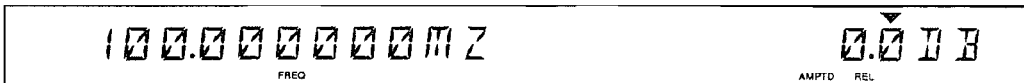

The AMPTD REL annunciators indicate the amplitude display is relative to a reference amplitude. The displayed amplitude is 0.0 dB; the actual amplitude output can be displayed (in dBm) by selecting REF SET (**SHIFT** **FREQ**). The dBm key will function as a dB key when the amplitude setting is relative. (Note that the amplitude reference would be displayed as -95 dBm because the reference can only be displayed in absolute units.)

How to Reference to the Signal Generator's Last-Selected Reference

Turn on the amplitude relative mode by setting the amplitude reference to the last-selected value:

AMPTD REF SET (**SHIFT** **FREQ**) **OFF ON**.

How to Display the Current Reference

AMPTD REF SET (**SHIFT** **FREQ**)

Even though the amplitude reference can be set in dB relative units using the Relative Zero function, the amplitude reference can only be displayed in absolute units. (In this case, the amplitude setting is automatically converted to absolute units before it is set as the amplitude reference.)

Clear the reference display by either pressing the **SHIFT** key twice, or by setting another function.

Relative Amplitude (cont'd)

REL OFF

How to Turn Off the Relative Mode

REL OFF (), or
 REF SET () , or

Select a volts key with amplitude as the active function (volts units are always absolute).

HP-IB

Codes

Keys	Codes	Keys	Codes
REF SET	APRS	dBm	DM or DB
REL ZERO	APRZ	dB	DB or DM
REL OFF	APRF	V	VL
AMPTD	AP	mV	MV
OFF ON	APRSOF, APRSON	μ V	UV
EMF	EMON, EMOF	dB μ V	DU

Comments

Range of Amplitude Reference Settings

Allowable ranges for the amplitude reference settings:

+59.9 dBm to -140 dBm

4.995V to 0.023 μ V

9.99 EMF V to 0.046 EMF μ V

Note that the maximum for the dBm setting is greater than that for the voltage setting. If you want to set a higher voltage reference than 4.995V (9.99 EMF V), convert the value to dBm and set the reference set value as high as +59.9 dBm (221V or 442 EMF V).

Converting Amplitude Units

Refer to Amplitude Units Conversion on page 3-205 for information about changing amplitude values from one unit to another.

When the dBm and dB μ V Keys Function as dB μ V Terminators

Both the dBm key () and the dB μ V key () function as dB μ V terminators when the amplitude is set in dB μ V. All other relative amplitude settings use only the dBm key as a dB terminator.

HP-IB. Either DB or DM

When in the relative amplitude mode, DM does not set dBm; DM and DB set dB relative amplitudes. Therefore, amplitude relative must be turned off (APRF) to have DM mean dBm.

EMF Conversions Are Automatic

Relative settings established in the non-EMF mode will be automatically converted to EMF values when that mode is selected. Similarly, relative settings established in the EMF mode will be converted to non-EMF values when the EMF mode is turned off.

Amplitude Settings Interact With Other Instrument Settings

Some settings are limited by the interaction of coupled functions (for example AM depth and amplitude). Refer to the appropriate Detailed Operating Instruction for setting limitations, and be aware that any restrictions are due to the absolute amplitude, not the relative amplitude setting

Relative Amplitude (cont'd)

Relative Amplitude Sweep

It is not possible to set an amplitude sweep directly in relative units. Refer to page 3-205 for amplitude units conversion information to determine amplitude sweep start and stop end-points in absolute units.

Related Operating Instructions

Refer to **Amplitude** (page 3-69) for additional information about setting amplitude.

Refer to **Knob** (page 3-141) and **Step, Increment Set** (page 3-149) for information on using these to modify settings.

Refer to **Instrument Preset, Partial Preset** (page 3-139) for information on setting the instrument to an initialized state that maintains preset references including the selected amplitude units.

Refer to **Operating Messages** (page 3-177) if the instrument displays a message you want clarified.

AMPLITUDE SWEEP

Description The Signal Generator can amplitude sweep between a start end-point and a stop end-point in linearly spaced, incremental steps.

Sweep step size is automatically selected based on the amplitude span (which is the absolute value of the start amplitude minus the stop amplitude) and the sweep time. Although step size cannot be directly set, this operating instruction provides ways to calculate a sweep time to enable you to select a particular step size or number of steps.

Table 3-16. Amplitude Sweep Operating Characteristics

Electrical Characteristics	Performance Limits	Conditions
Output Amplitude Sweep Range¹	20 dB logarithmic 20 dB linear (with Special Function 122)	
Sweep Time	20 ms minimum 999s maximum	
Accuracy	±1 dB ±3 dB	Over highest 10 dB of amplitude range Over second highest 10 dB of amplitude range
X Axis Output	0 to 10 Vdc	±10%
Z Axis Output	TTL positive true	For crt display blanking during retrace ²
¹ An output amplitude sweep range of 30 dB is possible. However, the lowest 10 dB of amplitude range is not specified. ² Buffer this output in order to use the Z-axis output with a plotter for pen lift.		

Procedures Note: Put the instrument in an initialized state by selecting INSTR PRESET.

How to Turn On Amplitude Sweep

Turn on amplitude sweep by selecting the amplitude sweep mode, the sweep time, and the start and stop amplitude values (procedures for selecting these parameters are described in this instruction). Upon selection of amplitude sweep, the two sweep end-points are displayed as the start amplitude and the stop amplitude. These end-points will be shown as AA.OFF and AB.OFF until sweep values are entered. (AA and AB are the HP-IB codes for start amplitude and stop amplitude, respectively.) Note that if the sweep mode has not been selected since the last time Instrument Preset has been selected, auto sweep is automatically selected and causes the Signal Generator to begin sweeping immediately after end-points are set. (The SWPNG annunciator indicates that a sweep is occurring.)

Amplitude Sweep (cont'd)

START AMPTD, STOP AMPTD

How to Set Start and Stop Amplitude Values

1. Set specific start and stop amplitude values:

Start Amplitude

and the value of the desired sweep start end-point (in dBm, V, mV, or uV). If in the EMF mode, the value can be set in EMF V, EMF mV, or EMF uV.

Stop Amplitude

and the value of the desired sweep stop end-point (in dBm, V, mV, or uV). If in the EMF mode, the value can be set in EMF V, EMF mV, or EMF uV.

2. You can also set last-selected start and/or stop amplitude values by selecting and (HP-IB codes: AAON and ABON).

(To shorten the display of the message "CRUNCH CRUNCH MMMMMMMM I60" you can select either a faster sweep time or Special Function 122, Linear Amplitude Sweep, while you are setting end-point values.)

How to Stop the Sweep

1. You can stop the sweep by turning off both the start and stop end-point settings:

(HP-IB codes: AAOFF ABOF)

When amplitude sweep is stopped, output levels are reduced to the levels described in Table 3-14, RF.OFF Output Amplitude Levels (on page 3-72). (We recommend you exit amplitude sweep this way to prevent Parameter Changed messages that are discussed on page 3-182.)

2. You can also stop the sweep by turning off just one of the end-point settings, for example:

(HP-IB code: AAOFF)

When amplitude sweep is stopped, the output amplitude setting is equal to the remaining displayed end-point value. Stopping the sweep using the above example would cause the output amplitude to be equal to the value of the stop amplitude.

3. During auto or single sweep you can stop the sweep and display the actual output amplitude by selecting manual sweep.

MANUAL ()

Selecting either , , PULSE (), , , or will also turn off the sweep but may cause a Parameter Changed message. (These messages are discussed in **Operating Messages**, page 3-182.)

AUTO, MANUAL, SINGLE

How to Select a Sweep Mode

Sweep modes available are auto, manual, and single.

or must first be selected before one of the amplitude sweep modes can be selected.

Amplitude Sweep (cont'd)

Auto Sweep

Auto sweep continually repeats the sweep sequence from start amplitude to stop amplitude:

AUTO () (HP-IB code: AASA)

The SWPNG annunciator is continuously displayed. (The auto sweep can be stopped to display the actual output amplitude by selecting manual sweep)

Manual Sweep

Selecting manual sweep does not start a sweep, but enables the Knob or the Step keys to control an amplitude sweep:

MANUAL () (HP-IB code: AASM)

Turn the Knob or select the Step keys to sweep between end-points. The actual output amplitude as well as the SWPNG annunciator are displayed during the amplitude sweep.

HP-IB: You can use the step keys (HP-IB: UP, DN) to sweep in the manual sweep mode since Knob rotation is not possible via HP-IB.

Single Sweep

Selecting single sweep will start or restart a single sweep (if both end-points are set). Single sweep initiates one sweep only; at the end of the sweep, the output amplitude remains at the final end-point value:

SINGLE () (HP-IB code: AASG)

The SWPNG annunciator is displayed for the duration of the single sweep. (The single sweep can be stopped to display the actual output amplitude by selecting manual sweep).

(When operating the instrument locally, a single sweep can also be conveniently restarted by pressing the key twice when in the single sweep mode. Start amplitude or stop amplitude must be the active function in order to use the Off/On function in this way)

TIME

How to Set Sweep Time

Sweep time is set using the following procedure:

TIME () and the value of the desired sweep time in s or ms (or respectively).

Selecting TIME () alone displays the current sweep time setting. If sweep time is not specified, the Signal Generator uses the sweep time value last entered for either frequency or amplitude sweep.

Note that a faster sweep time usually results in fewer steps with a larger step size.

The following pages contain detailed information about how to understand the relationships between sweep span, sweep time, step size, and number of steps. If you are not interested in these details, you can just adjust sweep time until the approximate desired number of steps or step size is obtained. To skip these sweep time details, turn to page 3-92

Amplitude Sweep (cont'd)

How to Set Sweep Time

(Using Sweep Time to Set Amplitude Step Size and Number of Steps)

The operating characteristics for amplitude sweep time are as follows:

Minimum Sweep Time	20 ms
Maximum Sweep Time	999s
Sweep Time Resolution	1 ms
Minimum Amplitude Sweep Step Size	0.1 dB
Minimum Amplitude Dwell Time per Step	3 ms

Amplitude Sweep Calculations

Since the sweep step size is not directly selectable, the following calculations provide ways to determine:

- 1) the number of steps automatically selected (page 3-86),
- 2) the amplitude step size automatically selected (page 3-87),
- 3) the required sweep time that will select a desired number of amplitude steps (page 3-87), and
- 4) the required sweep time that will select a desired step size (page 3-89).

However, these calculations do not directly apply to situations when the start end-point is equal to the stop end-point (zero span). Refer to "Zero Span for Amplitude Sweep" on page 3-92 for information about X-axis steps in zero span.

These calculations apply only to logarithmic amplitude sweep. Calculations for Linear Amplitude Sweep (Special Function 122) are not discussed because calibration data used during linear sweeps is different for each instrument.

Also, amplitude points are truncated to 0.1 dB. Span is always an integer in 0.1 dB units since end-points are integers in 0.1 dB units.

The start and stop amplitude setting values must be in dBm in order to perform these calculations. (Refer to Amplitude Units Conversion on page 3-205 for information about changing amplitude values to dBm and back to other units.)

1) Calculate the number of steps automatically selected.

The number of steps is the minimum of:

$$\frac{|\text{Start Amplitude (in dBm)} - \text{Stop Amplitude (in dBm)}|}{0.1 \text{ dB}}$$

or

$$\left[\text{INTEGER OF} \left(\frac{\text{Sweep Time (in ms)}}{3 \text{ ms}} \right) - 1 \right]$$

Amplitude Sweep (cont'd)

- 2) Calculate the sweep step size automatically selected.

The result can be a non-integer, but actual amplitude points are truncated to 0.1 dB (the total number of points is equal to the total number of steps + 1).

The sweep step size is the maximum of:

$$0.1 \text{ dB}$$

or

$$\frac{|\text{Start Amplitude (in dBm)} - \text{Stop Amplitude (in dBm)}|}{\left[\text{INTEGER OF} \left(\frac{\text{Sweep Time (in ms)}}{3 \text{ ms}} \right) - 1 \right]}$$

- 3) Calculate a sweep time that could be selected for a desired number of steps.

3a) First you must ensure that the desired number of steps is between the maximum and minimum number of steps possible.

The maximum number of amplitude steps is equal to:

$$\frac{|\text{Start Amplitude (in dBm)} - \text{Stop Amplitude (in dBm)}|}{0.1 \text{ dB}}$$

The minimum number of amplitude steps equals the minimum of:

$$5$$

or

$$\frac{|\text{Start Amplitude (in dBm)} - \text{Stop Amplitude (in dBm)}|}{0.1 \text{ dB}}$$

3b) If the desired number of steps is equal to the maximum, use a sweep time setting (in ms) equal to or greater than the result of the following equation:

$$(\text{Number of Steps} + 1) \times 3 \text{ ms}$$

If the desired number of steps is less than the maximum calculated in 3a, use a sweep time setting (in ms) greater than or equal to the result of the above calculation but less than the result of the following calculation:

$$(\text{Number of Steps} + 2) \times 3 \text{ ms}$$

Amplitude Sweep (cont'd)

Example for Calculation #3

Set an amplitude sweep from -10 dBm to -21 dBm with 100 amplitude steps.

Calculate the required sweep time setting for the 100 amplitude steps using calculation #3:

Maximum number of steps is equal to:

$$\frac{|-10 \text{ dBm} - (-21 \text{ dBm})|}{0.1 \text{ dB}} = 110$$

Minimum number of steps is equal to a minimum of:

5

or

$$\frac{|-10 \text{ dBm} - (-21 \text{ dBm})|}{0.1 \text{ dB}} = 110$$

Since 5 is less than 110, the minimum number of steps is 5.

Therefore, it should be possible to select 100 steps since that value is between the minimum value (5) and maximum value (110).

To get 100 amplitude steps, you can set the sweep time between the results of the following calculations.

$$(100 + 1) \times 3 \text{ ms} = 303 \text{ ms}$$

$$(100 + 2) \times 3 \text{ ms} = 306 \text{ ms}$$

	SWEEP		SWEEP		SWEEP	DATA			
LOCAL (keys)	<input type="button" value="START
AMPTD"/>	<input type="button" value="SHIFT"/>	<input type="button" value="AUTO
START
AMPTD"/>	<input type="button" value="SHIFT"/>	<input type="button" value="TIME
START
FREQ"/>	<input type="text" value="3"/> <input type="text" value="0"/> <input type="text" value="4"/> <input type="text" value="ms
kHz
mV"/>			
	SWEEP	DATA			SWEEP	DATA			
	<input type="button" value="START
AMPTD"/>	<input type="text" value="-"/>	<input type="text" value="1"/>	<input type="text" value="0"/>	<input type="text" value="GHz
dBm"/>	<input type="button" value="STOP
AMPTD"/>	<input type="text" value="-"/>	<input type="text" value="2"/>	<input type="text" value="1"/>
 (program codes)	AASA ST 304 MS AA -10 DM AB -21 DM								

Amplitude Sweep (cont'd)

Example for Calculation #3 (cont'd)

Display

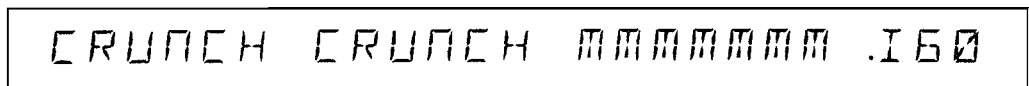

The display shows that the amplitude values are possible and are currently being set.

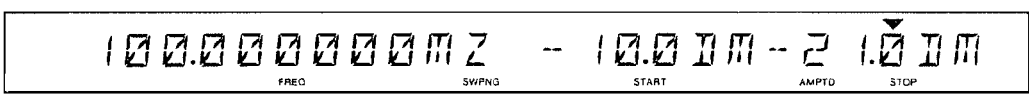

The display usually shows the start amplitude and the stop amplitude settings. If another active function is selected, the display could indicate amplitude sweep with the SWPNG annunciator or by displaying SWEEP in the right portion of the display above the AMPTD annunciator.

4) Calculate a sweep time setting that could be selected for a desired step size.

4a) You need to choose the step size so the amplitude span divided by the step size is an integer. You must also ensure that the desired step size is between the maximum and minimum step size possible.

The maximum step size is equal to the maximum of:

$$0.1 \text{ dB}$$

or

$$\frac{|\text{Start Amplitude (in dBm)} - \text{Stop Amplitude (in dBm)}|}{5}$$

The minimum step size is equal to 0.1 dB

4b) When the sweep step size equals the minimum, use a sweep time setting (in ms) equal to or greater than the result of the following calculation.

$$\left[\left(\frac{|\text{Start Amplitude (in dBm)} - \text{Stop Amplitude (in dBm)}|}{\text{Step Size (in dB)}} \right) + 1 \right] \times 3 \text{ ms}$$

When the sweep step size is greater than the minimum, use a sweep time setting greater than or equal to the result of the above calculation, but less than the result of the following calculation:

$$\left[\left(\frac{|\text{Start Amplitude (in dBm)} - \text{Stop Amplitude (in dBm)}|}{\text{Step Size (in dB)}} \right) + 2 \right] \times 3 \text{ ms}$$

Amplitude Sweep (cont'd)

Example for Calculation #4

Set an amplitude sweep from -10 to +10 dBm with a sweep step size of 0.8 dB.

Calculate the required sweep time setting for a 0.8 dB step size using calculation #4:

Ensure that an integer results when the amplitude span (of 20 dB) is divided by the step size of 0.8 dB

$$\frac{20 \text{ dB}}{0.8 \text{ dB}} = 25$$

Minimum step size is equal to 0.1 dB.

Maximum step size is equal to the maximum of:

$$0.1 \text{ dB}$$

or

$$\frac{|-10 \text{ dBm} - 10 \text{ dBm}|}{5} = 4 \text{ dB}$$

Since 4 dB is greater than 0.1 dB, the maximum step size is 4 dB.

Therefore, it should be possible to select a 0.8 dB step size since that value is between the minimum value (0.1 dB) and maximum value (4 dB).

To obtain a step size of 0.8 dB, you can set the sweep time between the results of the following calculations:

$$\left[\left(\frac{|-10 \text{ dBm} - 10 \text{ dBm}|}{0.8 \text{ dB}} \right) + 1 \right] \times 3 \text{ ms} = 78 \text{ ms}$$

$$\left[\left(\frac{|-10 \text{ dBm} - 10 \text{ dBm}|}{0.8 \text{ dB}} \right) + 2 \right] \times 3 \text{ ms} = 81 \text{ ms}$$

LOCAL (keys)	SWEEP		SWEEP		SWEEP	DATA
	START AMP/D	SHIFT	AUTO START AMP/D	SHIFT	TIME START FREQ	8 0 <small>ms</small> MHz mV
	SWEEP	DATA			SWEEP	DATA
	START AMP/D	-	1	0	GHz dBm	STOP AMP/D
HP-IB (program codes)	AASA ST 80 MS AA -10 DM AB 10 DM					

Amplitude Sweep (cont'd)

Example for Calculation #4 (cont'd)

Display

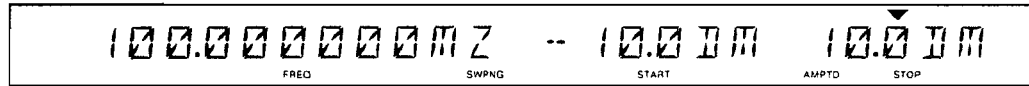

The display usually shows the start amplitude and the stop amplitude settings. If another active function is selected, the display could indicate amplitude sweep with the SWPNG annunciator or by displaying SWEEP in the right portion of the display above the AMPTD annunciator. To actually see the 0.8 dB steps on the display, you can select manual sweep and turn the Knob slowly or use the Step keys.

Amplitude Sweep (cont'd)

HP-IB Codes

Keys	Codes
START AMPTD	AA
STOP AMPTD	AB
SWEEP TIME	ST
AUTO	AASA
MANUAL	AASM
SINGLE	AASG
OFF ON	AAOF, ABOF AAON, ABON

Keys	Codes
dBm	DM or DB
V	VL
mV	MV
μ V	UV
s	SC
ms	MS
EMF	EMON, EMOF
SPCL	SP

Comments

Sweep Time Is Common to All Sweeps

Sweep time is common to amplitude sweep and frequency sweep. If sweep time is not specified, the Signal Generator assumes the value last selected for either amplitude or frequency sweep. If this last-selected sweep time value is below the minimum setting allowed under current conditions, the message "SWEEP TIME ADJUSTED .C21" is displayed and sweep time is automatically set to the minimum allowed setting.

Changing End-Point Values During the Sweep

During auto or single sweep, the Knob, Step keys, and Data keys can be used to change the start and stop end-points and sweep time values. During manual sweep, the Knob and Step keys can only be used to perform the manual sweep.

HP-IB. How to Manually Sweep

In the manual sweep mode, HP-IB codes "UP" and "DN" can be used to step manually by one step (each time the code is sent). Knob rotation is not possible via HP-IB.

How to Tell if the Start and Stop Amplitude Entries Are Accepted

If the amplitude values entered are accepted, both values will appear in the display.

If the amplitude values entered are not accepted, a message will either be queued up or displayed to direct you to the entry error.

Modulation Types Not Possible During Amplitude Sweep

AM and pulse modulation are not possible during amplitude sweep.

Limitations on Display Resolution When Manually Sweeping in Volts Units

During manual sweep, when the end-points are set in volts, it may seem like the Signal Generator is not reaching the selected end-points. Also, when Linear Amplitude Sweep (Special Function 122) is selected with a sweep set in volts, the display may seem to change more coarsely than the actual output is changing. The display operates in these ways because the displayed value is always rounded internally in 0.1 dB units and then converted to volts.

Converting Amplitude Units

Refer to Amplitude Units Conversion on page 3-205 for information about changing amplitude values from one unit to another.

Zero Span for Amplitude Sweep

To calculate the number of X-axis steps automatically selected for zero span, refer to calculation #1 on page 3-86. To calculate a sweep time that could be selected for a desired number of X-axis steps, refer to calculation #3 on page 3-87. The maximum number of X-axis steps is 1023 (or 1024 points).

Amplitude Sweep (cont'd)

Relative Amplitude Sweep

It is not possible to set an amplitude sweep directly in relative units. Refer to page 3-205 for amplitude units conversion information to determine amplitude sweep start and stop end-points in absolute units.

X AXIS

A 0V to +10V stepped output is available at the X AXIS output connector on the rear panel. The amplitude points at the output coincide with the points in the sweep time calculations

Z AXIS

A blanking pulse is available at the Z AXIS output. (The blanking pulse is TTL positive true for CRT blanking during retrace.)

There is a time that occurs between the end of the sweep and the beginning of the next sweep while the Z AXIS output is blanked and the frequency and X AXIS output are being reset. This time is called start-of-sweep settling time. Start-of-sweep settling time is not included in the sweep time setting. Also, start-of-sweep settling time is not selectable.

For amplitude sweep, this settling time is approximately 15% of sweep time with a minimum of 7 ms and a maximum of 500 ms.

Related Special Functions

121. Sweep Up and Down On. During auto or single sweep modes, the Signal Generator sweeps from the start end-point to the stop end-point and then sweeps from the stop end-point to the start end-point in the same amount of time. See Figure 3-10 below for a comparison of the normal sweep mode (Sweep Up and Down Off; Special Function 221) and the up and down sweep mode (Sweep Up and Down On; Special Function 121). (The waveforms are not drawn to scale.) There is no start-of-sweep settling time when this special function is selected. Also, Z-AXIS is always TTL low.

221. Sweep Up and Down Off. This special function re-enables the normal sweep that is disabled with Special Function 121. Special Function 221 sets the Signal Generator to sweep from the start end-point to the stop end-point, and then again from the start end-point to the stop end-point.

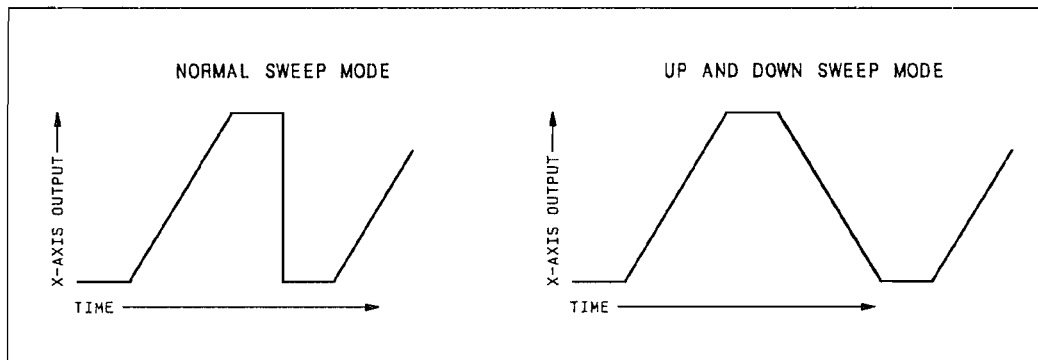

Figure 3-10. Sweep Waveforms

Amplitude Sweep (cont'd)

122. Linear Amplitude Sweep. This special function selects a linearly stepped output rather than the usual logarithmically stepped output. Use a sweep time greater than 900 ms to obtain maximum sweep resolution.

222. Logarithmic Amplitude Sweep. This special function selects the usual logarithmically stepped output disabled with Special Function 122.

Related Operating Instructions

Refer to **Knob** (page 3-141) and **Step, Increment Set** (page 3-149) for information on using these to modify settings.

Refer to **Instrument Preset, Partial Preset** (page 3-139) for information on setting the instrument to an initialized state that maintains preset references including the selected amplitude units.

Refer to **Operating Messages** (page 3-177) if the instrument displays a message you want clarified.

Refer to **Special Functions** (page 3-165) for information about the way these are accessed.

MODULATION CONTENTS

Figure 3-11. Modulation-Related Functions	3-96	MODULATION, Φ M	3-119
MODULATION, AM	3-97	ΦM	3-119
AM	3-97	Table 3-22. Φ M Operating Characteristics	3-119
Table 3-17. AM Operating Characteristics	3-97	Figure 3-15. Φ M Deviation Limitations for each RF Frequency Band	3-119
INT	3-98	INT	3-120
How to Set AM with the Internal Source (Using the Modulation Oscillator)	3-98	How to Set Φ M with the Internal Source (Using the Modulation Oscillator)	3-120
EXT AC, EXT DC	3-98	EXT AC, EXT DC	3-121
How to Set AM with an External Source	3-98	How to Set Φ M with an External Source	3-121
HP-IB Codes	3-100	HP-IB Codes	3-123
Comments	3-101	Comments	3-123
Table 3-18. Limitations on AM Settings With Amplitude	3-102	Related Special Functions	3-124
Related Special Functions	3-104	7. Low Distortion FM/ Φ M On	3-124
113. Modulation Frequency Correction Off	3-104	113. Modulation Frequency Correction Off ..	3-124
248. Calibrate the Modulation Frequency Bands Again	3-104	114. Negative Φ M Polarity	3-124
MODULATION, FM	3-105	119. Disable Settling	3-125
FM	3-105	248. Calibrate the Modulation Frequency Bands Again	3-125
Table 3-19. FM Operating Characteristics	3-105	MODULATION, PULSE	3-127
Figure 3-12. FM Deviation Limitations for each RF Frequency Band; Modulation Frequencies <1389 Hz	3-106	PULSE	3-127
Figure 3-13. FM Deviation Limitations for each RF Frequency Band; Modulation Frequencies \geq 1389 Hz	3-106	Table 3-23. Pulse Modulation Operating Characteristics	3-127
INT	3-107	INT	3-127
How to Set FM with the Internal Source (Using the Modulation Oscillator)	3-107	How to Set Pulse Modulation with the Internal Source	3-127
EXT AC, EXT DC	3-108	EXT AC, EXT DC	3-128
How to Set FM with an External Source	3-108	How to Set Pulse Modulation with an External Source	3-128
HP-IB Codes	3-110	HP-IB Codes	3-129
Comments	3-110	Comments	3-129
Table 3-20. Maximum FM Deviation Settings with Only an External Source	3-112	Related Special Functions	3-130
Related Special Functions	3-112	113. Modulation Frequency Correction Off ..	3-130
5. External Low Rate FM On	3-112	248. Calibrate the Modulation Frequency Bands Again	3-130
112. Internal + External Low Rate FM On ..	3-112	MODULATION OSCILLATOR	3-131
6. FM Pre-emphasis On	3-113	Table 3-24. Modulation Oscillator Operating Characteristics	3-131
Figure 3-14. FM Deviation Limits with/ without FM Pre-Emphasis	3-114	MOD FREQ	3-131
Table 3-21. Factor for Y-Axis FM Deviation Quotient	3-115	How to Set Modulation Frequency	3-131
7. Low Distortion FM/ Φ M On	3-115	MOD OUT	3-131
113. Modulation Frequency Correction Off ..	3-115	How to Set Modulation Output Level	3-131
115. Negative FM Polarity	3-115	HP-IB Codes	3-132
116. DC FM Correction Off	3-116	Comments	3-132
117. DC FM Update Mode On	3-116	Related Special Functions	3-133
118. AC-Coupled DC FM On	3-116	113. Modulation Frequency Correction Off ..	3-133
119. Disable Settling	3-116	248. Calibrate the Modulation Frequency Bands Again	3-133
248. Calibrate the Modulation Frequency Bands Again	3-116		

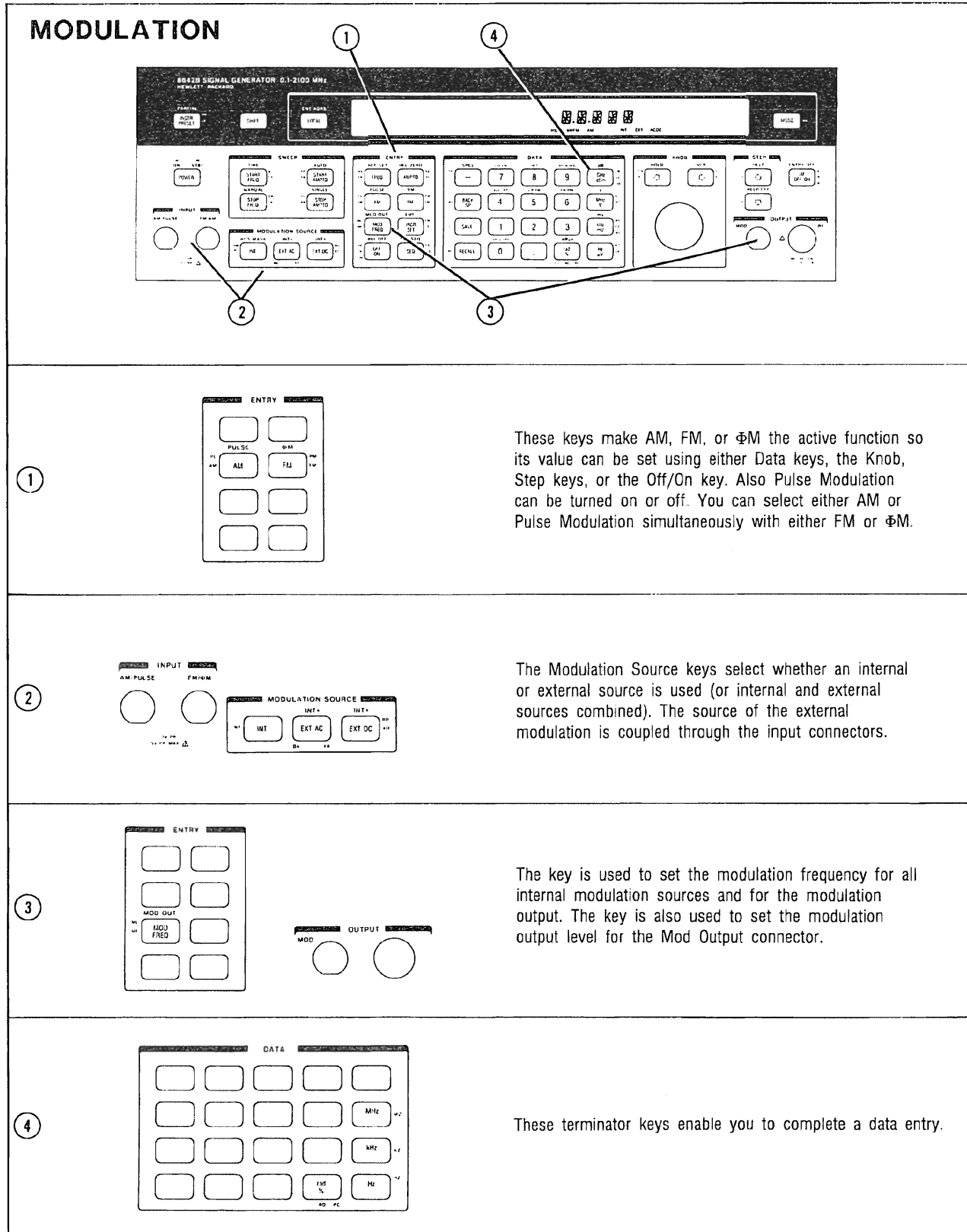

Figure 3-11. Modulation-Related Functions

MODULATION, AM

Description

The Signal Generator can amplitude modulate its RF output either with a variable internal modulation oscillator and/or with an ac- or dc-coupled external source applied to the AM/PULSE INPUT.

When amplitude settings exceed +14.0 dBm (1.12V, 121.0 dBuV, 2.25 EMF V, and 127.0 dB EMF uV), the AM depth setting is limited. (Refer to Table 3-18 on page 3-102.)

Table 3-17. AM Operating Characteristics

Electrical Characteristics	Performance Limits	Conditions
AM Depth	0% to 99.9%	Output Amplitude $\leq +10$ dBm ¹ (707 mV, 1.41 EMF V, 117.0 dB μ V, 123 dB EMF μ V)
Resolution	0.1%	
AM Indicator Accuracy (1 kHz rate, up to 90% AM)	$\pm(3.5\%$ of setting +1% AM) $\pm(5\%$ of setting $\pm 1\%$ AM)	8642A bands ³ 1-8, HET; 8642B bands 1-9, HET 8642A band ³ 9, 8642B band 10
AM Distortion at 1 kHz rate	8642A Bands 1-8; 8642B Bands 1-9 <1% <2% <4% 8642A Band 9, HET; 8642B Band 10, HET <2% <4% <6%	0% to 30% AM 30% to 70% AM 70% to 90% AM 0% to 30% AM 30% to 70% AM 70% to 90% AM
AM 3 dB Bandwidth (Depth $\leq 90\%$)	dc to 100 kHz 20 Hz to 100 kHz dc to 20 kHz 20 Hz to 20 kHz	External dc, bands ² 1, 5 thru 10 External ac and internal, bands ³ 1, 5 thru 10 External dc, bands ^{2,3} 2, 3, 4 External ac and internal, bands ^{2,3} 2, 3, 4
Incidental Φ M (1 kHz rate and 30% AM)	<0.2 radians peak	
¹ It is possible to set AM with an output amplitude above this limit. However, its modulation characteristics are not specified. ² Specific band information is available in Table 3-11 ³ AM bandwidths up to 100 kHz can be obtained by selecting Special Function 8 (Prefer Heterodyne Band)		

Procedures

Note: Put the instrument in its initialized state by selecting INSTR PRESET.

AM can be configured to use either the Signal Generator's internal modulation oscillator, an external source, or combinations of the two sources.

Modulation, AM (cont'd)

INT

How to Set AM with the Internal Source (Using the Modulation Oscillator)

Source

AM INT

Rate

and the desired modulation frequency (in kHz or Hz).

Depth

AM and the desired modulation depth (in %).

Example

Amplitude modulate the RF output using the internal modulation oscillator, 80% AM depth, at a 12 kHz rate.

LOCAL (keys)	ENTRY	MODULATION SOURCE	ENTRY	DATA	ENTRY	DATA
	<input type="checkbox"/> AM	<input checked="" type="checkbox"/> INT	<input type="text" value="MOD FREQ"/>	<input type="text" value="1"/> <input type="text" value="2"/> <input type="text" value="kHz mV"/>	<input type="checkbox"/> AM	<input type="text" value="8"/> <input type="text" value="0"/> <input type="text" value="rad %"/>
 (program codes)	AMNT MF 12 KZ AM 80 PC					

Display

MOD.FREQ	12.00KZ	80.0PC	-140.0DM
		AM INT	AMPTD

The RF output is being internally amplitude modulated (as indicated by the AM and INT annunciators). AM depth is 80.0%. Modulation frequency is set to 12.00 kHz. The cursor above the AM setting indicates that AM is the active function.

EXT AC, EXT DC

How to Set AM with an External Source

Source

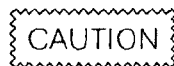

Do not apply more than 15 Vpk maximum external voltage to the AM/PULSE INPUT or damage to the Signal Generator's circuitry could result.

The external modulation source connects to the AM/PULSE INPUT connector (input impedance of 600 ohms).

Modulation, AM (cont'd)

The external modulation signal level should be adjusted to a 1 Vpk (0.707 Vrms) sinewave input to the Signal Generator to get the displayed AM depth. With an external 1 Vpk signal applied, the Signal Generator modulates its RF output to achieve the modulation depth setting. For example, if a 1 Vpk external modulation source is provided, with the Signal Generator's AM depth set to 50.0% per volt, the output has 50.0% modulation depth. (If the source voltage is reduced to 0.5 Vpk, and no other settings are changed, the output has 25% modulation depth.)

If the HI and LO annunciators are not displayed, then the external modulation signal is between 0.95 Vpk and 1.05 Vpk. The HI, LO annunciators only apply to sinewave inputs. The HI, LO detectors do not monitor dc voltage input levels.

External Coupling

Any one of the following functions can be used to couple the external AM/PULSE INPUT to the AM circuitry:

AC-Coupled Source

- **EXT AC**
This function selects the external, ac-coupled AM source (displaying the EXT and AC annunciators).
- INT + (EXT AC) (**SHIFT**, **EXT AC**)
This function selects the external, ac-coupled AM source and internal AM source summed together (displaying the INT, EXT, and AC annunciators).

DC-Coupled Source

- **EXT DC**
This function selects the external, dc-coupled AM source (displaying the EXT and DC annunciators).
- INT + (EXT DC) (**SHIFT**, **EXT DC**)
This function selects the external, dc-coupled AM source and internal AM source summed together (displaying the INT, EXT, and DC annunciators).

Rate

Determined by the external modulation source frequency.

NOTE

External modulation frequency is not monitored by the Signal Generator. The Signal Generator's modulation frequency display refers to the internal modulation oscillator only.

Depth

AM and the desired modulation depth (in % per volt).

The modulation depth setting, when using an external source, sets the input sensitivity per volt, not the actual depth. A linear relationship exists between the AM depth setting and the external voltage applied (for voltages less than or equal to approximately 1.2 Vpk).

Modulation, AM (cont'd)

NOTE

With simultaneous internal and external modulation, the external signals should not cause the AM depth to exceed 99.9%. If this limit is exceeded, the Signal Generator could go out of lock which causes queued up Hardware Error messages. Also, the external AM/PULSE INPUT does not respond linearly to inputs greater than approximately 1.2 Vpk.

Example

Amplitude modulate the RF output with an external, 1 Vpk, dc-coupled source, 80% AM depth, at a rate determined by the external source's frequency.

	ENTRY	MODULATION SOURCE	ENTRY	DATA
LOCAL (keys)	AM	EXT DC	AM	8 0 rad %
HP-IB (program codes)	AMXD AM 80 PC			

Display

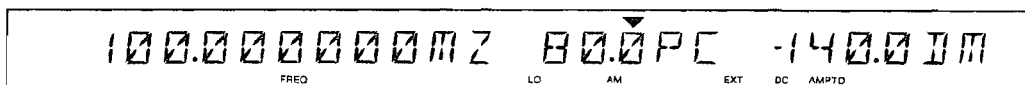

The RF output is being externally amplitude modulated with an external dc-coupled source (as indicated by the AM, EXT, and DC annunciators). AM depth setting is 80.0% per volt. Modulation frequency is not monitored by the Signal Generator when an external modulation source is used. The cursor above the AM setting indicates AM is the active function. The LO annunciator may be indicating that the external modulation source is at a dc level (all inputs appear as "LO") or that there is a sinewave input less than 1 volt.

HP-IB Codes

Keys	Codes
AM	AM
MOD FREQ	MF
INT	AMNT
EXT AC	AMXA
EXT DC	AMXD
INT+ (EXT AC)	AMBA

Keys	Codes
INT+ (EXT DC)	AMBD
OFF ON	AMOF, AMON
%	PC
kHz	KZ
Hz	HZ
SPCL	SP

Modulation, AM (cont'd)

Comments

Specified AM Rates Can Be Increased by Selecting the Het Band

AM depths are specified for depths less than or equal to 90% at a maximum rate of 20 kHz in bands 2, 3, and 4 (4.130860 to 33.046875 MHz). You can increase specified AM rates in this RF frequency range from a maximum of 20 kHz to a maximum of 100 kHz by selecting Special Function 8 (Prefer Het Band). Refer to "How to Select the Het Band" on page 3-41.

Spurious Signals (Spurs) That Occur With the Internal Source

Internally generated spurs (with levels specified less than -100 dBc) might be present when the internal modulation oscillator is in use. These spurs will be eliminated when no internal modulation source is modulating the carrier, and the modulation oscillator (MOD OUT) is off.

Modulation Switching Time

The time required to turn on the internal modulation oscillator or to switch between modulation frequencies can be reduced by approximately 200 ms (depending on modulation frequency), with a loss in modulation frequency accuracy, by selecting Modulation Frequency Correction Off (Special Function 113). For more information, refer to "Speeding Up Modulation Switching Time" on page 3-132.

The time required to turn on the internal modulation oscillator is increased by approximately 200 ms if DC FM Update Mode (Special Function 117) is active. For more information, refer to "117. DC FM Update Mode On" (page 3-116).

Modulation Restrictions with Other Functions

AM and pulse modulation are not possible during amplitude sweep. Also, AM and pulse modulation are not possible when ALC Off (Special Function 4) is selected.

Mixed Modulation

The Signal Generator can simultaneously modulate the RF signal with more than one modulation type. The Signal Generator does not allow simultaneous AM and pulse modulation or simultaneous FM and Φ M. AM is allowed in the following combinations:

Any one of these types:

- Internal AM,
- External ac- or dc-coupled AM, or
- Internal + external ac- or dc-coupled AM

With any one of the following:

- Internal FM,
- External ac- or dc-coupled FM,
- Internal + external ac- or dc-coupled FM,
- External low-rate FM (Special Function 5),
- Internal + external low-rate FM (Special Function 112),
- Internal Φ M,
- External ac- or dc-coupled Φ M, or
- Internal + external ac- or dc-coupled Φ M.

NOTE

All internal modulation sources use the internal modulation oscillator, therefore all internal modulation, as well as MOD OUTPUT, have the same modulation frequency.

Modulation, AM (cont'd)

HP-IB. Sequence Dependency

AM settings are sometimes coupled with Attenuator Range Hold (Special Function 9) or amplitude settings. Therefore, HP-IB codes may need to be entered in a particular sequence when accessing combinations of these functions. Refer to the discussion about Sequence Dependency, which begins on page 3-12 in the HP-IB portion of this Section III.

Maximum Combinations of Amplitude and AM

When amplitude settings exceed +14.0 dBm (1.12V, 121.0 dBuV, 2.25 EMF V, and 127.0 dB EMF uV), the AM depth setting is limited to those settings listed below in Table 3-18.

Table 3-18. Limitations on AM Settings with Amplitude (1 of 2)

Maximum AM Depth (%)	Amplitude				
	dBm	V	dB μ V	EMFV	dB EMF μ V
99.9	-140.0 to 14.0	0.000023 to 1.12	-33.0 to 121.0	0.000046 to 2.25	-27.0 to 127.0
97.2	14.1	1.14	121.1	2.29	127.1
95.0	14.2	1.15	121.2	2.31	127.2
92.8	14.3	1.16	121.3	2.33	127.3
90.5	14.4	1.18	121.4	2.37	127.4
88.4	14.5	1.19	121.5	2.39	127.5
86.2	14.6	1.20	121.6	2.41	127.6
84.1	14.7	1.22	121.7	2.45	127.7
82.0	14.8	1.23	121.8	2.47	127.8
79.9	14.9	1.25	121.9	2.51	127.9
77.8	15.0	1.26	122.0	2.53	128.0
75.8	15.1	1.27	122.1	2.55	128.1
73.8	15.2	1.29	122.2	2.59	128.2
71.8	15.3	1.30	122.3	2.61	128.3
69.8	15.4	1.32	122.4	2.65	128.4
67.9	15.5	1.33	122.5	2.67	128.5
66.0	15.6	1.35	122.6	2.71	128.6
64.1	15.7	1.37	122.7	2.75	128.7
62.2	15.8	1.38	122.8	2.77	128.8
60.3	15.9	1.40	122.9	2.81	128.9
58.5	16.0	1.41	123.0	2.83	129.0
56.7	16.1	1.43	123.1	2.87	129.1
54.9	16.2	1.45	123.2	2.91	129.2
53.1	16.3	1.46	123.3	2.93	129.3

Modulation, AM (cont'd)

Table 3-18. Limitations on AM Settings with Amplitude (2 of 2)

Maximum AM Depth (%)	Amplitude				
	dBm	V	dB μ V	EMFV	dB EMF μ V
51.4	16.4	1.48	123.4	2.97	129.4
49.6	16.5	1.50	123.5	3.01	129.5
47.9	16.6	1.52	123.6	3.05	129.6
46.2	16.7	1.53	123.7	3.07	129.7
44.5	16.8	1.55	123.8	3.11	129.8
42.9	16.9	1.57	123.9	3.15	129.9
41.3	17.0	1.59	124.0	3.19	130.0
39.6	17.1	1.61	124.1	3.23	130.1
38.0	17.2	1.62	124.2	3.25	130.2
36.5	17.3	1.64	124.3	3.29	130.3
34.9	17.4	1.66	124.4	3.33	130.4
33.4	17.5	1.68	124.5	3.37	130.5
31.8	17.6	1.70	124.6	3.41	130.6
30.3	17.7	1.72	124.7	3.45	130.7
28.8	17.8	1.74	124.8	3.49	130.8
27.4	17.9	1.76	124.9	3.53	130.9
25.9	18.0	1.78	125.0	3.57	131.0
24.5	18.1	1.80	125.1	3.61	131.1
23.0	18.2	1.82	125.2	3.65	131.2
21.6	18.3	1.84	125.3	3.69	131.3
20.2	18.4	1.87	125.4	3.75	131.4
18.9	18.5	1.89	125.5	3.79	131.5
17.5	18.6	1.91	125.6	3.83	131.6
16.1	18.7	1.93	125.7	3.87	131.7
14.8	18.8	1.95	125.8	3.91	131.8
13.5	18.9	1.98	125.9	3.97	131.9
12.2	19.0	2.00	126.0	4.01	132.0
10.9	19.1	2.02	126.1	4.05	132.1
9.6	19.2	2.05	126.2	4.11	132.2
8.4	19.3	2.07	126.3	4.15	132.3
7.2	19.4	2.09	126.4	4.19	132.4
5.9	19.5	2.12	126.5	4.25	132.5
4.7	19.6	2.14	126.6	4.29	132.6
3.5	19.7	2.17	126.7	4.35	132.7
2.3	19.8	2.19	126.8	4.39	132.8
1.2	19.9	2.22	126.9	4.45	132.9
0.0	20.0	2.24	127.0	4.49	133.0

Modulation, AM (cont'd)

Related Special Functions

113. Modulation Frequency Correction Off. This special function disables the single-band calibration of the modulation frequency oscillator that normally occurs whenever the modulation oscillator frequency is set or the internal modulation oscillator is put into use. When this calibration is disabled, the typical modulation frequency switching time is decreased by approximately 200 ms. For more information, refer to "Speeding Up Modulation Switching Time" on page 3-132.

213. Modulation Frequency Correction On. This special function re-enables the modulation frequency correction disabled with Special Function 113.

248. Calibrate the Modulation Frequency Bands Again. This special function enables you to initiate the calibration sequence that normally only occurs during instrument power up. This function can be used, for example, to recalibrate the modulation oscillator frequency bands if normal modulation frequency correction has been disabled with Special Function 113. Calibration typically takes one to two seconds.

Related Operating Instructions

Refer to **Modulation Oscillator** (page 3-131) for more information about the internal modulation oscillator that is the common source for all internal modulation as well as for the MOD OUTPUT connector.

Refer to **Amplitude** (page 3-74) for information on Attenuator Range Hold (Special Function 9). This special function creates monotonic amplitude ranges that limit the specified range of AM.

Refer to **Knob** (page 3-141) and **Step, Increment Set** (page 3-149) for information on using these to modify settings.

Refer to **Operating Messages** (page 3-177) if the instrument displays a message you want clarified.

Refer to **Special Functions** (page 3-165) for information about the way these are accessed.

MODULATION, FM

Description The Signal Generator can frequency modulate its RF output either with a variable internal modulation oscillator, and/or with an ac- or dc-coupled external source applied to the FM/ Φ M INPUT.

Depending on the RF frequency selected, the 8642A/B has different limits on the possible FM deviation that can be selected. (See Figures 3-12 and 3-13 on the following page.) The Signal Generator normally selects a divide band to obtain its FM deviation. However, if the divide band's maximum internal FM deviation boundaries are crossed, the Signal Generator can automatically switch to the heterodyne band which allows wider FM deviation at RF frequencies less than 132.187501 MHz. (Refer to **RF Frequency**, page 3-39, for more information about these different bands.) If FM Pre-emphasis is selected, more limitations are placed on FM deviation and modulation frequency. (Refer to the discussion about FM Pre-emphasis starting on page 3-113 under "6. FM Pre-emphasis On".)

Table 3-19. FM Operating Characteristics

Electrical Characteristics	Performance Limits	Conditions
FM Deviation Limitations	See Figures 3-12 and 3-13	
Indicator Accuracy (Rates from 20 Hz to 100 kHz)	\pm (5% of setting +10 Hz)	
Resolution	0.7% of setting or 0.0004% of maximum deviation (whichever is larger)	
FM Distortion (Rates from 20 Hz to 100 kHz)	4% 2% 0.4%	For maximum dc-coupled deviation For $1/2$ maximum dc-coupled deviation For $1/15$ maximum dc-coupled deviation
FM 3 dB Bandwidth	dc to 200 kHz 20 Hz to 200 kHz 20 Hz to 100 kHz 0.4 Hz to 200 kHz (with Special Function 5)	External dc source External ac source Internal source

Modulation, FM (cont'd)

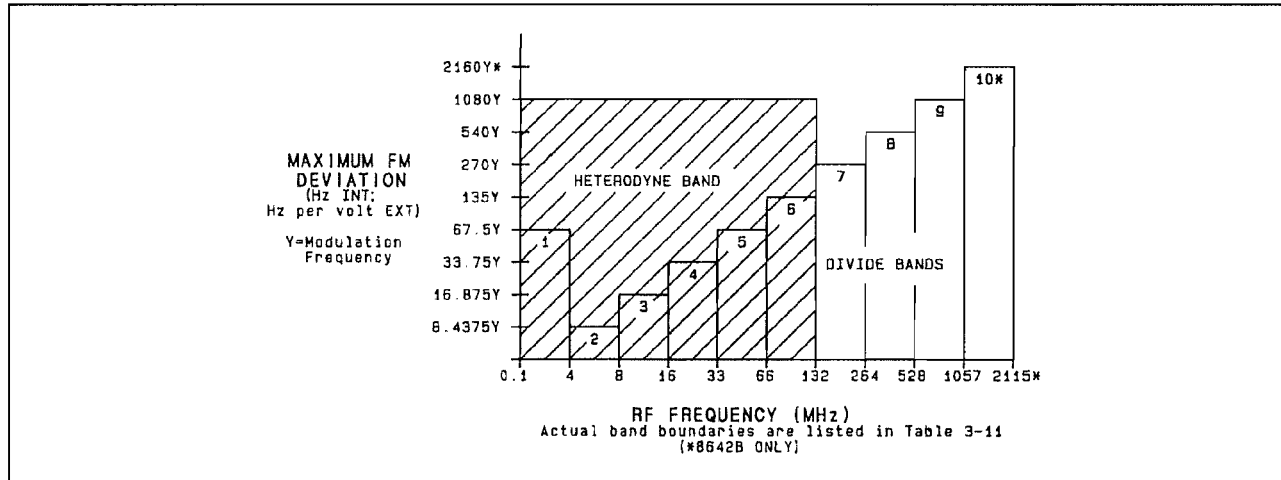

**Figure 3-12. FM Deviation Limitations for each RF Frequency Band;
Modulation Frequencies <1389 Hz**

(Internal, external ac-coupled, or the internal and the external ac-coupled FM source summed together)

Note: The Y in each of the Y-axis values represents the desired modulation frequency value (in Hz). Multiply the numeric value in the Y-axis times the desired modulation frequency value to determine the deviation limits. For example, to determine the maximum possible value of FM deviation for an RF frequency of 500 MHz (the X-axis value) and a desired modulation frequency of 1000 Hz, multiply 540 times 1000. This calculation results in 540 kHz which is the maximum possible FM deviation for these settings.

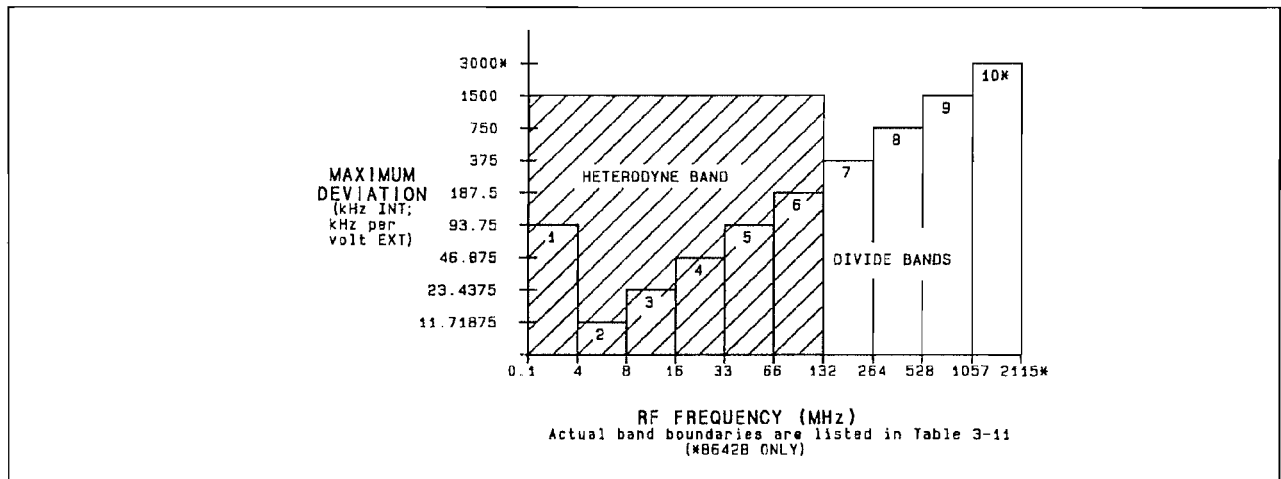

**Figure 3-13. FM Deviation Limitations for each RF Frequency Band;
Modulation Frequencies \geq 1389 Hz**

(Internal, external dc-coupled, or the internal and an external dc-coupled FM source summed together.)

You can determine whether the Signal Generator will select a divide band or the heterodyne band. Assume an RF frequency of 100 MHz. If you select a deviation of 90 kHz, the Signal Generator will use divide band 6 since the maximum possible deviation for band 6 is 187.5 kHz (unless Special Function 8, Prefer Heterodyne Band, is selected). If you select 700 kHz deviation, the Signal Generator will automatically select the heterodyne band. (Note that maximum possible deviation for the heterodyne band is 1500 kHz.)

Modulation, FM (cont'd)

Procedures Note: Put the instrument in its initialized state by selecting **INSTR PRESET**.

FM can be configured to use either the Signal Generator's internal modulation oscillator, an external source, or combinations of the two sources.

INT

How to Set FM with the Internal Source (Using the Modulation Oscillator)

Source

FM **INT**

Rate

MOD FREQ and the desired value of modulation frequency (in kHz or Hz).

Deviation

FM and the desired value of FM deviation (in MHz, kHz, or Hz).

Example

Frequency modulate the RF output using the internal modulation oscillator, at a 12 kHz rate, with 80 kHz FM deviation.

LOCAL (keys)	ENTRY	MODULATION SOURCE	ENTRY	DATA	ENTRY	DATA
	FM	INT	MOD FREQ	1 2 kHz mV	FM	8 0 kHz mV
HP-IB (program codes)	FMNT MF 12 KZ FM 80 KZ*					

* These codes are not independent and might need to follow a specific sequence for entry. Refer to the discussion about Sequence Dependency, which begins on page 3-12 in the HP-IB portion of this Section III.

Display

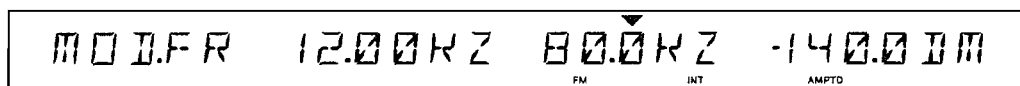

The RF output is being internally frequency modulated (as indicated by the FM and INT annunciators). FM deviation is 80.0 kHz. Modulation frequency is set to 12.00 kHz. The cursor above the FM setting indicates that FM is the active function.

Modulation, FM (cont'd)

How to Set FM with an External Source

EXT AC, EXT DC Source



Do not apply more than 15 Vpk maximum external voltage to the FM/ Φ M INPUT or damage to the Signal Generator's circuitry could result.

The external modulation source connects to the FM/ Φ M INPUT connector (input impedance of 600 ohms).

The external modulation signal level should be adjusted to a 1 Vpk (0.707 Vrms) sinewave input to the Signal Generator to get the displayed FM deviation. With an external 1 Vpk signal applied, the Signal Generator modulates its RF output to achieve the deviation setting. For example, if a 1 Vpk external modulation source is provided, with the Signal Generator's FM deviation set to 50.0 kHz per volt, the output has 50.0 kHz FM deviation. (If the source voltage is reduced to 0.5 Vpk, and no other settings are changed, the output has 25.0 kHz FM deviation.)

If the HI and LO annunciators are not displayed then the external modulation signal is between 0.95 Vpk and 1.05 Vpk. The HI, LO annunciators only apply to sinewave inputs. The HI, LO detectors do not monitor dc voltage input levels.

External Coupling

Any one of the following functions can be used to couple the external FM/ Φ M INPUT to the FM circuitry:

AC-Coupled Source

- **EXT AC**
This function selects the external, ac-coupled FM source (displaying the EXT and AC annunciators).
- **INT + (EXT AC) (SHIFT EXT AC)**
This function selects the external, ac-coupled FM source and internal FM source summed together (displaying the INT, EXT, and AC annunciators).
- **EXTERNAL LOW RATE FM (Special Function 5)**
This function selects the external, ac-coupled FM source for 0.4 Hz to 200 kHz rates (displaying the EXT annunciator).
(Refer to page 3-112 for more information about this special function.)
- **INTERNAL + EXTERNAL LOW RATE FM (Special Function 112)**
This function selects the external, ac-coupled FM source (for 0.4 Hz to 200 kHz rates) and internal FM source summed together (displaying the INT and EXT annunciators). (Refer to page 3-112 for more information about this special function.)
- **AC-COUPLED DC FM**
Note: AC-Coupled DC FM is listed under DC-Coupled Source on page 3-109.

Modulation, FM (cont'd)

DC-Coupled Source

When external dc-coupled FM (DC FM) is selected, the FM reference loop is no longer phase locked. The applied signal is directly coupled to the FM VCO. DC-coupling also minimizes phase shift in the modulating voltage, making dc-coupled FM the preferred coupling path for maximum stereo separation.

- EXT DC
This function selects the external, dc-coupled FM source for dc to 200 kHz rates (displaying the EXT and DC annunciators).
- INT+ (EXT DC) (SHIFT EXT DC)
This function selects the external, dc-coupled FM source and internal FM source summed together (displaying the INT, EXT, and DC annunciators).
- AC-COUPLED DC FM (Special Function 118)
This function causes the external signal to be applied to the unlocked FM VCO allowing maximum stereo separation characteristics (displaying the EXT and DC annunciators). (Refer to page 3-116 for more information about this special function.)

Rate

Determined by the external modulation source frequency.

NOTE

External modulation frequency is not monitored by the Signal Generator. The Signal Generator's modulation frequency display refers to the internal modulation oscillator only.

Deviation

FM and the desired value of FM deviation in MHz, kHz, or Hz (per volt).

When using an external source, the FM deviation setting does not set the actual deviation, it sets the input sensitivity per volt. A linear relationship exists between the FM deviation setting and the external voltage applied (for voltages less than or equal to approximately 1.2 Vpk).

NOTE

With simultaneous internal and external modulation, the sum of the internal and external signals should not cause the FM deviation to exceed the limits mentioned in Figures 3-12 and 3-13 on page 3-106. If these limits are exceeded, the Signal Generator could go out of lock which causes queued up Hardware Error messages. Also, the external FM/ Φ M INPUT does not respond linearly to inputs greater than approximately 1.2 Vpk.

Modulation, FM (cont'd)

Example

Frequency modulate the RF output with an external, 1 Vpk, dc-coupled source, 80 kHz per volt FM deviation, at a rate determined by the external source's frequency.

LOCAL (keys)	ENTRY	MODULATION SOURCE	ENTRY	DATA
	FM	EXT DC	FM	8 0 kHz mV
HP-IB (program codes)	FMXD FM 80 KZ*			

* These codes are not independent and might need to follow a specific sequence for entry. Refer to the discussion about Sequence Dependency, which begins on page 3-12 in the HP-IB portion of this Section III.

Display

100.00000000 MHz	80.0 KZ	-140.0000 m
FREQ	FM	EXT DC AMPTD

The RF output is being externally frequency modulated with an external dc-coupled source (as indicated by the FM, EXT, and DC annunciators). FM deviation setting is 80.0 kHz per volt. Modulation frequency is not monitored by the Signal Generator when an external modulation source is used. The cursor above the FM setting indicates FM is the active function.

HP-IB Codes

Keys	Codes
FM	FM
MOD FREQ	MF
INT	FMNT
EXT AC	FMXA
EXT DC	FMXD
INT+ (EXT AC)	FMBA

Keys	Codes
INT+ (EXT DC)	FMBD
OFF ON	FMOF, FMON
MHz	MZ
kHz	KZ
Hz	HZ
SPCL	SP

Comments

External Modulation

External modulation frequency is not monitored by the Signal Generator. Therefore, if the external FM source violates the maximum deviation relationships shown in Table 3-20 on page 3-112, the Signal Generator will be operating beyond its specified limits and could lose phase lock which causes queued up Hardware Error messages.

Modulation Types Not Possible During RF Frequency Sweep

During Stepped Frequency Sweep, FM and Φ M are allowed in manual or single sweep mode only. During Phase Continuous Frequency Sweep (Special Function 123), all modulation types are possible.

Modulation, FM (cont'd)

Spurious Signals (Spurs) That Occur with the Internal Source

Internally generated spurs (with levels specified less than -100 dBc) might be present when the internal modulation oscillator is in use. These spurs will be eliminated when no internal modulation source is modulating the carrier, and the modulation oscillator output (MOD OUT) is off.

Modulation Switching Time

The time required to turn on the internal modulation oscillator or to switch between modulation frequencies can be reduced by approximately 200 ms (depending on modulation frequency), with a loss in modulation frequency accuracy, by selecting Modulation Frequency Correction Off (Special Function 113). For more information, refer to "Speeding Up Modulation Switching Time" on page 3-132.

The time required to turn on the internal modulation oscillator is increased by approximately 200 ms if DC FM Update Mode (Special Function 117) is active. For more information, refer to "117. DC FM Update Mode On", page 3-116. When switching from a dc-coupled FM source (for example, EXT DC or INT + EXT DC) to a non-dc-coupled FM source, RF frequency can take up to 2 seconds to settle to within 100 Hz of the selected frequency.

Selecting Heterodyne Band Operation

Special Function 8 (Prefer Het Band) can be used to cause the Signal Generator to operate in the heterodyne band, regardless of FM deviation, whenever RF frequency is less than 132.187501 MHz. This function prevents the Signal Generator from switching from the heterodyne band when it would be possible to use the divide bands. Refer to "How to Select the Het Band" on page 3-41.

Mixed Modulation

The Signal Generator can simultaneously modulate the RF signal with more than one modulation type. The Signal Generator does not allow simultaneous AM and pulse modulation or FM and Φ M. FM is allowed in the following combinations:

Any one of these types:

- Internal FM,
- External ac- or dc-coupled FM,
- Internal + external ac- or dc- coupled FM,
- External low rate FM (Special Function 5), or
- Internal + external low rate FM (Special Function 112)

With any one of the following:

- Internal AM,
- External ac- or dc-coupled AM,
- Internal + external ac- or dc-coupled AM,
- Internal pulse modulation, or
- External dc-coupled pulse modulation.

NOTE

All internal modulation sources use the internal modulation oscillator, therefore all internal modulation, as well as MOD OUTPUT, have the same modulation frequency.

Modulation, FM (cont'd)

How to Obtain Low Residual FM

At high FM deviation settings, the residual FM performance of the Signal Generator can be limited by ground loops set up between the external FM source and the Signal Generator. For minimum residual FM, a floating external FM source should be used.

How to Obtain Maximum FM Stereo Separation

Maximum stereo separation (at least 50 dB) is achieved in the heterodyne band with dc-coupled FM. Low Distortion FM (Special Function 7) may be selected to further reduce total harmonic distortion.

HP-IB. Sequence Dependency

FM settings are sometimes coupled with other functions. Therefore, HP-IB codes may need to be entered in a particular sequence when accessing combinations of these functions. Refer to the discussion about Sequence Dependency, which begins on page 3-12 in the HP-IB portion of this Section III.

Table 3-20. Maximum FM Deviation Settings with only an External Source

Band	Frequency Range (MHz)	Maximum FM Deviation Settings (kHz per Volt)	
		Pre-Emphasis Off	Pre-Emphasis On (Special Function 6)
10	1057.500001 to 2115.00000 (8642B only)	3000.000	420.498
9	528.750001 to 1057.500000	1500.000	210.249
8	264.375001 to 528.750000	750.000	105.124
7	132.187501 to 264.375000	375.000	52.562
6	66.093751 to 132.187500	187.500	26.281
5	33.046876 to 66.093750	93.750	13.140
4	16.523438 to 33.046875	46.875	6.570
3	8.261719 to 16.523437	23.437	3.285
2	4.130860 to 8.261718	11.718	1.642
1	0.100000 to 4.130859	93.750	13.140
Het	0.100000 to 132.187500*	1500.000	210.249

*When FM deviations exceed limits listed for Bands 1 through 6, the Signal Generator automatically switches to the Heterodyne Band

Related Special Functions

5. External Low Rate FM On

112. Internal + External Low Rate FM On

These special functions typically provide 0.4 Hz to 200 kHz external-FM ac coupling with the Signal Generator remaining in a phase locked state. Input coupling required for these functions makes the Signal Generator especially sensitive to dc voltage fluctuations. Relatively small dc voltage changes can cause the Signal Generator to lose phase lock, requiring one to two seconds to regain the locked condition. These functions will be turned off when another FM modulation source is selected.

205. External Low Rate FM Off. This special function turns off the FM modulation source selected with Special Function 5. When Special Function 5 is turned off in this way, the Signal Generator selects external, ac-coupled FM.

Modulation, FM (cont'd)

212. Internal + External Low Rate FM Off. This special function turns off the FM modulation source selected with Special Function 112. When Special Function 112 is turned off this way, the Signal Generator selects internal and external, ac-coupled FM summed together.

6. FM Pre-emphasis On. Special Function 6 can be selected to pre-emphasize internal or external FM modulating signals with a 750 us time constant. (Pre-emphasis boosts high frequencies in the modulating signal, prior to modulating the carrier.)

The Signal Generator's FM pre-emphasis creates some restrictions on the allowed combinations of modulation frequency and maximum deviation. See Figure 3-14 on page 3-114 for FM deviation limits that apply when pre-emphasis is selected with the internal modulation source. Table 3-21 (on page 3-115) is to be used in conjunction with Figure 3-14 to calculate the maximum deviation possible. The maximum deviation depends on the RF frequency band and the modulation frequency selected.

See Figure 3-14. The FM deviation is on the Y-axis in the graph. The values of deviation are shown for Band 9 and the heterodyne band only. To calculate the deviation values for the band you are using, use the "Divide Number" column in Table 3-21 and divide that number into the Y-axis deviation value.

For example, the 1.08 MHz FM deviation limit, with a 1 kHz modulation frequency, would be changed to 2.16 MHz for band 10 (divide by 0.5); that same limit for band 8 would be changed to 540 kHz (divide by 2); and for band 7, the limit would be changed to 270 kHz (divide by 4).

The actual calculations used to determine deviation limits with FM pre-emphasis on are as follows (N is the divide number from Table 3-21 on page 3-115, MF is the modulation frequency):

For modulation frequencies greater than or equal to 1389 Hz, the maximum FM deviation is equal to:

$$\frac{(1.5 \times 10^6) (1022)}{N \sqrt{MF^2 + 45030}}$$

For modulation frequencies less than 1389 Hz, the maximum FM deviation is equal to:

$$\frac{(1080 \times MF) (1022)}{N \sqrt{MF^2 + 45030}}$$

Table 3-20 (page 3-112) lists FM deviation limits with an external source.

HP-IB. When using FM pre-emphasis, HP-IB codes may need to be entered in a particular sequence. Refer to the discussion about Sequence Dependency, which begins on page 3-12 in the HP-IB portion of this Section III.

206. FM Pre-emphasis Off. This special function turns off the pre-emphasis that is selected with Special Function 6.

Modulation, FM (cont'd)

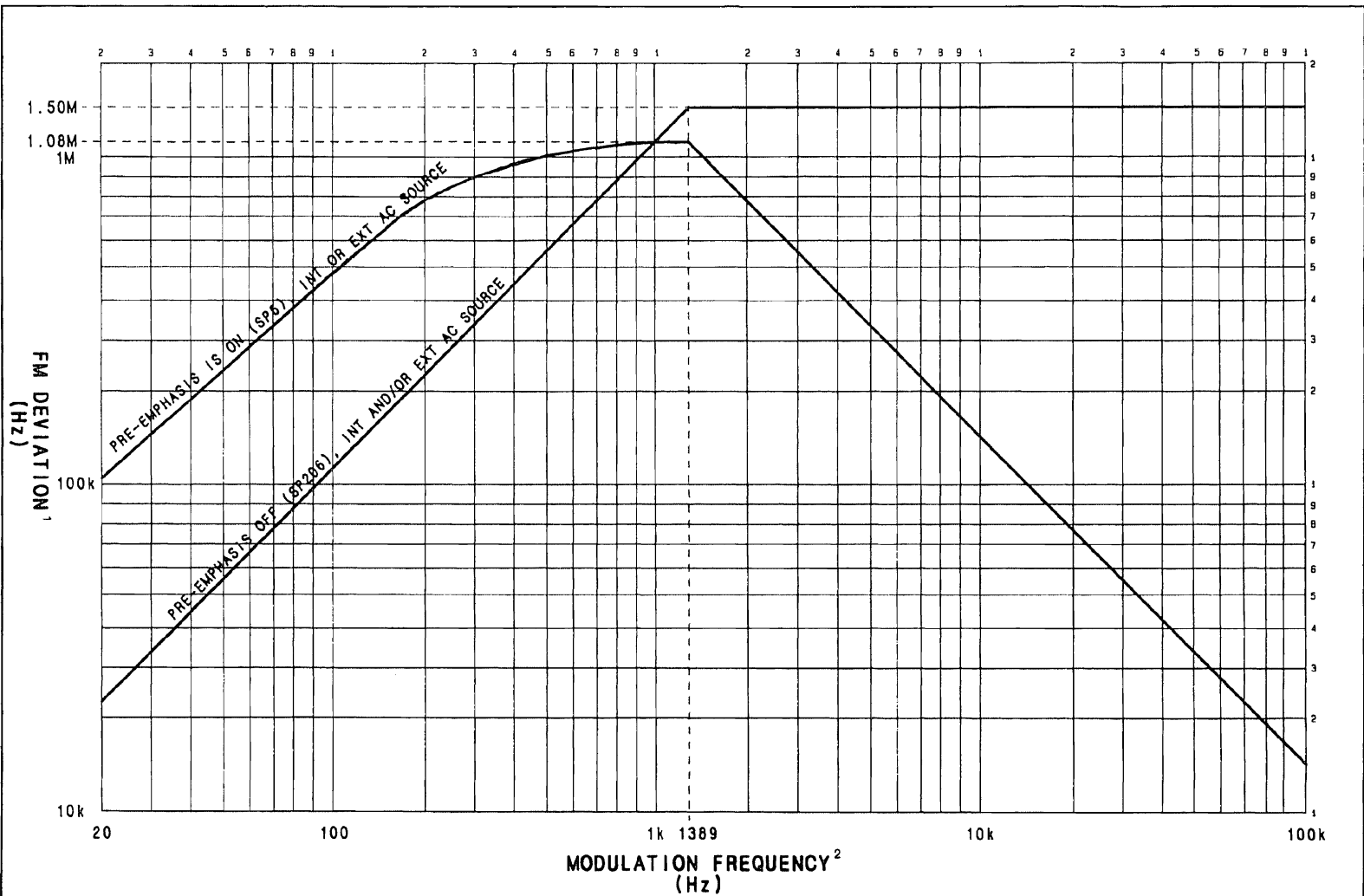

¹Values of FM deviation are for the RF frequency Band 9 (528.750001-1057.500000 MHz) and the Heterodyne Band (0.100000-132.187500 MHz). To calculate the FM deviation values for this y-axis for the frequency bands, divide each of the deviations by the appropriate number in Table 3-21. Also, when FM deviations exceed limits available for Bands 1 through 6, the Signal Generator automatically switches to the Heterodyne Band.

²For internal FM, the Modulation Frequency on the horizontal axis is the modulation frequency setting of the internal modulation oscillator. For external, ac-coupled FM, the Modulation Frequency on the horizontal axis is the audio rate of the external source. If the Modulation Frequency and FM limitations are exceeded (when using external sources) the Signal Generator could go out-of-lock which causes queued-up Hardware Error messages.

Figure 3-14. FM Deviation Limits with/without FM Pre-emphasis

Modulation, FM (cont'd)

Table 3-21. Factor for Y-Axis FM Deviation Quotient

Band	RF Frequency Range	Divide Number
10	1057.500001 to 2115.000000 (8642B only)	0.5
9	528.750001 to 1057.500000	1
8	264.375001 to 528.750000	2
7	132.187501 to 264.375000	4
6	66.093751 to 132.187500	8
5	33.046876 to 66.093750	16
4	16.523438 to 33.046875	32
3	8.261719 to 16.523437	64
2	4.130860 to 8.261718	128
1	0.100000 to 4.130859	16
Het	0.100000 to 132.187500	1

7. Low Distortion FM/ΦM On. This special function switches shaper circuitry into the FM/ΦM loop, reducing total harmonic distortion. With Special Function 7, total harmonic distortion is typically less than 0.03% for FM deviations less than 7% of maximum deviation. For example, if operating at 98 MHz (divide band 6; refer to Figure 3-13 on page 3-106), you can calculate the maximum allowed deviation to obtain the low-distortion performance by multiplying 7% times 187.5 kHz ($0.07 \times 187.5 \text{ kHz} = 13.13 \text{ kHz}$). To obtain a higher maximum deviation level, you could select the Het band (Special Function 8) which would have a maximum deviation of 7% times 1500 kHz ($0.07 \times 1500 \text{ kHz} = 100.5 \text{ kHz}$).

When using Special Function 7, external rates should be less than 50 kHz and internal rates should be less than 15.8 kHz. If rates exceed these limits, distortion may exceed 0.03%.

Total harmonic distortion is better than standard performance at all deviations and rates with this special function selected. The phase noise performance is degraded by approximately 20 dB at a 20 kHz offset, and by approximately 10 dB at a 200 kHz offset when in the Low Distortion FM/ΦM mode.

207. Low Distortion FM/ΦM Off. This special function switches out the shaper circuitry that is inserted with Special Function 7.

113. Modulation Frequency Correction Off. This special function disables the single-band calibration of the modulation frequency oscillator that normally occurs whenever the modulation oscillator frequency is set or the internal modulation oscillator is put into use. When this calibration is disabled, the typical modulation frequency switching time is decreased by approximately 200 ms. For more information, refer to "Speeding Up the Modulation Switching Time", page 3-132.

213. Modulation Frequency Correction On. This special function re-enables the modulation frequency correction disabled with Special Function 113.

115. Negative FM Polarity. This special function causes a positive voltage applied to the external FM/ΦM INPUT to cause a negative frequency shift and a negative voltage applied to cause a positive frequency shift.

215. Positive FM Polarity. This special function causes a positive voltage applied to the external FM/ΦM INPUT to cause a positive frequency shift and a negative voltage applied to cause a negative frequency shift.

Modulation, FM (cont'd)

116. DC FM Correction Off. This special function prevents the initial frequency correction that occurs when dc-coupled FM is selected. When dc-coupled FM is selected, the FM phase lock loop is open, causing an offset in the selected RF output frequency. To correct this initial offset, the dc-coupled signal is momentarily switched off, while an internal counter is used to determine the amount of RF frequency offset. The frequency offset is corrected, and the dc-coupled signal is switched back on (DC FM Correction). Disabling this correction causes a decrease in switching time by approximately 200 ms. During Phase Continuous Frequency Sweep (Special Function 123), dc-coupled FM is not possible when DC FM Correction is on.

216. DC FM Correction On. This special function re-enables the correction disabled with Special Function 116.

117. DC FM Update Mode On. With the FM loop unlocked, RF output frequency changes with a change in applied dc signal and with the normal drift of an unlocked VCO that occurs over time and temperature. In the DC FM Update Mode, the Signal Generator measures these changes in RF frequency and displays the changing RF output frequency on the display.

DC FM Update Mode requires continuous microprocessor and counter action resulting in a slight increase in noise, spurious signals and radio frequency interference (RFI). (These increases do not degrade specifications.)

The time required to turn on the internal modulation oscillator or change modulation frequency is increased by approximately 200 ms for all internal modulation types when the DC FM Update Mode is selected.

With Special Function 117 selected during RF frequency sweep, changes in RF frequency are not reflected on the display. During Phase Continuous Frequency Sweep (Special Function 123), dc-coupled FM is not possible when DC FM Update Mode is on.

217. DC FM Update Mode Off. This special function disables the DC FM update that occurs with Special Function 117.

118. AC-Coupled DC FM On. When the Signal Generator is in the normal ac-coupled FM mode, the external signal is applied to the FM loop through circuitry that uses a phase lock loop to ensure the accuracy of the output signal. In dc-coupled FM (DC FM), the phase lock loop is unlocked and the external signal is applied directly to the unlocked VCO. With Special Function 118 selected, the input signal is ac-coupled to the unlocked FM VCO blocking any applied dc component. (Typical low-frequency corner frequency is 1 Hz.) Using DC FM avoids the phase shifts associated with ac-coupled FM circuitry and allows maximum stereo separation. An external FM source must be in use with Special Function 118 to get these benefits.

218. AC-Coupled DC FM Off. This special function re-selects the dc coupling to the FM circuitry disabled with Special Function 118.

119. Disable Settling. This special function allows the Signal Generator's microprocessor to respond to new commands without waiting for the internal circuitry to settle. When using this special function, it's possible to select a function before the previous function has finished settling. When settling is disabled, response time is improved by up to 40 ms. Special Function 119 disables out-of-lock messages.

219. Re-enable Settling. This special function re-enables the settling that is disabled when Special Function 119 is selected.

248. Calibrate the Modulation Frequency Bands Again. This special function enables you to initiate the calibration sequence that normally only occurs during instrument power-up. This function can be used, for example, to recalibrate the modulation oscillator frequency bands if normal modulation frequency correction has been disabled with Special Function 113. Calibration typically takes one to two seconds.

Modulation, FM (cont'd)

Related Operating Instructions

Refer to **Modulation Oscillator** (page 3-131) for more information on the internal modulation oscillator that is the common source for all internal modulation as well as for MOD OUTPUT connector.

Refer to **Knob** (page 3-141) and **Step, Increment Set** (page 3-149) for information on using these to modify settings.

Refer to **Operating Messages** (page 3-177) if the instrument displays a message you want clarified.

Refer to **Special Functions** (page 3-165) for information about the way these are accessed.

MODULATION, Φ M

Description

The Signal Generator can phase modulate its RF output either with a variable internal modulation oscillator and/or with an ac- or dc-coupled external source applied to the FM/ Φ M INPUT.

Depending on the RF frequency selected, the 8642A/B has different limits on the possible Φ M deviation that can be selected. (See Figure 3-15 on page 3-120.) The Signal Generator normally selects the divide bands to obtain its FM deviation. However, if the divide band's maximum internal FM deviation boundaries are crossed, the Signal Generator can automatically switch to the heterodyne band which allows wider deviation Φ M at RF frequencies less than 132.187501 MHz. (Refer to RF Frequency, page 3-39, for more information about these different bands.)

Table 3-22. Φ M Operating Characteristics

Electrical Characteristics	Performance Limits	Conditions
Φ M Deviation Limitations	See Figure 3-15	
Accuracy	\pm (5% of setting +0.09 radians)	1 kHz rate
Resolution	0.7% of setting or 0.0004% of maximum deviation (whichever is larger)	
Distortion	<0.4%	1 kHz rate
Φ M 3 dB Bandwidth	20 Hz to 15 kHz dc to 15 kHz	Internal and external ac External dc

Modulation, Φ M (cont'd)

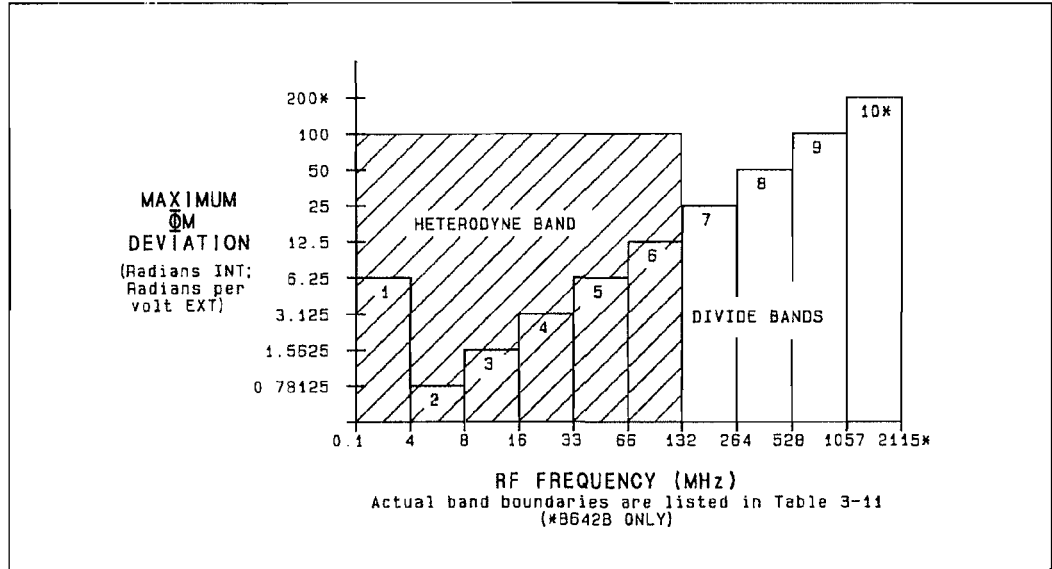

Figure 3-15. Φ M Deviation Limitations for each RF Frequency Band

You can determine whether the Signal Generator will select a divide band or the heterodyne band. Assume an RF frequency of 30 MHz, if you select a deviation of 3 radians, the Signal Generator will use divide band 4 since the maximum possible deviation for band 4 is 3.125 radians (unless Special Function 8, Prefer Heterodyne Band, is selected). If you select a deviation of 25 radians, the Signal Generator will automatically select the heterodyne band. (Note that the maximum possible deviation for the heterodyne band is 100 radians.)

Procedures

Note: Put the instrument in its initialized state by selecting .

Φ M can be configured to use either the Signal Generator's internal modulation oscillator, an external source, or combinations of the two sources.

INT

How to Set Φ M with the Internal Source (Using the Modulation Oscillator)

Source

Φ M ()

Rate

and the desired value of modulation frequency (in kHz or Hz).

Deviation

Φ M () and the desired value of Φ M deviation in radians ().

Modulation, Φ M (cont'd)

Example

Phase modulate the RF output using the internal modulation oscillator at a 10 kHz rate, with 12 radians Φ M deviation.

LOCAL (keys)		ENTRY	MODULATION SOURCE	ENTRY
	SHIFT	Φ M FM	INT	MOD FREQ
	DATA		ENTRY	DATA
	1 0 kHz mV	SHIFT	Φ M FM	1 2 rad %
HP-IB (program codes)	PMNT MF 10 KZ PM 12 RD*			

* These codes are not independent and might need to follow a specific sequence for entry. Refer to the discussion about Sequence Dependency, which begins on page 3-12 in the HP-IB portion of this Section III.

Display

MOD.FREQ	10.00KHZ	12.0RD	-140.00DB
		Φ M INT	AMPTD

The RF output is being internally phase modulated (as indicated by the Φ M and INT annunciators) Φ M deviation is 12.0 radians. Modulation frequency is set to 10.00 kHz. The cursor above the Φ M setting indicates that Φ M is the active function.

EXT AC, EXT DC

How to Set Φ M with an External Source

Source



Do not apply more than 15 Vpk maximum external voltage to the FM/ Φ M INPUT or damage to the Signal Generator's circuitry could result.

The external modulation source connects to the FM/ Φ M INPUT connector (input impedance of 600 ohms).

The external modulation signal level should be adjusted to a 1 Vpk (0.707 Vrms) sinewave input to the Signal Generator to get an actual Φ M deviation equal to the displayed Φ M deviation. For example, if a 1 Vpk external modulation source is provided, with the Signal Generator's Φ M deviation set to 50.0 radians per volt, the output has 50.0 radians Φ M deviation. (If the source voltage is reduced to 0.5 Vpk, and no other settings are changed, the output has 25.0 radians Φ M deviation.)

Modulation, Φ M (cont'd)

If the HI and LO annunciators are not displayed then the external modulation signal is between 0.95 Vpk and 1.05 Vpk. The HI, LO annunciators only apply to sinewave inputs. The HI, LO detectors do not monitor dc voltage input levels.

External Coupling

Any one of the following functions can be used to couple the external FM/ Φ M INPUT to the Φ M circuitry:

AC-Coupled Source

- EXT AC
This function selects the external, ac-coupled Φ M source (displaying the EXT and AC annunciators).
- INT + (EXT AC) (SHIFT EXT AC)
This function selects the external, ac-coupled Φ M source and internal Φ M source summed together (displaying the INT, EXT, and AC annunciators).

DC-Coupled Source

- EXT DC
This function selects the external, dc-coupled Φ M source for dc to 15 kHz rates (displaying the EXT and DC annunciators).
- INT + (EXT DC) (SHIFT EXT DC)
This function selects the external, dc-coupled Φ M source and internal Φ M source summed together (displaying the INT, EXT, and DC annunciators).

Rate

Determined by the external modulation source frequency.

NOTE

External modulation frequency is not monitored by the Signal Generator. The Signal Generator's modulation frequency display refers to the internal modulation oscillator only.

Deviation

Φ M (SHIFT FM) and the desired value of Φ M deviation in radians (RAD %) (per volt).

When using an external source, the Φ M deviation setting does not set the actual deviation, it sets the input sensitivity per volt. A linear relationship exists between the Φ M deviation setting and the external voltage applied (for voltages less than approximately 1.2 Vpk).

NOTE

With simultaneous internal and external modulation, the sum of the internal and external signals should not cause the Φ M deviation to exceed the limits mentioned on page 3-119. If these limits are exceeded, the Signal Generator could go out of lock which causes queued up Hardware Error messages. Also, the external FM/ Φ M INPUT does not respond linearly to inputs greater than approximately 1.2 Vpk.

Modulation, Φ M (cont'd)

Example

Phase modulate the RF output with an external, 1 Vpk, dc-coupled source, 2 radians Φ M deviation, at a rate determined by the external source's frequency.

LOCAL (keys)		ENTRY	MODULATION SOURCE		ENTRY	DATA
	SHIFT	Φ M FM	EXT DC	SHIFT	Φ M FM	2 rad %
HP-IB (program codes)	PMXD PM 2 RD*					

* These codes are not independent and might need to follow a specific sequence for entry. Refer to the discussion about Sequence Dependency, which begins on page 3-12 in the HP-IB portion of this Section III.

Display

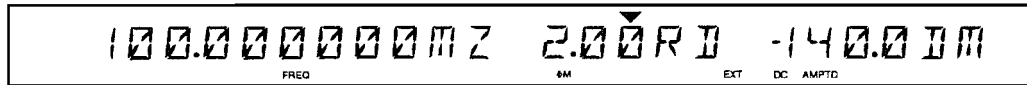

The RF output is being externally phase modulated with an external dc-coupled source (as indicated by the Φ M, EXT, and DC annunciators). Φ M deviation setting is 2.00 radians per volt. Modulation frequency is not monitored by the Signal Generator when an external modulation source is used. The cursor above the Φ M setting indicates Φ M is the active function.

HP-IB Codes

Keys	Codes
Φ M	PM
MOD FREQ	MF
INT	PMNT
EXT AC	PMXA
EXT DC	PMXD
INT+ (EXT AC)	PMBA

Keys	Codes
INT+ (EXT DC)	PMBD
OFF ON	PMOF, PMON
rad	RD
kHz	KZ
Hz	HZ
SPCL	SP

Comments

Modulation Types Not Possible During RF Frequency Sweep

During Stepped Frequency Sweep, FM and Φ M are allowed in manual or single sweep mode only. During Phase Continuous Frequency Sweep (Special Function 123), all modulation types are allowed.

Modulation Switching Time

The time required to turn on the internal modulation oscillator or to switch between modulation frequencies can be reduced by approximately 200 ms (depending on modulation frequency), with a loss in modulation frequency accuracy, by selecting Modulation Frequency Correction Off (Special Function 113). For more information, refer to "Speeding Up Modulation Switching Time" on page 3-132.

Modulation, Φ M (cont'd)

Selecting Heterodyne Band Operation

Special Function 8 (Prefer Het Band) can be used to cause the Signal Generator to operate in the heterodyne band regardless of Φ M deviation, whenever RF frequency is less than 132.187501 MHz. This function prevents the Signal Generator from switching from the heterodyne band when it would be possible to use the divide bands. Refer to "How to Select the Het Band" on page 3-41.

Mixed Modulation

The Signal Generator can simultaneously modulate the RF signal with more than one modulation type. The Signal Generator does not allow simultaneous AM and pulse modulation or FM and Φ M. Φ M is allowed in the following combinations:

Any one of these types:

- Internal Φ M,
- External ac- or dc-coupled Φ M, or
- Internal + external ac- or dc-coupled Φ M

With any one of the following:

- Internal AM,
- External ac- or dc-coupled AM,
- Internal + external ac- or dc-coupled AM,
- Internal pulse modulation, or
- External dc-coupled pulse modulation.

NOTE

All internal modulation sources use the internal modulation oscillator, therefore all internal modulation, as well as MOD OUTPUT, have the same modulation frequency.

Spurious Signals (Spurs) That Occur with the Internal Source

Internally generated spurs (with levels specified less than -100 dBc) might be present when the internal modulation oscillator is in use. These spurs will be eliminated when no internal modulation source is modulating the carrier, and the modulation oscillator output (MOD OUT) is off.

HP-IB. Sequence Dependency

Φ M settings are sometimes coupled with other functions. Therefore, HP-IB codes may need to be entered in a particular sequence when accessing combinations of these functions. Refer to the discussion about Sequence Dependency, which begins on page 3-12 in the HP-IB portion of this Section III.

Related Special Functions

7. Low Distortion FM/ Φ M On. In the Φ M mode, the low distortion function is limited by the actual frequency deviation. Therefore, to use Special Function 7 for Φ M, you need to calculate frequency deviation as the phase deviation (in radians) times the modulation frequency (in Hz). Frequency deviation must be less than 7% of the maximum allowable frequency deviation for the RF frequency chosen.

207. Low Distortion FM/ Φ M Off. This special function switches out the shaper circuitry inserted with Special Function 7.

Modulation, Φ M (cont'd)

113. Modulation Frequency Correction Off. This special function disables the single-band calibration of the modulation frequency oscillator that normally occurs whenever the modulation oscillator frequency is set or the internal modulation oscillator is put into use. When this calibration is disabled, the typical modulation frequency switching time is decreased by approximately 200 ms. For more information, refer to "Speeding Up Modulation Switching Time", page 3-132.

213. Modulation Frequency Correction On. This special function re-enables the modulation frequency correction disabled with Special Function 113.

114. Negative Φ M Polarity. This special function causes a positive voltage applied to the external FM/ Φ M INPUT to cause a phase lag and a negative voltage applied to cause a phase lead.

214. Positive Φ M Polarity. This special function causes a positive voltage applied to the external FM/ Φ M INPUT to cause a phase lead and a negative voltage applied to cause a phase lag.

119. Disable Settling. This special function allows the Signal Generator's microprocessor to respond to new commands without waiting for the internal circuitry to settle. When using this special function, it's possible to select a function before the previous function has finished settling. When settling is disabled, response time is improved by up to 40 ms. Special Function 119 disables out-of-lock messages.

219. Re-enable Settling. This special function re-enables the settling that is disabled when Special Function 119 is selected.

248. Calibrate the Modulation Frequency Bands Again. This special function enables you to initiate the calibration sequence that normally only occurs during instrument power-up. This function can be used, for example, to recalibrate the modulation oscillator frequency bands if normal modulation frequency correction has been disabled with Special Function 113. Calibration typically takes one to two seconds.

Related Operating Instructions

Refer to **Modulation Oscillator** (page 3-131) for more information on the internal modulation oscillator that is the common source for all internal modulation as well as for the MOD OUTPUT connector.

Refer to **Knob** (page 3-141) and **Step, Increment Set** (page 3-149) for information on using these to modify settings.

Refer to **Operating Messages** (page 3-177) if the instrument displays a message you want clarified.

Refer to **Special Functions** (page 3-165) for information about the way these are accessed.

MODULATION, PULSE

Description The Signal Generator can pulse modulate its RF output either with the variable internal modulation oscillator or with a dc-coupled external source applied to the AM/PULSE INPUT.

When the internal pulse modulation source is selected, the pulse repetition rate can be changed by varying the modulation oscillator frequency. The duty cycle will always be 50% for internal pulse modulation.

Table 3-23. Pulse Modulation Operating Characteristics

Electrical Characteristics	Performance Limits	Conditions
Pulse Modulation		
Pulse On/Off Ratio	>30 dB >45 dB	Output Levels $\leq +15$ dBm ¹ RF Frequency ≤ 1057.5 MHz RF Frequency > 1057.5 MHz ²
Rise/Fall Time	<3.5 μ s	10% to 90%
Minimum Pulse Width	6 μ s	
Maximum Repetition Frequency	50 kHz	
Nominal Peak Input Level Required	1.5V	
¹ Output level accuracy is typically ± 3 dB. ² 8642B, Band 10.		

Procedures Note: Put the instrument in its initialized state by selecting **INSTR PRESET**.

INT

How to Set Pulse Modulation with the Internal Source (Using the Modulation Oscillator)

Source

PULSE (**SHIFT** **AM**) **INT**

Rate

MOD FREQ and the desired value of modulation frequency (in kHz or Hz).

Pulse Modulation

PULSE (**SHIFT** **AM**) and **OFF ON**

Modulation, Pulse (cont'd)

Example

Pulse modulate the RF output using the internal modulation oscillator at a 2 kHz rate (starting with pulse modulation off).

LOCAL (keys)	SHIFT	ENTRY PULSE AM	MODULATION SOURCE INT	ENTRY MOD FREQ	DATA 2 kHz mV	SHIFT	ENTRY PULSE AM OFF ON
	<div style="text-align: center;">  (program codes) </div> <div style="text-align: center; margin-top: 10px;"> PLNT MF 2 KZ PLON </div>						

Display

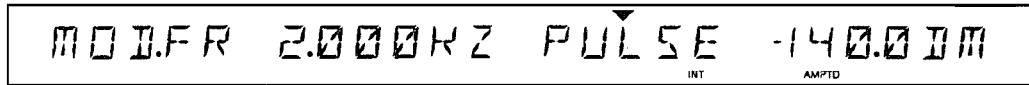

The RF output is being internally pulse modulated (as indicated by the word PULSE and the annunciator INT). Modulation frequency is set to 2 kHz. The duty cycle is 50%. The cursor above the pulse modulation display indicates that pulse modulation can be toggled off and on by selecting the **OFF ON** key. (Note that the AM annunciator is displayed if the word "PULSE" can't be displayed.)

EXT DC

How to Set Pulse Modulation with an External Source

Source



Do not apply more than 15 Vpk to the AM/PULSE INPUT or damage to the Signal Generator's circuitry could result.

Connect the external modulation source to the AM/PULSE INPUT connector (input impedance of 600 ohms) and select PULSE (**SHIFT** **AM**) **EXT DC**. Adjust the external modulation signal to a level above 1.5 volts. Above 1.5 volts the output is on and below 1.5 volts the output is off.

Pulse repetition rate and duty cycle are determined by the external pulse generating source. (Note that the HI, LO annunciators are not used for pulse modulation.)

NOTE

External modulation frequency is not monitored by the Signal Generator. The Signal Generator's modulation frequency display refers to the internal modulation oscillator only.

Modulation, Pulse (cont'd)

Example Pulse modulate the RF output with an external dc-coupled source, at a rate and duty cycle determined by the external source (starting with pulse modulation off.)

LOCAL (keys)		ENTRY	MODULATION SOURCE		ENTRY
	SHIFT	PULSE AM	EXT DC	SHIFT	PULSE AM OFF ON
HP-IB (program codes)	PLXD PLON				

Display

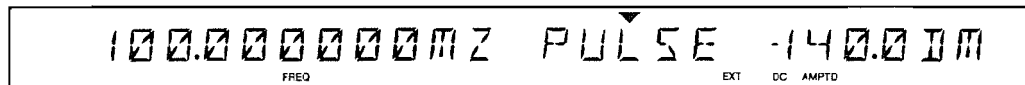

The RF output is being externally pulse modulated with an external, dc-coupled source (as indicated by the word **PULSE** and the annunciators **EXT** and **DC**). The cursor above the pulse modulation display indicates that pulse modulation can be toggled off and on by selecting the **OFF ON** key.

**HP-IB
Codes**

Keys	Codes
PULSE	PL
MOD FREQ	MF
INT	PLNT
EXT DC	PLXD
OFF, ON	PLOF, PLON
kHz	KZ
Hz	HZ
SPCL	SP

Comments

Modulation Restrictions with other Functions

Pulse modulation and AM are not possible during amplitude sweep. Also, AM and pulse modulation are not possible when ALC Off (Special Function 4) is selected.

Spurious Signals (Spurs) That Occur with the Internal Source

Internally generated spurs (with specified levels less than -100 dBc) might be present when the internal modulation oscillator is in use. These spurs will be eliminated when no internal modulation source is modulating the carrier, and the modulation oscillator output (MOD OUT) is off.

Modulation Switching Time

The time required to turn on the internal modulation oscillator or to switch between modulation frequencies can be reduced by approximately 200 ms (the time depends on modulation frequency), with a loss in modulation frequency accuracy, by selecting Modulation Frequency Correction Off (Special Function 113). For more information, refer to "Speeding Up Modulation Switching Time" on page 3-132.

Modulation, Pulse (cont'd)

Mixed Modulation

The Signal Generator can simultaneously modulate the RF signal with more than one modulation type. The Signal Generator does not allow simultaneous AM and pulse modulation or FM and Φ M. Pulse modulation is allowed in the following combinations:

Either

- Internal pulse modulation or
- External dc-coupled pulse modulation

With any one of the following:

- Internal FM,
- External ac- or dc-coupled FM,
- Internal + external ac- or dc-coupled FM,
- External low rate FM (Special Function 5),
- Internal + external low rate FM (Special Function 112),
- Internal Φ M,
- External ac- or dc-coupled Φ M, or
- Internal + external ac- or dc-coupled Φ M.

NOTE

All internal modulation sources use the internal modulation oscillator, therefore all internal modulation, as well as MOD OUTPUT, will have the same modulation frequency.

Related Special Functions

113. Modulation Frequency Correction Off. This special function disables the single-band calibration of the modulation frequency oscillator that normally occurs whenever the modulation oscillator frequency is set or the internal modulation oscillator is put into use. When this calibration is disabled, the typical modulation frequency switching time is decreased by approximately 200 ms. For more information, refer to "Speeding Up Modulation Switching Time" on page 3-132.

213. Modulation Frequency Correction On. This special function re-enables the modulation frequency correction disabled with Special Function 113.

248. Calibrate the Modulation Frequency Bands Again. This special function enables you to initiate the calibration sequence that normally only occurs during instrument power-up. This function can be used, for example, to recalibrate the modulation oscillator frequency bands if normal modulation frequency correction has been disabled with Special Function 113. Calibration typically takes one to two seconds.

Related Operating Instructions

Refer to **Modulation Oscillator** (page 3-131) for more information on the internal modulation oscillator that is the common source for all internal modulation as well as for the MOD OUTPUT connector.

Refer to **Operating Messages** (page 3-177) if the instrument displays a message you want clarified.

Refer to **Special Functions** (page 3-165) for information about the way these are accessed.

MODULATION OSCILLATOR

Description The Signal Generator's internal modulation oscillator is the modulation source for internal AM, FM, Φ M, and pulse modulation. The modulation oscillator signal is also the source for the MOD OUTPUT connector when the modulation output level is set.

Internal modulation (such as AM, FM, Φ M, and pulse modulation) is described in those specific operating instructions. However, the modulation frequency and the modulation output level are discussed here.

Table 3-24. Modulation Oscillator Operating Characteristics

Electrical Characteristics	Performance Limits	Conditions
Frequency Range Frequency Resolution Frequency Accuracy	20 Hz to 100 kHz 1% of setting 2% of setting	
Output Distortion (>0.5 Vpk)	<0.02% <0.15%	0.02 to 15.8 kHz >15.8 kHz
Output Level Range Output Level Resolution Output Level Accuracy	0 to 3.3 Vpk 4 mV $\pm(4\% + 15 \text{ mV})$	into 600 ohms Within 1s
Output Impedance	600 ohms $\pm 10\%$	

Procedures Note: Put the instrument in its initialized state by selecting **INSTR PRESET**.

MOD FREQ

How to Set Modulation Frequency

MOD FREQ and the value of the desired output frequency (in kHz or Hz).

The modulation frequency cannot be turned off with the **OFF ON** key, but the modulation oscillator can be considered off if the modulation output (MOD OUT) is off and no internal modulation source is in use.

MOD OUT

How to Set Modulation Output Level

The Signal Generator can be set to produce a sinewave signal at the MOD OUTPUT connector by selecting:

MOD OUT (**SHIFT** **MOD FREQ**) and the desired peak-voltage output level (in V or mV).

Modulation Oscillator (cont'd)

Example

Set the Signal Generator to output a 2 Vpk, 10 kHz signal at the MOD OUTPUT connector.

LOCAL (keys)	ENTRY	DATA				ENTRY	DATA	
		1	0				2	
 (program codes)	MF 10 KZ ML 2 VL							

Display

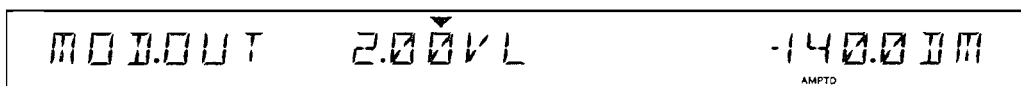

The modulation output level has been set to 2.00V.

Any function which is using the modulation oscillator as a source, (MOD OUTPUT or internal AM, FM, Φ M, or pulse modulation), now has a rate of 10.00 kHz regardless of any previous modulation oscillator rate setting. The cursor above the modulation output value indicates Modulation Output is the active function.

HP-IB Codes

Keys	Codes
MOD FREQ	MF
MOD OUT level	ML
kHz	KZ
Hz	HZ
V	VL
mV	MV
SPCL	SP

Comments

Speeding Up Modulation Switching Time

At instrument turn on, all modulation oscillator frequency bands are characterized and given a calibration factor (Modulation Frequency Calibration). When the modulation oscillator frequency is set or the modulation oscillator placed in use, the selected modulation oscillator frequency and its individual frequency band are recalibrated to correct for inaccuracies due to changes in temperature (Modulation Frequency Correction). A single calibration of all modulation oscillator frequency bands can be initiated using Special Function 248.

If faster switching between modulation frequencies is desired, Modulation Frequency Correction can be disabled by selecting Modulation Frequency Correction Off (Special Function 113). This special function decreases switching time by approximately 200 ms. Automatic modulation frequency correction can be re-enabled by selecting

Modulation Oscillator (cont'd)

Special Function 213. When modulation frequency correction is disabled, the Signal Generator does not automatically recalibrate at each modulation frequency when one is selected. Instead, the instrument uses, as its calibration data, the previously calculated calibration factor for each frequency band. The accuracy of previously calculated calibration factors depends on variations in temperature from the time the calibration factor was selected. Typically, 2% accuracy can be degraded to 5% if recalibration is not performed when the Signal Generator is subjected to temperature changes of 50°C.

DC FM Update Mode (Special Function 117) also increases modulation frequency switching by up to 200 ms. (Refer to Special Function 117 description in **Modulation, FM** on page 3-116).

Spurious Signals (Spurs) That Occur with the Internal Source

Internally generated spurs (with levels specified less than -100 dBc) might be present when the internal modulation oscillator is in use. These spurs will be eliminated when no internal modulation source is modulating the carrier, and the modulation oscillator output (MOD OUT) is off.

Modulation Output Phase

The phase of the modulation output (MOD OUTPUT) is 180° out-of-phase with the internal use of the modulation oscillator.

Underranging Specified Modulation Oscillator Frequency

Modulation oscillator frequencies as low as 10 Hz can be selected. However, the modulation oscillator's signal characteristics are not specified below 20 Hz.

Related Special Functions

113. Modulation Frequency Correction Off. This special function disables the single-band calibration of the modulation frequency oscillator that normally occurs whenever the modulation oscillator frequency is set or the internal modulation oscillator is put into use. When this calibration is disabled, the typical modulation frequency switching time is decreased by approximately 200 ms. For more information, refer "Speeding Up Modulation Switching Time" on page 3-132.

213. Modulation Frequency Correction On. This special function re-enables the modulation frequency correction disabled with Special Function 113.

248. Calibrate the Modulation Frequency Bands Again. This special function enables you to initiate the calibration sequence that normally only occurs during instrument power-up. This function can be used, for example, to recalibrate the modulation oscillator frequency bands if normal modulation frequency correction has been disabled with Special Function 113. Calibration typically takes one to two seconds.

Modulation Oscillator (cont'd)

Related Operating Instructions

Refer to **Modulation, AM** (page 3-97); **Modulation, FM** (page 3-105); **Modulation, Φ M** (page 3-119); or **Modulation, Pulse** (page 3-127) for specific modulation information as well as internal and external source information.

Refer to **Knob** (page 3-141) and **Step, Increment Set** (page 3-149) for information on using these to modify settings.

Refer to **Operating Messages** (page 3-177) if the instrument displays a message you want clarified.

Refer to **Special Functions** (page 3-165) for information about the way these are accessed.

SETTING MODIFICATIONS CONTENTS

<p>Figure 3-16. Functions Relating to Modifying Settings 3-136</p> <p>INSTRUMENT PRESET, PARTIAL PRESET .. 3-137</p> <p>POWER 3-137</p> <p style="padding-left: 20px;">How Turning the Power On Affects Instrument Settings 3-137</p> <p>INSTR PRESET 3-138</p> <p style="padding-left: 20px;">How Instrument Preset Affects Instrument Settings 3-138</p> <p style="padding-left: 20px;">Table 3-25. Instrument Preset Configuration ... 3-138</p> <p>PARTIAL 3-139</p> <p style="padding-left: 20px;">How Partial Preset Affects Instrument Settings 3-139</p> <p style="padding-left: 20px;">HP-IB Codes 3-139</p> <p style="padding-left: 20px;">Comments 3-139</p> <p>KNOB 3-141</p> <p style="padding-left: 20px;">←, → 3-141</p> <p style="padding-left: 40px;">How to Control Knob Resolution Using the Cursor Positioning Keys 3-141</p>	<p>INCR 3-142</p> <p style="padding-left: 20px;">How to Control Knob Resolution by Setting Knob Increment 3-142</p> <p>HOLD</p> <p style="padding-left: 20px;">How to Use Knob Hold to Maintain Control of a Function's Value when Another Function Is Active 3-143</p> <p style="padding-left: 20px;">HP-IB Codes 3-144</p> <p style="padding-left: 20px;">Comments 3-145</p> <p style="padding-left: 20px;">The Meaning of Multiple Cursors 3-145</p> <p>STEP, INCREMENT SET 3-149</p> <p>INCR SET 3-149</p> <p style="padding-left: 20px;">How to Set Increment Size 3-149</p> <p style="padding-left: 20px;">↑, ↓ 3-149</p> <p style="padding-left: 20px;">How to Increment a Function 3-149</p> <p style="padding-left: 20px;">How to Display the Increment Value 3-150</p> <p style="padding-left: 20px;">HP-IB Codes 3-150</p> <p style="padding-left: 20px;">Comments 3-151</p> <p>ENTRY OFF 3-153</p>
--	---

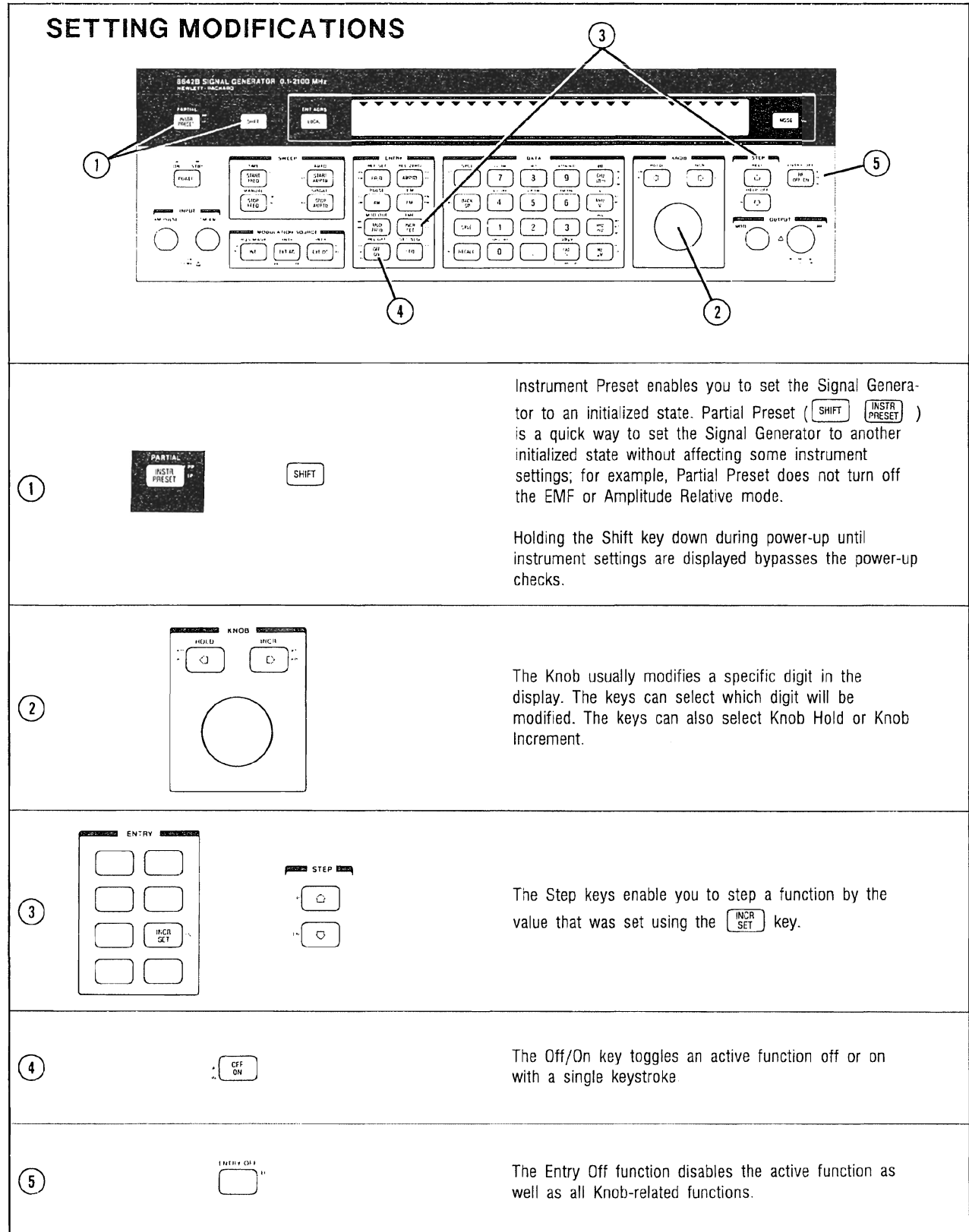

Figure 3-16. Functions Related to Modifying Settings

INSTRUMENT PRESET, PARTIAL PRESET

Description Signal Generator settings can be reset by switching the Power from standby to on, selecting Instrument Preset, or by selecting Partial Preset.

The instrument is turned on by switching **POWER** from STBY to ON. When it is turned on, the Signal Generator goes through a sequence of internal checks. If the instrument encounters no problems, it sets itself to the initialized state that is set up with Instrument Preset. If any failures occur during the power-up self check, hardware messages are queued up to be selected with the **MSSG** key. (If the messages encountered cannot be found in the **Operating Messages** operating instruction beginning on page 3-177, refer to the Service Manual.) The power-up self check takes approximately 20 seconds.

Instrument Preset is selected with **INSTR PRESET**. This function sets the Signal Generator to the initialized state described on page 3-138.

Partial Preset is selected with **PARTIAL (SHIFT INSTR PRESET)** and enables you to set the instrument to a known state without losing some frequently used settings. This function maintains some current instrument settings, turns off others (while maintaining their last-selected values so they can be selected "on" with the **OFF ON** key), and resets other settings to Instrument Preset values. Because Partial Preset does not reset the entire instrument state, it takes less time than does Instrument Preset. (For example, Partial Preset may take only a few hundred milliseconds while Instrument Preset takes approximately two seconds).

Procedures

POWER

How Turning the Power On Affects Instrument Settings

Switching the **POWER** switch from STBY to ON changes the instrument settings to those listed for Instrument Preset (refer to "How Instrument Preset Affects Instrument Settings" on the following page) plus the following:

- ◆ HP-IB is set to local mode.
- ◆ The Signal Generator is configured to an unaddressed condition.
- ◆ The HP-IB address is set to that of the internal switch if RAM memory has been lost. (RAM memory could be lost, for example, if the battery loses its charge.) (Refer to **HP-IB Address** on page 3-8.)
- ◆ If RAM memory has been lost, the sequence function is set to a start register of 00 and a stop register of 50.

Instrument Preset, Partial Preset (cont'd)

INSTR PRESET

How Instrument Preset Affects Instrument Settings

Selecting **INSTR PRESET** affects the instrument settings in the following ways:

- Re-configures the instrument to the instrument preset configuration listed in Table 3-25 below.
- Turns off special functions with code numbers less than 200.
- Disables Knob Increment and Knob Hold.
- Sets the next Save, Recall register number.
- Clears any uncompleted HP-IB messages.
- Sets the HP-IB RQS mask to "nothing enabled to pull SRQ".
- Clears the HP-IB Status Byte except bits 3 (Local/Remote) and 4 (Ready) (unless there is an unresolved Hardware Error).
- Selects RF frequency as the active function.

Table 3-25. Instrument Preset Configuration

Function	Initialized State	Initialized Value	Step Size	Knob Resolution
RF Frequency		100.0 MHz	10 MHz	1 MHz
Start Frequency	OFF	100.0 MHz	10 MHz	1 MHz
Stop Frequency	OFF	100.1 MHz	10 MHz	1 MHz
Frequency Reference	OFF	100.0 MHz	DNA	DNA
Amplitude	ON	-140.0 dBm	1 dB	0.1 dB
Start Amplitude	OFF	-140.0 dBm	1 dB	0.1 dB
Stop Amplitude	OFF	-135.0 dBm	1 dB	0.1 dB
Amplitude Reference	OFF	1.00 μ V	DNA	DNA
EMF Mode	OFF	DNA	DNA	DNA
AM Depth	OFF	50%, Internal Source	10%	0.1%
FM Deviation	OFF	50.0 kHz, Internal Source	5.0 kHz	0.1 kHz
Φ M Deviation	OFF	1.0 radians, Internal Source	0.1 radians	0.01 radians
Pulse Modulation	OFF	External DC Source	DNA	DNA
Modulation Frequency		1.000 kHz	1.000 kHz	0.001 kHz
Modulation Output Level	OFF	1.00V	0.1V	0.01V
Frequency Sweep Mode		Auto	DNA	DNA
Amplitude Sweep Mode		Auto	DNA	DNA
Sweep Time		500 ms	100 ms	1 ms
DNA = Does Not Apply				

Instrument Preset, Partial Preset (cont'd)

PARTIAL

How Partial Preset Affects Instrument Settings

Selecting PARTIAL () affects settings as follows:

- Partial Preset does not change the setting of:
 - RF Frequency
 - Amplitude Reference
 - EMF Mode
 - Sweep Mode (Auto, Manual, or Single selection)
 - HP-IB Status Byte
 - HP-IB RQS Mask

- Partial Preset turns off the following functions but maintains their last-selected values as "on" settings that can be selected with the key:
 - AM Depth
 - FM Deviation
 - ΦM Deviation
 - Pulse Modulation
 - Modulation Output Level
 - Start Frequency
 - Stop Frequency
 - Start Amplitude
 - Stop Amplitude
 - Frequency Reference

- Partial Preset sets the following functions to the initialized states and values listed in Table 3-25 on the previous page.
 - Modulation Frequency
 - Sweep Time

- Partial Preset also:
 - Maintains the next Save, Recall register.
 - Disables Knob Hold and Knob Increment.
 - Maintains all Increment Set values and Knob cursor positions.
 - Turns off all special functions with code numbers less than 200.
 - Clears any uncompleted HP-IB messages.
 - Selects RF Frequency as the active function.
 - Selects RF.OFF. (which does not change the output attenuators but maintains the last selected value as the "on" setting that can be selected with the key).

HP-IB Codes

Keys	Codes
INSTR PRESET	IP
PARTIAL	PP

Comments

Bypassing the Power-Up Self Check

The Signal Generator takes approximately 20 seconds to perform the initial checks done when is switched from STBY to ON. This time delay can be avoided and these checks can be bypassed by holding down the key during turn on: First hold down the key, then switch to ON, holding until instrument settings are displayed.

KNOB

Description The Knob is a variable stepping control. It actually changes the active function in steps that are determined either by 1) the cursor position and the rate at which you turn the Knob or 2) the increment set value if the Knob Increment function is selected. The Knob can control the following functions:

- Frequency
- Start Frequency
- Stop Frequency
- Amplitude
- Start Amplitude
- Stop Amplitude
- AM Depth
- FM Deviation
- ΦM Deviation
- Modulation Frequency
- Modulation Output
- Sweep Time
- Manual Sweep (for either amplitude sweep or frequency sweep)
- Help
- Phase on Knob and Step keys, (Special Function 250)

Knob Hold enables the Signal Generator to fix the Knob control on a function even if it is no longer the active function. With Knob Hold, the Step keys and Data keys enable control of the new active function while allowing the Knob to continue control of the "held" function.

While Knob Increment is selected, the Knob is less sensitive to the Knob rotation rate in affecting how much a setting is changed as the Knob is turned. This gives you the capability to make individual precise steps with more control, using the Knob.

Procedures The Signal Generator powers up with the Knob function enabled with RF frequency as the active function. Therefore, unless the Knob is disabled (for example, by selecting ENTRY OFF (), any rotation of the Knob changes the value of the active function.

Note: Put the instrument in its initialized state by selecting .

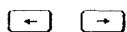

How to Control Knob Resolution Using the Cursor Positioning Keys

The cursor position specifies the Knob resolution (unless Knob Increment is selected). For example, a cursor above the 2 in a 260 HZ FM display indicates that the Knob will change the FM value in 100 Hz steps. You can re-position the cursor with the and keys to change Knob resolution by a factor of ten.

Knob (cont'd)

Example of Controlling Knob Resolution Using the Cursor Positioning Keys
 RF frequency is set to 100 MHz. Set the Knob to step this value in 1 kHz steps.

First set the RF Frequency to 100 MHz, then:

	ENTRY	KNOB
LOCAL (keys)	FREQ	◀ ▶ ▸
HP-IB (program codes)	FRKR FRKR FRKR	

Display

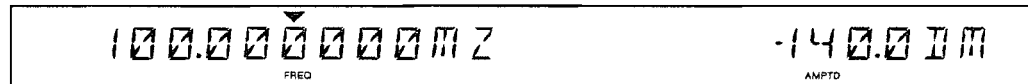

The initialized Knob resolution is 1 MHz at both instrument turn-on and Instrument Preset. Selecting the right cursor key three times has moved the cursor to the 1 kHz digit. Turning the Knob clockwise will now increment the frequency in 1 kHz steps.

INCR

How to Control Knob Resolution by Setting Knob Increment

Knob Increment puts the increment set value on the Knob so you can change a function's value by the increment set values. To set an increment set value, select **INCR SET** followed by the desired value. (Refer to **Step, Increment Set** on page 3-149.)

To put the increment set value on the Knob:

KNOB INCR (**SHIFT** **→**)

The cursor is displayed above the second letter of the active function's units display when Knob Increment is selected. (For example, if FM deviation is the active function and is set to 900 HZ, the cursor is over the "Z".)

As you change active functions, Knob Increment will continue to remain selected. This means that with any active function, the Knob will change the function's setting by the increment set value.

You can turn off the Knob Increment function (and all other Knob-related functions) by selecting **ENTRY OFF** (**SHIFT** **RF OFF/ON**). You can also turn off Knob Increment alone by selecting one of the cursor positioning keys (**←** or **→**).

Knob (cont'd)

Example of Controlling Knob Resolution by Setting Knob Increment

Use the Knob to increment frequency by 25 kHz per step.

LOCAL (keys)	ENTRY	DATA		KNOB
	FREQ INCR SET	2 5 kHz mV	SHIFT	INCR
HP-IB (program codes)	FRIS 25 KZ KI			

Display

<p style="text-align: center;">FREQ</p>	<p style="text-align: center;">AMPTD</p>
---	--

Knob resolution has been set with the Knob Increment function as indicated by the cursor over the "Z". Turning the Knob will step frequency in 25 kHz steps.

HOLD

How to Use Knob Hold to Maintain Control of a Function's Value When Another Function Is Active

Knob Hold is a way to maintain Knob control over one function while acquiring the ability to change another function's value with the Step and Data keys and the Off/On key. Knob Hold can be turned on by:

Selecting the desired active function, then HOLD (**SHIFT** **←**), **OFF ON**.

Knob Control is "held" on the selected function as indicated by the two cursors over that "held" function. Selecting a different function key sets that different function as the active function (which can be acted on only by the Step keys, or Data keys, or the Off/On key). Knob control does not transfer to this new active function, but stays with the function that was active when Knob Hold was selected. (During Knob Hold, a function with just one cursor is not controlled by the Knob; the function having two cursors is controlled by the Knob.)

Turn off Knob Hold by selecting Knob HOLD (**SHIFT** **←**) **OFF ON**. Knob Hold (along with all other Knob-related functions) can also be turned off by selecting ENTRY OFF (**SHIFT** **RF OFF/ON**).

Knob (cont'd)

Example of Using Knob Hold To Maintain Control of a Function's Value When It Is No Longer Active
 Select Knob Hold on RF frequency.

LOCAL (keys)	ENTRY		Knob	ENTRY
	FREQ	SHIFT	HOLD ↩	OFF ON
HP-IB (program codes)	FRKHON			

Display

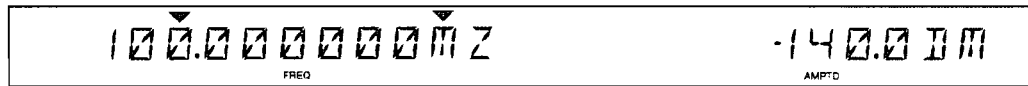

The frequency function is "held" on the Knob as indicated by the two cursors above the frequency value. Therefore, the Knob can be used to change that value even when another active function is selected.

Select amplitude as the active function by selecting the **AMPTD** key.

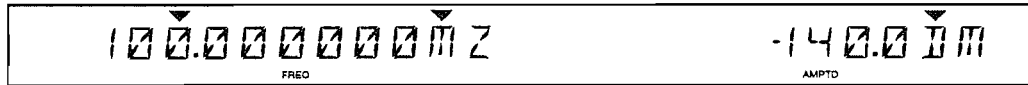

The cursor over the first letter of the units specifier ("D" in DM) indicates that Knob Hold has been selected on some function. (There is no cursor over any of the amplitude digits because the Knob is "held" on RF frequency which has two cursors over its setting.) Now, turning the Knob changes frequency while selecting the Step keys (or Data keys or **RF OFF ON**) changes amplitude. All this can be done without needing to select the active function's keys again.

HP-IB Codes

Keys	Codes
Knob INCR	KI
Knob HOLD ON	KHON*
Knob HOLD OFF	KHOF
ENTRY OFF	EO
*Function should be preceded by an active function code.	

Knob (cont'd)

Comments

You Can Use the Knob to Determine Function Limits

The Knob can be used to determine the approximate limits for all function settings. However, the limits reached with the Knob will not cause the Signal Generator to display a message describing the reason for the limitation. Use a Data entry beyond the limitation to cause the Signal Generator to describe a limitation.

Undisplayed Digits May Appear to Affect Maximum Settings

You can step in increment set values that will not be displayed when the resolution of the current setting is coarser than the increment set value. For example, with FM deviation set to 1.30 MHz, an increment change of 1 kHz will not be displayed until 10 increments have been stepped. Consequently, if at any time you step the displayed setting by that undisplayed increment setting, and then turn the Knob, the Signal Generator may seem to not be able to reach its maximum value. For example, stepping from 1.300 MHz (displayed value of 1.30 MHz) to 1.301 MHz (displayed value 1.30 MHz), and turning the Knob will only allow a maximum displayed value of 1.49 MHz (since the maximum possible deviation is 1.500, not 1.501 MHz).

Partial Preset Does Not Change Increment Set Values

Select PARTIAL (SHIFT INSTR PRESET) to put the instrument in a known state without resetting increment set values.

How Fast You Turn the Knob Affects the Knob Sensitivity

Knob sensitivity changes from fine to coarse when Knob rotation is changed from slow to fast (unless Knob Increment is in use).

HP-IB. Knob Resolution Could Be Useful Via HP-IB

Knob Increment, Knob Hold, and moving the cursor with the cursor positioning keys can be programmed via HP-IB. The programmability of these functions could be useful, for example, when preparing a setup before setting the instrument to local. Physical Knob rotation must be performed from the front panel.

The Meaning of Multiple Cursors

The Knob Hold function and the Knob Increment function can both be useful, but initially might cause some confusion by displaying so many cursors. Knob Hold could cause you to have as many as three cursors in the display at once.

The following summary is listed by quantity of cursors in the display.

One cursor in the display:

1. One cursor over a digit:

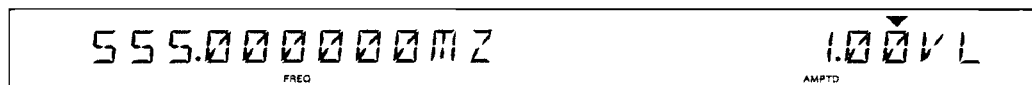

Indicates normal active function status. Also indicates the least-significant digit that will change as you turn the Knob.

Knob (cont'd)

2. One cursor above the first letter of the units specifier:

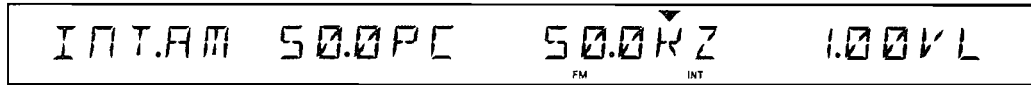

Indicates that the function is the active function and Knob Hold is selected on some other function that is not currently displayed. When you use the Step keys, the value of the displayed function will be stepped (not the Knob "held" function). When you turn the Knob, the "held" function will appear in the display (along with two cursors) and that function's value will change. (The display could resemble a Knob Hold condition when the frequency relative display is less than or equal to -2000 MHz. Refer to "Range of Relative RF Frequency Settings" on page 3-47.)

3. One cursor above the second letter of the units specifier:

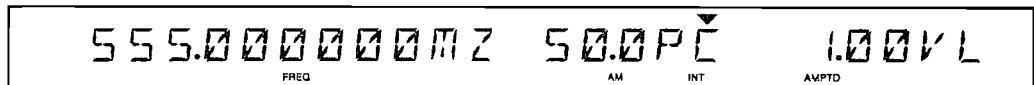

Indicates that the function is the active function and Knob Increment is selected; when you turn the Knob, this function's value will change by the increment set value.

Two cursors in the display:

1. A cursor above a digit and a cursor above the first letter of the units specifier:

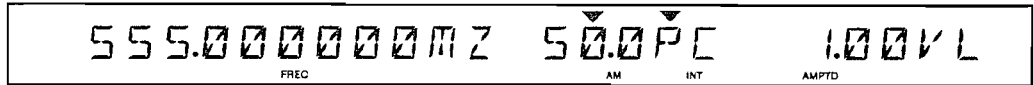

Indicates that Knob Hold is activated over that function; turning the Knob will change the digit under the cursor.

When you press the Step keys or any Data keys (or the Off/On key if applicable), either the displayed function's value will change (if it is also the active function), or the active function will appear in the display and its value will change.

2. A cursor above each letter of the units specifier:

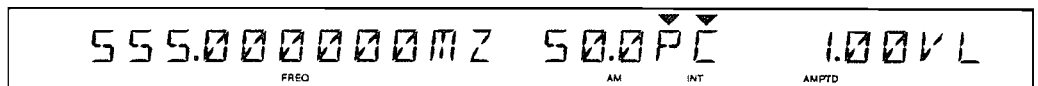

Indicates that both Knob Hold and Knob Increment are activated over that function. When you turn the Knob, that function's value will change by the Increment Set value.

When you press the Step keys or any Data keys (or the Off/On key if applicable), either the displayed function's value will change (if it is also the active function), or the active function will appear in the display and its value will change.

Knob (cont'd)

Three cursors in the display:

1. A cursor above a digit and above the first letter of a units specifier, and a cursor above the first letter of another units specifier:

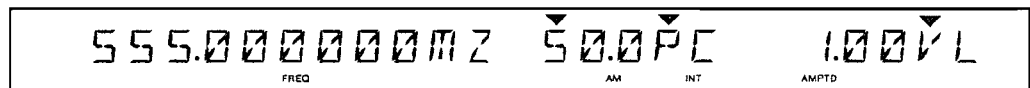

The placement of the two cursors above a function's setting display (the "P" in this case) indicates that Knob Hold is in control over that function; the cursor over this function's value (the "5" in this case) indicates that turning the Knob will change the digit below the cursor. The single cursor above the other function's units specifier (the "V" in this case) indicates it is the active function, and as such, that function's value will change when you press the Step or Data keys (or the Off/On key if applicable).

2. A cursor above each letter of one units specifier, and a cursor above the first letter of another units specifier:

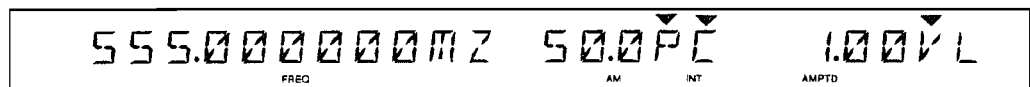

The two cursors over the letters of a particular function's units specifier (AM in this case) indicate that both Knob Hold and Knob Increment are activated over that function. When you turn the Knob, that function's value will change by the Increment Set value. The cursor over the other function's units specifier indicates it is the active function and as such, its value will change when you press the Step or Data keys (or the Off/On key if applicable).

STEP, INCREMENT SET

Description The values of Signal Generator functions can be stepped up or down by an increment set value using the Step keys (or).

The Signal Generator powers up with default increment set values for all functions that allow increment set. (Refer to Table 3-26 below.) You can select a desired increment set value up to the listed maximum. The Signal Generator returns to default increment values if the Power is switched from standby to on or if Instrument Preset is selected.

You can also use the Step keys in the following ways:

- When saving or recalling successive registers. (Refer to **Save/Recall**, page 3-157.)
- When stepping through the Help listing. (Refer to **Special Functions**, page 3-167.)
- When incrementing the phase of the RF frequency using Special Function 250. (Refer to **RF Frequency**, page 3-42.)

Table 3-26. Increment Set Values

Function	Default Increment	Maximum Increment
RF Frequency	10 MHz	2115 MHz
AM Depth	10%	99.9%
FM Deviation	5 kHz	3 MHz
φM Deviation	0.1 radians	200 radians
Modulation Frequency	1 kHz	100 kHz
Modulation Output Level	100 mV	3.3V
Amplitude	1 dB	160 dB (2.24V, 4.49 EMFV)
Start/Stop Amplitude	1 dB	160 dB
Start/Stop Frequency	10 MHz	2115 MHz
Sweep Time	100 ms	999s

Procedures Note: Put the instrument in its initialized state by selecting .

INCR SET

How to Set Increment Size

Select a function, then select , the desired increment set value, and an appropriate units key.



How to Increment a Function

Select the desired function key. Each time you press a Step key, the function's value changes by one step. The Step keys repeat when held down.

If no increment set value has been selected, the Step keys use the default increment set value to change the value of the active function.

Step, Increment Set

How to Display the Increment Value

To display the function's increment size, select the active function's key, then **INCR SET**.

Example

Set a 10 MHz increment set value for RF frequency. Then decrement the 100 MHz RF frequency by 30 MHz.

LOCAL (keys)	ENTRY	DATA	STEP
	FREQ INCR SET	1 0 MHz V	↓ ↓ ↓
HP-IB (program codes)	FRIS 10 MZ FRDN FRDN FRDN		

Display

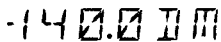
 <small>FREQ</small>	 <small>AMPTD</small>
--	---

The increment value is displayed as it is entered. After the increment set value is entered, the display returns to show the current instrument state. Note the change in frequency value as the step key is pressed. (The digit the cursor is pointing to does not change its value as the Step key is selected. Refer to **Knob**, page 3-141, for information about other ways to change values using the cursor positioning keys.)

HP-IB Codes

Keys	Codes
INCR SET	IS*
Step Down	DN*
Step Up	UP*
*Function should be preceded by an active function code.	

Comments

Considerations When Using Increment Set with Amplitude Settings

If amplitude is displayed in dBm, and increment size is in volts, the amplitude setting will change by the dB equivalent of the voltage increment. Similarly, if amplitude is displayed in volts and the increment setting is in dB, the amplitude setting will change by the voltage-equivalent of the dB increment.

0.001 uV to 2.24V (0.002 EMF uV to 4.49 EMF V) increments can be selected. However, the Signal Generator's setting resolution is limited to the voltage equivalent of 0.1 dB at every output level (except during Linear Amplitude Sweep, Special Function 121).

Step, Increment Set

Undisplayed Digits May Appear to Affect Maximum Settings

You can step in increment set values that will not be displayed when the resolution of the current setting is coarser than the increment set value. (For example, with FM deviation set to 1.30 MHz, an increment change of 1 kHz will not be displayed until 10 increments have been stepped.) Consequently, if at any time you step the displayed setting by that undisplayed increment setting, and then turn the Knob, the Signal Generator may seem to not be able to reach its maximum value. For example, stepping from 1.300 MHz (displayed value of 1.30 MHz) to 1.301 MHz (displayed value 1.30 MHz), and turning the Knob will only allow a maximum displayed value of 1.49 MHz (since the maximum possible deviation is 1.500 MHz, not 1.501 MHz).

How to Put the Increment Set Value on the Knob

Select KNOB INCR (**SHIFT** **→**) to use the Knob to change function values by the increment set values. With Knob Increment, the function's value will change approximately 15 increments per revolution when the Knob is turned. Refer to **Knob**, page 3-142, for more information about putting the increment set value on the Knob using the Knob Increment functions.

Negative Values Are Not Possible with Increment Set

The Signal Generator only accepts positive increment set values. Specifying a negative increment value selects the absolute value of that number.





Related Operating Instructions

Refer to **Instrument Preset, Partial Preset** (page 3-139) for information about setting the instrument to an initialized state that maintains increment set values.



Refer to **Operating Messages** (page 3-177) if the instrument displays a message you want clarified.

ENTRY OFF

Description Entry Off, when selected, can guard against someone accidentally changing the output signal by inadvertently bumping the Knob or pressing a key (for example, while connecting output cables). Entry Off disables the active function as well as the following Signal Generator functions:

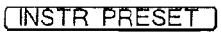

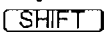
STEP ( and ),
 KNOB, KNOB HOLD, KNOB INCR,
 DATA selection, and
 Cursor positioning ( and ).

Note: Put the instrument in its initialized state by selecting .

Procedure To select the Entry Off function
 ENTRY OFF ( ).

To re-enable the Knob and Step keys, select a function to be active.

Example Disable the Knob, Step keys, etc. to reduce the chance of inadvertently altering the output signal while connecting output cables.

LOCAL (keys)		
 (program codes)	EO	

Display

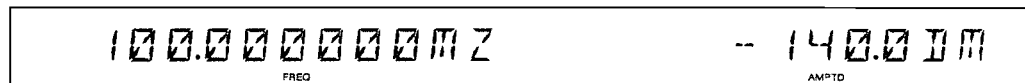

The absence of any cursor (active function indication) over the display settings indicates that settings cannot be changed with the Knob, Step keys, etc.

HP-IB Codes

Keys	Codes
ENTRY OFF	EO

RECALL REGISTERS CONTENTS

<p>Figure 3-17. Functions Related to Recall Registers 3-156</p> <p>SAVE/RECALL 3-157 Table 3-27. Instrument Settings that Cannot Be Saved 3-157</p> <p>SAVE 3-157 How to Save an Instrument State 3-157</p> <p>RECALL 3-159 How to Recall an Instrument State 3-159 HP-IB Codes 3-159</p>	<p>Related Special Functions 3-159 251. Clear Recall Registers 3-159</p> <p>SEQUENCE 3-161</p> <p>SET SEQ 3-161 How to Select a Sequence 3-161</p> <p>SEQ 3-161 How to Step Through the Sequence 3-161 HP-IB Codes 3-162 Comments 3-162</p>
--	---

RECALL REGISTERS

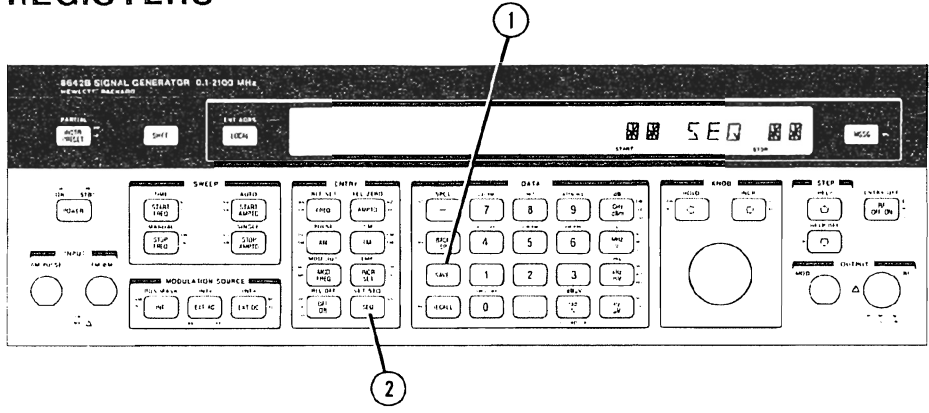

1

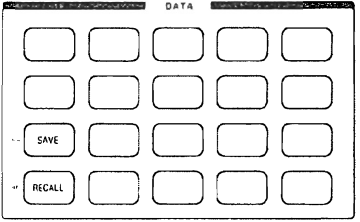

These keys enable you to individually save and recall front-panel settings.

2

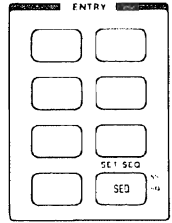

This key enables you to sequentially step through the recall registers.

Figure 3-17. Functions Related to Recall Registers

SAVE/RECALL

Description

Using the Save function, you can save complete instrument states in any of the Signal Generator's 51 recall registers (00 through 50). These registers can then be recalled using the Recall function or the Sequence function. (Refer to **Sequence**, page 3-161.)

The recall registers are stored in RAM (with battery back-up) persisting through Instrument Preset, and switching the Power from standby to on, and unplugging of the ac power cord. However, if RAM memory is ever lost (for example, if the battery loses its charge), all the recall registers will be lost.

Table 3-27 below lists those instrument functions that cannot be saved:

Table 3-27. Instrument Settings that Cannot Be Saved

Messages
HP-IB Address
Local or Remote Mode
Sequence Settings
Special Functions
3. Service Mode
242. Phase Decrement by 1 Degree
243. Phase Increment by 1 Degree
244. Phase Decrement by 5 Degrees
245. Phase Increment by 5 Degrees
248. Single Modulation Frequency Correction
249. Display Firmware Information
250. Phase Adjust on Knob and Steps
251. Clear the Recall Registers

Procedure

Note: Put the instrument in its initialized state by selecting **INSTR PRESET**.

SAVE

How to Save an Instrument State

To save the current instrument state in a specific register:

SAVE followed by the two-digit number of the desired register.

To save the current instrument state in the next available register (for example, to set up instrument states to use with the Sequence function):

SAVE **↑**.

To save the current instrument state in the most recently accessed save/recall register (for example, to re-save an instrument state after recalling and modifying it):

SAVE **↓**.

Save/Recall (cont'd)

Example

First set the Signal Generator's frequency to 10 MHz and set the output amplitude to -10 dBm:

Save this instrument state in register 05.

First:

LOCAL (keys)	DATA
	<input type="text" value="SAVE"/>
 (program codes)	SV

Display

SAVE _ _ OR UP=01 DN=00

Note the UP = 01 and DN = 00 prompts. These show the current register number of (DN = 00) and the next register number (01).

When you enter the register number, the spaces next to the word "SAVE" will be filled.

Select:

When the register number is entered, the display returns to show the current instrument settings.

Now set the output frequency to 500 MHz:

Save this instrument state in the next available register (register 06).

LOCAL (keys)	DATA
	<input type="text" value="SAVE"/> <input type="text" value="↑"/>
 (program codes)	SVUP

After the key is pressed, the display returns to show the current instrument settings.

Save/Recall (cont'd)

RECALL

How to Recall an Instrument State

To recall the instrument state from a specific register:

[RECALL] followed by the two-digit number of the desired register.

To recall the instrument state from the next available register (for example, to recall and modify registers in sequence):

[RECALL] **[↑]**.

To recall the most recently saved or recalled register (for example, to get back to a previous state before it was modified):

[RECALL] **[↓]**

Recalling the last register in this way can get back to a recalled state after modifying settings.

HP-IB

Codes

Keys	Codes
SAVE	SV, SVUP, SVDN
RECALL	RC, RCUP, RCDN

Comments

HP-IB. Exactly two digits must always be used for Save/Recall register numbers.

Editing the Sequence State

If a change is desired in a register that is saved, the **[↓]** key can be used to save the changed instrument state. For example, if, as part of a saved instrument state, an output amplitude of -10 dBm was saved in register 06, this amplitude can be changed to -20 dBm. The following procedure might be used to change the setting in that recall register:

[RECALL] **[0]** **[6]** **[AMPTD]** **[--]** **[2]** **[0]** **[GHZ DBM]** **[SAVE]** **[↓]**.

How Save/Recall Affects the Next Sequence Register Number

Saving a register will not change the next sequence register number. However, recalling a register might change the next sequence register number in the sequence if the recalled register is in the selected sequence.

Recalling an Undefined Register

Recalling a register that is not defined causes messages E93 "RECALL NOT DEFINED .E93" and H10 "RECALL ERROR FOUND .H10". These messages could be caused due to previously executing Special Function 251 (Clear Recall Registers), RAM being lost (for example if the battery lost its charge), or recalling a register before anything is saved in that register.

HP-IB: Executing Error message E93 occurs immediately after recalling an empty register. So by noting the occurrence of E93 (by enabling execution errors to pull SRQ, refer to Service Request on page 3-27 in the HP-IB portion of this Section III), you could find out which register you recalled was not defined.

Related Special Functions

251. Clear Recall Registers. This special function clears all recall registers.

Save/Recall (cont'd)

**Related
Operating
Instructions**

Refer to **Sequence** (page 3-161) for information on sequencing through a sequential group of recall registers.

Refer to **Special Functions** (page 3-165) for information about the way these are accessed.

Refer to **Operating Messages** (page 3-177) if the instrument displays a message you want clarified.

SEQUENCE

Description You can use the Sequence function to select a particular sequence of instrument states saved in recall registers and then step through the sequence. You can also view the next register to be displayed.

The Signal Generator has 51 registers (00 through 50) that can be recalled in sequential order. The selected sequence is kept through Instrument Preset and through Power STBY to ON and unplugging of the ac power cord. However, if RAM memory is ever lost (for example, if the battery loses its charge), the sequence will be lost and the default turn-on sequence setting will be set as start = 00, stop = 50.

Procedure Note: Put the instrument in its initialized state by selecting **INSTR PRESET**.

SET SEQ

How to Select a Sequence

Select the sequence range by first selecting the Set Sequence function and then by entering 2, two-digit register numbers from 00 to 50:
 SET SEQ (**SHIFT** **SEQ**) and the values for the desired range of recall registers.

When the Set Sequence function is selected, the number of the next register is displayed as " NEXT = NN " where NN is the two-digit number of the next register to be recalled in the current sequence.

Only a sequence of increasing register numbers (for example, 10 through 20) can be selected.

SEQ

How to Step Through the Sequence

Just select **SEQ** to step through the selected sequence.

Example

Select a sequence from register 05 through register 15.
 First, select SET SEQ:

LOCAL (keys)	SHIFT	ENTRY SET SEQ SEQ
HP-IB (program codes)	SS	

Display



Sequence (cont'd)

After Set Sequence is selected, the display shows the number of the next register to be recalled. (Note: The display shown above may not match the display on your Signal Generator because this setting is saved through power-down.)

Now select the start register in the register range; the display shows each number as it is entered.

Select .

Display

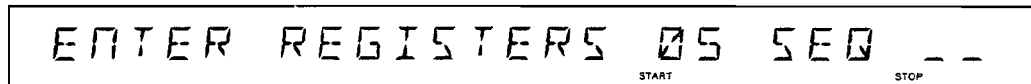

Now select the stop register in the register range:

Select .

After all digits are entered, the display returns to show its current instrument settings.

You can step through the sequence by pressing the key. (If no instrument states are saved in the registers you are sequencing through, an error message will occur indicating that you've recalled an undefined register.)

HP-IB Codes

Keys	Codes
SEQ	SQ
SET SEQ	SS

Comments

HP-IB: Exactly 4 digits must always be used for setting the sequence.

Setting a Start Sequence Greater than the Stop Sequence

If the start register number is greater than the stop register number, the sequence will still increase and "wrap around" to 00 after 50. For example, for a setting from 20 to 15, the registers recalled would be 20, 21, 22, etc., to 50, then 00, 01, etc. to 15.

Selecting a Random Order of Recall Registers

It is not possible to select a random order of recall registers. However, because 51 registers are available, a random order of some recall registers could be resaved in a sequential order in a block of unused registers.

Recalling an Undefined Register

Recalling a register that is not defined causes messages E93 "RECALL NOT DEFINED .E93" and H10 "RECALL ERROR FOUND .H10". These messages could be caused because of a previous execution of Special Function 251 (Clear Recall Registers), RAM being lost (for example if the battery lost its charge), or recalling a register before anything is saved in that register.

HP-IB: Execution Error message E93 occurs immediately after recalling an empty register. So by noting the occurrence of E93 (by enabling execution errors to pull SRQ; refer to **Service Request** on page 3-27 in the HP-IB portion of this Section III), you could find out which register you recalled was not defined.

Sequence (cont'd)

How to Conveniently Modify Recall Registers in the Sequence

SEQ used in conjunction with **SAVE** **↓** can be used to conveniently modify recall registers in the sequence. Just select **SEQ** until the desired register is recalled, then modify the instrument state and re-save it by selecting **SAVE** **↓**.

How to Skip Directly to a Specific Recall Register in the Sequence

You can conveniently skip directly to any recall register in the sequence by just recalling that register directly by register number, then continuing on in the sequence from that register by just selecting **SEQ**.

Related Operating Instructions

Refer to **Save/Recall** (page 3-157) for information on saving instrument settings that you can recall using the Sequence feature.

Refer to **Operating Messages** (page 3-177) if the instrument displays a message you want clarified.

SPECIAL FUNCTIONS CONTENTS

<p>Figure 3-18. Special Function-Related Keys 3-166</p> <p>SPECIAL FUNCTIONS 3-167</p> <p>HELP 3-167</p> <p style="padding-left: 20px;">How to List the Descriptions of Special Functions on the Signal Generator's Display 3-167</p> <p>SPCL 3-168</p> <p style="padding-left: 20px;">How to Select Special Functions 3-168</p> <p>SPCL 2XX 3-169</p> <p style="padding-left: 20px;">How to Turn Off Special Functions 3-169</p>	<p>How to Display the Special Functions</p> <p style="padding-left: 20px;">Currently On 3-169</p> <p>HP-IB Codes 3-169</p> <p>Table 3-28. Summary of Special Functions;</p> <p style="padding-left: 20px;">Function to Code 3-170</p> <p>Summary of Special Functions;</p> <p style="padding-left: 20px;">Code to Function 3-171</p> <p>Detailed Descriptions of All Special Functions 3-172</p>
---	--

SPECIAL FUNCTIONS

1

DATA

2

3

You can select special functions by selecting this key, followed by a valid special function number. (All of the single-digit special functions are labeled in light gray print above digit keys.)

The Help function enables you to display the numbers and descriptions of special functions.

Pressing the Shift key twice can be used to clear the special function description from the display and return the display to showing normal instrument settings.

Figure 3-18. Special Function-Related Keys

SPECIAL FUNCTIONS

Description Special functions enable the Signal Generator's uses to be extended beyond the functions normally available from dedicated front-panel keys.

Some of the more frequently used special functions have an abbreviation printed on the front-panel, in light gray print, above the appropriate Data keys (not to be confused with the HP-IB codes also in light gray print next to most keys).

In this instruction, the special functions are listed in both functional order (page 3-170) and in numeric order (page 3-171). The listing in numeric order provides a brief explanation of each special function. Also, if appropriate, we refer you to a Detailed Operating Instruction which discusses that special function in more detail.

The Help function enables you to view, on the front panel, the code and description of each special function.

Procedures Note: Put the instrument in its initialized state by selecting **INSTR PRESET**.

To turn on any of the special functions, use SPCL (**SHIFT** **-**), followed by the code number of the special function. To list any currently activated special functions, select SPCL (**SHIFT** **-**) alone. To display the number and description of any special function, use HELP (**SHIFT** **↑**) and one of the methods described below.

HELP

How to List the Descriptions of Special Functions on the Signal Generator's Display



HELP (**SHIFT** **↑**) followed by one of the following methods:

- Rotating the Knob.
- Pressing one of the Step keys (**↑** or **↓**).
- Keying in the numeric code of the special function you want described. Special function codes can be keyed in, one right after the other, with no need for re-selecting the Help function. (The SPCL annunciator will not be displayed under the special function description because special functions are being described, not selected)

The Help function can be turned off either by selecting **HELP OFF** (**SHIFT** **↓**) (HP-IB code: HO) or by selecting other Signal Generator functions.

Example

Display the description of Special Function 112.

		STEP	DATA
LOCAL (keys)	SHIFT	HELP 	1 1 2
 (program codes)	HP 112		

Special Functions (cont'd)

Display

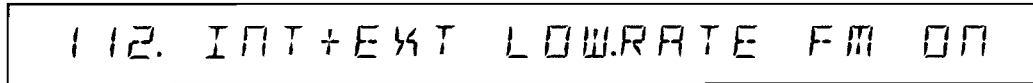

The Signal Generator displays the code and description of Special Function 112. This special function is not turned on with the Help function (note the absence of the SPCL annunciator). Now you can turn the Knob or use the Step keys to view the codes and descriptions of other special descriptions.

SPCL

How to Select Special Functions

SPCL (**SHIFT** **-**) and the desired special function numeric code. (The SPCL annunciator will be displayed below the special function description after the special function is selected.)

Example

Turn on Special Function 9 (Attenuator Range Hold On).

LOCAL (keys)		DATA
	SHIFT	SPCL - 9
HP-IB (program codes)	SP9	

Display

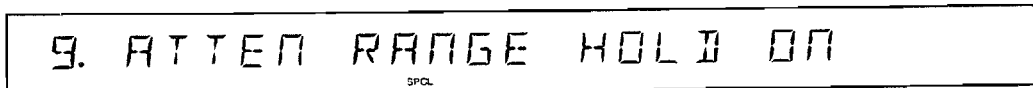

Attenuator Range Hold has been selected. Note the display of the SPCL annunciator. Press the **SHIFT** key twice to return the display to the current instrument state (if desired).

You Can Disable the Automatic Special Description Display

The description that occurs each time a special function is selected can be disabled using Special Function 111 (Disable the Automatic Special Function Verification Display).

Special Functions (cont'd)

SPCL 2XX

How to Turn Off Special Functions

Special functions can be turned off using the following procedures:

- ◆ Turn off a single special function. For example, Special Function 209 (Attenuator Range Hold Off) will turn off Special Function 9 (Attenuator Range Hold On).
Each special function that has a numeric code less than 200 can be disabled using a special function code that is comprised of the number 200 added to the last 2 digits of the special function (or added to the single digit for single-digit special functions). For example, Special Function 4 is disabled with Special Function 204, Special Function 112 is disabled with Special Function 212, etc.
- ◆ Select Special Function 0 (Special Functions 4 through 9 Off) to turn off Special Functions 4 through 9. This is convenient when frequently using just one, single-digit special function (for example Special Function 9).
- ◆ Select Special Function 100 (All Special Function Codes Less Than 200 Off) to turn off Special Functions 4 through 9, 111 through 119, 121 through 123, 134, and 135.
- ◆ Select **INSTR PRESET** (HP-IB IP) or **PARTIAL (SHIFT INSTR PRESET)** (HP-IB: PP).

How to Display the Special Functions Currently On

SPCL (**SHIFT -**)

When SPCL is selected, the codes of the currently selected special functions will be displayed in numeric order. As each special function is selected, it is placed in numeric order in that list.

HP-IB: Use Output Display to read these special functions. (Refer to the discussion about outputting display information which begins on page 3-21 in the HP-IB portion of this Section III.)

RF Frequency can be varied by 0.1 Hz using Special Functions 240 and 241. The status of these is read using the **MSSG** key. Refer to page 3-195, Information Messages I49 through I41 and I51 through I59.

HP-IB Codes

The HP-IB code for special function is SP. When selecting a special function via HP-IB, use the number of the special function preceded by SP (for example, SP4 or SP204). Exactly one or three digits must always be used to select special functions.

Leading zeroes must be suppressed for special functions even though they are required for some other functions (such as SV, RC, and SS).

Keys	Codes
SPCL	SP
HELP	HP
HELP OFF	HO

Related Operating Instructions

Refer to *Operating Messages* (page 3-177) if the instrument displays a message you want clarified.

Special Functions (cont'd)

Table 3-28. Summary of Special Functions; Function to Code

Function	Special Function Description	Code	
		Select	Off
RF Frequency	Prefer Heterodyne Band	8	208
	Decrement Frequency by 0.1 Hz	240	
	Increment Frequency by 0.1 Hz	241	
	Phase Adjust by Knob or Step Keys	250	
	Phase Decrement 1°	242	
	Phase Increment 1°	243	
	Phase Decrement 5°	244	
	Phase Increment 5°	245	
Amplitude	ALC Off	4	204
	Attenuator Range Hold	9	209
	Disable Settling	119	219
AM	Prefer Heterodyne Band	8	208
FM	External Low Rate FM	5	205
	Internal + External Low Rate FM	112	212
	FM Pre-Emphasis	6	206
	Low Distortion FM/φM	7	207
	Negative FM Polarity	115	215
	DC FM Correction Off	116	216
	DC FM Update Mode	117	217
	AC-Coupled DC FM	118	218
	Prefer Heterodyne Band	8	208
	Disable Settling	119	219
φM	Low Distortion FM/φM	7	207
	Negative φM Polarity	114	214
	Prefer Heterodyne Band	8	208
	Disable Settling	119	219
Modulation Oscillator	Modulation Frequency Correction Off	113	213
	Calibrate Modulation Frequency Bands Again	248	
Sweep	Sweep Up and Down	121	221
	Linear Amplitude Sweep	122	222
	Phase Continuous Frequency Sweep	123	223
	Disable Settling	119	219
Miscellaneous	Special Functions 4-9 Off		0
	All Special Functions < 200 Off		100
	Special Function Verification Off	111	211
	Display Firmware Information	249	
	Disable Display	135	235
	Turn Off LCD Lighting	134	234
	Clear Recall Registers	251	
Service	Service Mode (see Service Manual)	3	

Special Functions (cont'd)

Summary of Special Functions; Code to Function

- | | | | |
|------|--------------------------|------|-------------------------|
| 0. | SPCLS 4 - 9 OFF | | |
| 3. | SERVICE MODE. SEE MANUAL | | |
| 4. | ALC OFF | 204. | DISABLE ALC OFF |
| 5. | EXT LOW RATE FM ON | 205. | EXT LOW RATE FM OFF |
| 6. | FM PRE-EMPHASIS ON | 206. | FM PRE-EMPHASIS OFF |
| 7. | LOW DISTORTION FM/PM ON | 207. | LOW DIST FM/PM OFF |
| 8. | PREFER HETERODYNE BAND | 208. | PREFER DIVIDE BANDS |
| 9. | ATTEN RANGE HOLD ON | 209. | ATTEN RANGE HOLD OFF |
| 100. | ALL SPCLS < 200 OFF | | |
| 111. | SPCL FUNC VERIFY OFF | 211. | SPCL FUNC VERIFY ON |
| 112. | INT+EXT LOW RATE FM ON | 212. | INT+EXT LOW RATE FM OFF |
| 113. | MOD.FRQ CORRECTION OFF | 213. | MOD.FRQ CORRECTION ON |
| 114. | NEGATIVE PM POLARITY | 214. | POSITIVE PM POLARITY |
| 115. | NEGATIVE FM POLARITY | 215. | POSITIVE FM POLARITY |
| 116. | DCFM CORRECTION OFF | 216. | DCFM CORRECTION ON |
| 117. | DCFM UPDATE MODE ON | 217. | DCFM UPDATE MODE OFF |
| 118. | AC-COUPLED DCFM ON | 218. | AC-COUPLED DCFM OFF |
| 119. | DISABLE SETTling | 219. | RE-ENABLE SETTling |
| 121. | SWEEP UP AND DOWN ON | 221. | SWEEP UP AND DOWN OFF |
| 122. | LINEAR AMPTD SWEEP | 222. | LOG AMPTD SWEEP |
| 123. | PHASE CONTINUOUS SWP | 223. | PHASE CONT SWEEP OFF |
| 134. | TURN OFF LCD LIGHTING | 234. | TURN ON LCD LIGHTING |
| 135. | DISABLE DISPLAY | 235. | RE-ENABLE DISPLAY |
| 240. | DECR FREQ 0.1 HZ | | |
| 241. | INCR FREQ 0.1 HZ | | |
| 242. | PHASE DECR 1 DEGREE | | |
| 243. | PHASE INCR 1 DEGREE | | |
| 244. | PHASE DECR 5 DEGREES | | |
| 245. | PHASE INCR 5 DEGREES | | |
| 248. | CAL MOD FREQ AGAIN | | |
| 249. | DISPLAY FIRMWARE INFO | | |
| 250. | PHASE ADJ. =KNOB/UP/DN | | |
| 251. | CLEAR RECALL REGS | | |

Special Functions (cont'd)

DETAILED DESCRIPTIONS OF ALL SPECIAL FUNCTIONS

0. Special Functions 4 through 9 Off. This special function turns off Special Functions 4 through 9. (Sometimes all these special functions will not be turned off if the instrument state is dependent on a special function. A message will be displayed to notify you if a special function remained on after you selected Special Function 0.) Special functions can also be turned off individually. (Refer to page 3-169.)

3. Service Mode. See Manual. This special function causes the Signal Generator to enter its service mode. Refer to page 3-201 for information about writing messages to the display, or refer to the Service Manual or the On-Site Manual for information about servicing the instrument. Select any function to exit this mode if this key was accidentally selected.

4. ALC Off. This special function opens the output leveling loop to provide (typically) a 5 dB improvement in third order intermodulation at a 2 kHz offset. Typical output level accuracy is ± 2 dB when ALC Off is selected.

5. External Low Rate FM On

112. Internal + External Low Rate FM On

These special functions typically provide 0.4 Hz to 200 kHz external, ac-coupled FM with the Signal Generator remaining in a phase locked state. Input coupling required for these functions makes the Signal Generator especially sensitive to dc voltage fluctuations. Therefore, relatively small dc voltage changes can cause the Signal Generator to lose phase lock, requiring one to two seconds to regain the locked condition. Special function 5 or 112 is turned off when another FM modulation source is selected.

6. FM Pre-emphasis On. Special Function 6 can be selected to pre-emphasize internal or external FM modulating signals with a 750 us time constant. (Pre-emphasis boosts high frequencies in the modulating signal prior to modulating the carrier.) Refer to **Modulation, FM**, page 3-113.

7. Low Distortion FM/ Φ M On. This special function switches shaper circuitry into the FM/ Φ M loop, reducing total harmonic distortion. Refer to either **Modulation, FM**, page 3-115, or **Modulation, Φ M**, page 3-124.

8. Prefer Heterodyne Band. This special function causes the Signal Generator to operate in the heterodyne band (at RF frequencies below 132.187501 MHz) regardless of FM or Φ M deviation or Phase Continuous Frequency Sweep Span. Refer to **RF Frequency**, page 3-39.

9. Attenuator Range Hold On. When Attenuator Range Hold is selected, the Signal Generator's output attenuators are fixed and the output ALC loop controls signal amplitude. This produces a 30 dB range with monotonic, step-to-step amplitude increments. Refer to **Amplitude**, page 3-74.

100. All Special Function Codes Less than 200: Off. This special function turns off special functions 4 through 9, 111 through 119, 121 through 123, 134, and 135. (Sometimes all these special functions will not be turned off if the instrument state is dependent on a special function. A message will be displayed to notify you if a special function remained on after you selected Special Function 100.) Special functions can also be turned off individually. (Refer to page 3-169.)

111. Disable the Automatic Special Function Verification Display. This special function disables the automatic display of the special function description that normally occurs after each special function is selected.

Special Functions (cont'd)

DETAILED DESCRIPTIONS OF ALL SPECIAL FUNCTIONS (cont'd)

112. Internal + External Low Rate FM On

5. External Low Rate FM On

These special functions typically provide 0.4 Hz to 200 kHz external ac-coupled FM with the Signal Generator remaining in a phase locked state. Input coupling required for these functions makes the Signal Generator especially sensitive to dc voltage fluctuations. Therefore, relatively small dc voltage changes can cause the Signal Generator to lose phase lock, requiring one to two seconds to regain the locked condition. Special functions 112 or 5 is turned off when another FM modulation source is selected.

113. Modulation Frequency Correction Off. This special function disables the single-band calibration of the modulation frequency oscillator that normally occurs whenever the modulation oscillator frequency is set or the internal modulation oscillator is put into use. When this calibration is disabled, the typical modulation frequency switching time is decreased by approximately 200 ms. Refer to **Modulation Frequency**, page 3-133, for a discussion of modulation frequency accuracy with Special Function 113 selected.

114. Negative Φ M Polarity. This special function causes a positive voltage applied to the external FM/ Φ M INPUT to cause a phase lag and a negative voltage applied to cause a phase lead.

115. Negative FM Polarity. This special function causes a positive voltage applied to the external FM/ Φ M INPUT to cause a negative frequency shift and a negative voltage applied to cause a positive frequency shift.

116. DC FM Correction Off. This special function prevents the initial frequency correction that occurs when dc-coupled FM is selected. Normally, when dc-coupled FM is selected, the FM phase lock loop is open, causing an offset in the selected RF output frequency. To correct this initial offset, the dc-coupled signal is momentarily switched off, while an internal counter is used to determine the amount of RF frequency offset. The frequency offset is then corrected, and the dc-coupled signal is switched back on (DC FM Correction). Disabling this correction causes a decrease in switching time by approximately 200 ms.

117. DC FM Update Mode On. With the FM loop unlocked, RF output frequency changes with a change in applied dc signal and with the normal drift of an unlocked VCO that occurs over time and temperature. In the DC FM Update Mode, the Signal Generator measures and displays these RF frequency changes. Refer to **Modulation, FM**, page 3-116.

118. AC-Coupled DC FM On. When the Signal Generator is in the normal ac-coupled FM mode, the external signal is applied to the FM loop through circuitry that uses a phase lock loop to ensure the accuracy of the output signal. In dc-coupled FM (DC FM), the phase lock loop is unlocked and the external signal is applied directly to the unlocked VCO. With Special Function 118 selected, the input signal is ac-coupled to the unlocked FM VCO blocking any applied dc component. (Typical low-frequency corner frequency is 1 Hz) Using DC FM avoids the phase shifts associated with ac-coupled FM circuitry and allows maximum stereo separation. An external dc-coupled FM source must be in use with Special Function 118 to get these benefits.

119. Disable Settling. This special function allows the Signal Generator's microprocessor to respond to new commands without waiting for the internal circuitry to settle, improving response time by up to 40 ms. When using this special function, it's possible to select a function before the previous function has finished settling. Also Special Function 119 disables out-of-lock messages.

Special Functions (cont'd)

DETAILED DESCRIPTIONS OF ALL SPECIAL FUNCTIONS (cont'd)

121. Sweep Up and Down On. Sweep Up and Down is a type of sweep that causes the Signal Generator to sweep from the start end-point to the stop end-point and then from the stop end-point to the start end-point in the same amount of time (during auto or single sweep modes). See Figure 3-7, Sweep Waveforms, in **RF Frequency Sweep**, page 3-66, or Figure 3-10, Sweep Waveforms, in **Amplitude Sweep**, page 3-93.

122. Linear Amplitude Sweep. This special function selects a linearly stepped output rather than the usual logarithmically stepped output. Use a sweep time greater than 900 ms to obtain maximum sweep resolution.

123. Phase Continuous Frequency Sweep. Phase Continuous Frequency Sweep enables the Signal Generator to frequency sweep between two end-points in a linear, phase continuous manner. Refer to **RF Frequency Sweep**, page 3-49.

134. Turn Off LCD Lighting. This special function turns off the LCD back-lighting in the display.

135. Disable Display. Special Function 135 causes the Signal Generator to execute commands without displaying the instrument state (useful in secure environments).

204. Disable ALC Off. This special function re-enables the output leveling loop that was disabled with Special Function 4.

205. External Low Rate FM Off

This special function turns off the FM modulation source selected with Special Function 5. When Special Function 5 is turned off in this way, the Signal Generator selects external, ac-coupled FM.

206. FM Pre-Emphasis Off. This special function turns off the pre-emphasis selected with Special Function 6.

207. Low Distortion FM/ Φ M Off. This special function switches out the shaper circuitry inserted with Special Function 7.

208. Prefer Divide Bands. This special function re-enables the automatic preference of selecting the divide bands over the heterodyne band if possible. This preference is disabled with Special Function 8.

209. Attenuator Range Hold Off. This special function turns off Attenuator Range Hold selected with Special Function 9.

211. Special Function Verify On. This special function re-enables the automatic display of the special function description disabled with Special Function 111.

212. Internal + External Low Rate FM Off. This special function turns off the FM modulation source selected with Special Function 112. When Special Function 112 is turned off this way, the Signal Generator selects internal and external, ac-coupled FM summed together.

213. Modulation Frequency Correction On. This special function re-enables the single-band calibration that normally occurs whenever the modulation oscillator frequency is set or the internal modulation oscillator is put into use. Refer to page 3-173, Special Function 113.

Special Functions (cont'd)

DETAILED DESCRIPTIONS OF ALL SPECIAL FUNCTIONS (cont'd)

214. Positive Φ M Polarity. This special function disables Special Function 114 and re-enables the normally selected phase relationships: A positive voltage applied to the external FM/ Φ M INPUT causes a phase lead and a negative voltage applied causes a phase lag.

215. Positive FM Polarity. This special function disables Special Function 115 and re-enables the normally selected frequency-shift relationships: A positive voltage applied to the external FM/ Φ M INPUT causes a positive frequency shift and a negative voltage applied causes a negative frequency shift.

216. DC FM Correction On. This special function re-enables the correction disabled by Special Function 116.

217. DC FM Update Mode Off. This special function disables the DC FM update that occurs with Special Function 117.

218. AC-Coupled DC FM Off. This special function re-selects the dc coupling to the FM circuitry disabled with Special Function 118.

219. Re-enable Settling. This special function re-enables the settling disabled with Special Function 119.

221. Sweep Up and Down Off. This special function re-enables the normal sweep disabled with Special Function 121. Special Function 221 sets the Signal Generator to repeatedly sweep from the start end-point to the stop end-point (during auto or single sweep modes).

222. Logarithmic Amplitude Sweep. This special function selects the normally selected logarithmic stepped output disabled with Special Function 122.

223. Phase Continuous Frequency Sweep Off. This special function turns off the Phase Continuous Frequency Sweep selected with Special Function 123. Refer to **RF Frequency Sweep**, page 3-49.

234. Turn On LCD Lighting. This special function turns on the LCD lighting disabled with Special Function 134.

235. Re-enable Display. This special function re-enables the display of settings disabled with Special Function 135.

240. Decrement Frequency by 0.1 Hz.

241. Increment Frequency by 0.1 Hz.

These special functions change the RF signal's output frequency in 0.1 Hz steps each time the special function is selected. Changing frequency in these ways cause a message to be queued up in the message list that provides the total increment or decrement. Refer to **RF Frequency**, page 3-42.

242. Phase Decrement 1 Degree

243. Phase Increment 1 Degree

244. Phase Decrement 5 Degrees

245. Phase Increment 5 Degrees

These functions change the RF signal's output phase by the indicated amount each time the special function is selected. For example, selecting SPCL () decrements output phase by 5 degrees

Special Functions (cont'd)

DETAILED DESCRIPTIONS OF ALL SPECIAL FUNCTIONS (cont'd)

248. Calibrate the Modulation Frequency Bands Again. This special function enables you to initiate the calibration sequence that normally only occurs during instrument power up. This function can be used, for example, to recalibrate the modulation oscillator frequency bands if normal modulation frequency correction has been disabled with Special Function 113. Calibration typically takes one to two seconds. Refer to **Modulation Frequency**, page 3-133.

249. Display Firmware Information. This special function displays the current firmware version with a message such as "YYMMDD = FIRMWARE CODE .I3". In this example YYMMDD represents the numbers that will appear in the display where YY is the last two digits of the year, MM is the number of the month, and DD is the day of the month. For example, 841225 would be December 25, 1984.

250. Phase Adjustment from Knob and Step Up and Step Down Keys. This function enables control over the RF signal's output phase in one degree steps using either the Knob or Step keys.

251. Clear Recall Registers. This special function clears all recall registers.

OPERATING MESSAGES CONTENTS

Figure 3-19. Message-Related Keys	3-178	Hardware Error Messages	3-193
OPERATING MESSAGES	3-179	Information Messages	3-194
MSSG	3-180	Prompt Messages	3-196
Queued Up Messages	3-180	Out-of-Lock Messages	3-197
Parameters Changed Messages	3-182	Table 3-29. Out-of-Lock Messages	3-198
Execution Error Messages	3-184		

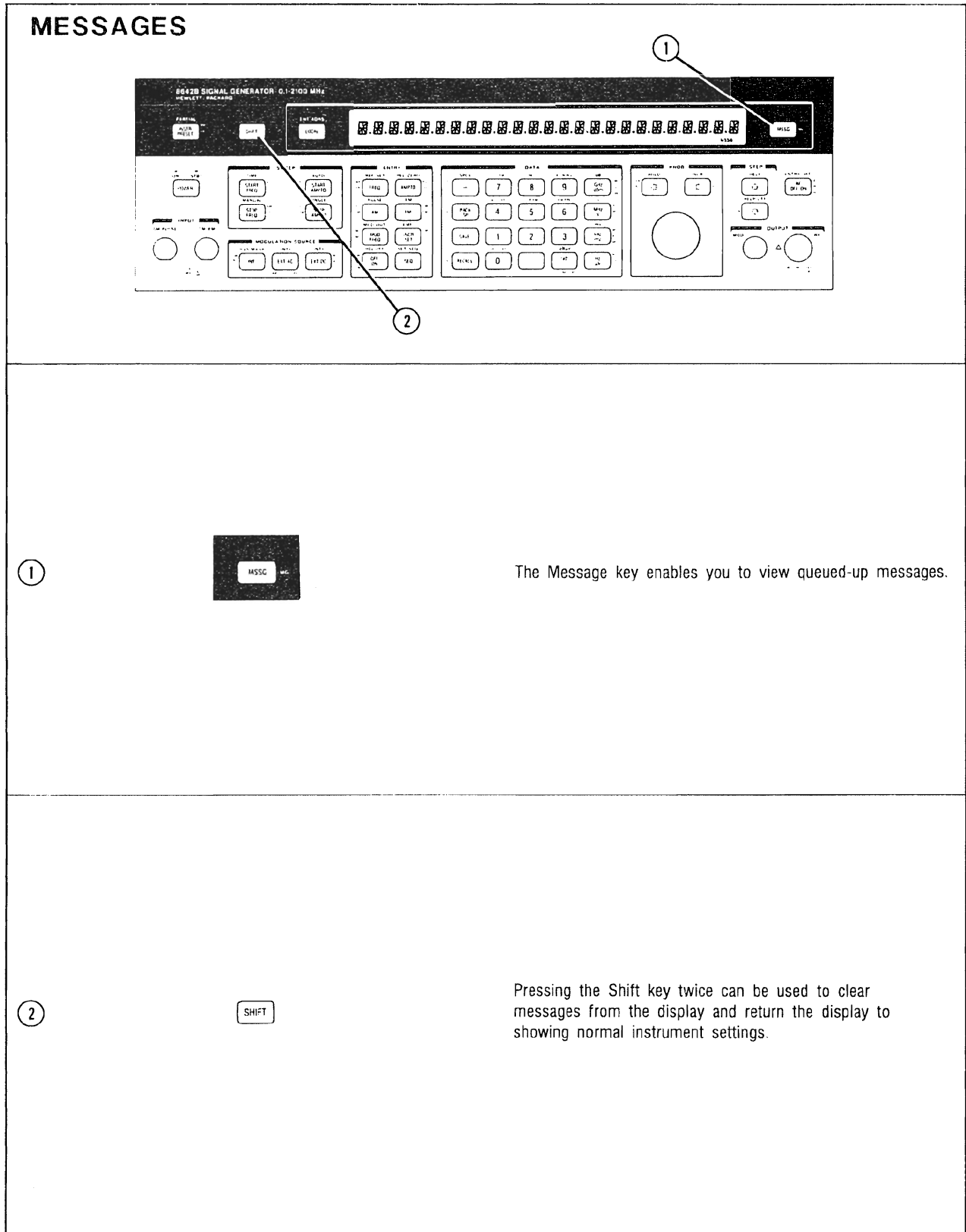

Figure 3-19. Message-Related Keys

OPERATING MESSAGES

Description

The Operating Messages discussed in this instruction are grouped into six categories: Parameters Changed messages (page 3-182), Execution Error messages (page 3-184), Hardware Error messages (page 3-193), Information messages (page 3-194), Prompt messages (3-196), and Out-Of-Lock messages (3-197).

Messages are displayed in a format that shows the wording of the message followed by an alphanumeric code. (Alphanumeric codes combine a letter and a number; for example, C31.) The message listing lists the messages as they are displayed, with the alphanumeric code to the right of the message wording (not to be confused with the message code number in the right margin of the listing). The messages are listed in alphanumeric order.

Refer to either the 8642A/B On-Site Manual or the 8642A/B Service Manual for information regarding Service and Calibration Messages that are not mentioned in this Operating Manual.

Procedure

When Using the Instrument Locally

You will usually be able to view each message whenever the Signal Generator is ready to give you information. That is, you don't need to do anything to the instrument to see a message. However, when you execute some instrument functions, a message is queued up and can be displayed using the **MSSG** key (these messages are noted in the listing). The MSSG annunciator in the right portion of the display notifies you that a message is queued up. To read queued up messages, just select the **MSSG** key repeatedly. When you read "END OF MESSAGE LIST .00" you know there are no more messages in that list.

When Controlling the Instrument via HP-IB

You can access most of the messages using the "OC", "OE", and "OH" commands. (Refer to the discussion about Output Messages, which begins on page 3-16 in the HP-IB portion of this Section III.) Messages accessed this way can be output in the form of a message code number or as an actual alphanumeric message string. In the message listing in this instruction, the message code number that can be output over HP-IB is provided to the far right of the message. If no message code number is provided in the listing, then that message can be read over HP-IB using Output Display (unless otherwise stated), which is described in on page 3-21. If any unique message retrieval procedures exist for a message, they will be described in the individual message description. Also, any message that cannot be read via HP-IB will be noted.

Many of the messages that can be output over HP-IB can be made to initiate a service request. For more information about service requests, refer to **Service Request** on page 3-27 in the HP-IB portion of this Section III.

Operating Messages (cont'd)

HP-IB
Codes

Keys	Codes
MSSG	MG

Comments

MSSG

Queued Up Messages

The instrument is constantly checking its status and updating its current message list appropriately. However, the current message list is different from the copied message list that you can access. The current message list always reflects the current state of messages. However, this list cannot be viewed directly. Only a copied message list can be viewed. You always copy the current list into the copied list to view the queued up messages. (At first reading, this process may sound a bit confusing. Read on for more confusion.)

Some messages are transient and will be cleared from the current list when the condition they reflect no longer exists. (An example is "RECALL ERROR FOUND .H10"). If for some reason you want to re-display such transient messages or handle them via HP-IB, you could read the copied list since the current list would no longer contain that message.

- ◆ To copy the current message list into the copied message list and view the first message:

Select **[MSSG]** (HP-IB: MG) (when the message list is not already being scrolled through with the **[MSSG]** key). At this time, all transient-type messages will be deleted from the current message list. (Note: This could also cause transient hardware and service messages to be deleted from the current message list.)

- ◆ To re-read the copied message list and view the first message:

Select **[SHIFT] [MSSG]** (at any time) to begin scrolling through the copied message list.

- ◆ To continue reading messages, scroll through the copied message list.

Select **[MSSG]** repeatedly until the display of "END OF MESSAGE LIST .00". Selecting **[MSSG]** again brings back the normal display of instrument settings.

For example, let's say that you are not currently viewing the copied message list and the MSSG annunciator is being displayed due to the transient message "RECALL ERROR FOUND .H10" being queued up for display (because sometime in the past you recalled an undefined register). To view that message, you need to copy the current list into the copied list. So you press the **[MSSG]** key (which deletes the transient message from the current message list) and read all the messages. The message you were being signaled to read was a transient message so when you press **[MSSG]** once more after seeing the "END OF MESSAGE .00" message (which brings back the normal display of instrument settings), the MSSG annunciator is no longer displayed. If for some reason you want to re-read that message, you can read the previously copied list by selecting **[SHIFT] [MSSG]**. If you select **[MSSG]** alone, you will lose that message and copy the current message list into the (new) copied list.

The following messages indicate that no messages are queued up or the end of the message list has been reached. To HP-IB users, the following messages indicate that whenever you read back a 0 as a message code number, you know you are finished reading the copied message list.

Operating Messages (cont'd)

NO MESSAGES .00 0

No messages are queued up to be displayed or output over HP-IB. This message is viewed by selecting **MSSG**.

HP-IB: This message may be output with "OH" (or "MG" in combination with Output Display).

NO MESSAGE .00 0

No message is available for output over HP-IB. This message is never displayed locally.

HP-IB: This message may be output with "OC" or "OE".

END OF MESSAGE LIST .00 0

The end of the copied list has been reached. This message is viewed after displaying the entire copied message list (by repeatedly selecting the **MSSG** key).

HP-IB: This message may be output with "OH" (or "MG" in combination with Output Display).

Operating Messages (cont'd)

Parameters Changed Messages

Local: These messages are automatically displayed except for C32 and C33.

HP-IB: All of these messages can be output via HP-IB using "OC".

Parameters Changed messages (message code is prefixed with "C") inform you that the Signal Generator has changed some other setting to allow a new setting. Some of the Signal Generator's functions cannot occur simultaneously with other functions, so the Parameters Changed message indicates the Signal Generator has automatically adjusted or turned off the functions that are preventing the new setting. These messages occur immediately after executing a command that causes some other parameter to automatically change.

HP-IB: You can read only the first Parameters Changed message if more than one has occurred. For example, assume that more than one Parameters Changed message has occurred since either the Status Byte was cleared or since the last time "OC" was executed. Then reading a Parameters Changed message using "OC" will enable you to read out only the first message.

- FR.SWP+PULSE TURNED OFF .C1 2001**
 RF frequency sweep with pulse modulation was turned off. Either **START AMPTD** or **STOP AMPTD** was selected (HP-IB: AA or AB) when RF frequency sweep was on with pulse modulation.
- AMPTD REF SET TO 1.00UV .C2 2002**
 Amplitude reference was set to 1.00 uV. The amplitude reference was set to the dBuV reference (which is 1.00 uV) due to the selection of dBuV (HP-IB: DU). Subsequent amplitude displays will be in dBuV.
- ADJUSTED .002UV RESOL'N .C3 2003**
 Amplitude setting was adjusted to 0.002 uV resolution. In EMF mode, if an attempt is made to set an increment or amplitude reference with an odd number of nanovolts (for example, 0.501, 0.503, 0.505 uV, etc), that value will be adjusted up to an even number of nanovolts.
- INCR+AMPTD REF CHANGED .C4 2004**
 The increment setting and amplitude reference were changed. Changing between EMF and non-EMF amplitude modes could cause the increment and amplitude settings to be reset to allowable values.
- AM TURNED OFF .C11 2011**
 AM was turned off. Either **START AMPTD**, **STOP AMPTD**, or PULSE (**SHIFT** **AM**) was selected (HP-IB codes: AA, AB, or PL) when AM was on. AM is not possible with pulse modulation or amplitude sweep.
- FM TURNED OFF .C12 2012**
 FM was turned off. Φ M was selected when FM was on. FM cannot be done simultaneously with Φ M.
- PHASE MOD TURNED OFF .C13 2013**
 Φ M was turned off. FM was selected when Φ M was on. Φ M cannot be done simultaneously with FM.
- PULSE MOD TURNED OFF .C14 2014**
 Pulse modulation was turned off. Either **START AMPTD**, **STOP AMPTD**, or **AM** was selected (HP-IB codes: AA, AB, or AM) when pulse modulation was on. Pulse modulation is not possible when amplitude sweep or AM are on.

Operating Messages (cont'd)

- SWEEP TIME ADJUSTED** .C21 2021
Sweep time was adjusted to the minimum allowed setting. The sweep time setting was less than the minimum allowed for the type of sweep selected. Either a Stepped Frequency Sweep was set with the sweep time set less than 275 ms, or amplitude sweep was set with the sweep time set less than 20 ms.
- FREQ SWEEP TURNED OFF** .C22 2022
RF frequency sweep was turned off. Either **FREQ**, **START AMPTD**, or **STOP AMPTD** was selected (HP-IB codes: FR, AA, AB) when RF frequency sweep was on.
- FR.SWP+AM TURNED OFF** .C23 2023
RF frequency sweep and AM were turned off. Either **START AMPTD** or **STOP AMPTD** was selected (HP-IB codes: AA, AB) when RF frequency sweep was on with AM.
- AMPTD SWP TURNED OFF** .C31 2031
Amplitude sweep was turned off. One of the following functions was selected when amplitude sweep was on: **START FREQ**, **STOP FREQ**, **AMPTD**, **AM**, or PULSE (**SHIFT** **AM**).
(HP-IB codes: FA, FB, AP, AM, PL).
- AA.OFF...30DB MAX SPAN** .C32 2032
Start amplitude setting was turned off because the new stop amplitude setting was set more than 30 dB away from the start amplitude setting. This message is queued up until it is read (by repeatedly selecting **MSSG**), amplitude sweep is turned off, or the start amplitude is set again.
- AB.OFF...30DB MAX SPAN** .C33 2033
Stop amplitude setting was turned off because the new start amplitude setting was set more than 30 dB away from the stop amplitude setting. This message is queued up until it is read (by repeatedly selecting **MSSG**), amplitude sweep is turned off, or the stop amplitude is set again.
- INCR ADJUSTED** .C41 2041
AMPTD REF ADJUSTED .C42 2042
Increment setting adjusted.
Amplitude reference setting adjusted.
Changing between EMF and non-EMF amplitude modes could cause the increment and/or amplitude settings to be reset to allowable values.

Operating Messages (cont'd)

Execution Error Messages

Local: These messages are automatically displayed.

HP-IB: All of these messages are output via HP-IB using "OE".

Execution Error messages (message code is prefixed with "E") describe the Signal Generator's reason for not executing an attempted setting. Some settings are not possible because functions are coupled together due to limitations of internal circuit configuration. This coupling will sometimes limit the execution of a setting because one function limits the setting of the other. When your setting attempt cannot occur, the Signal Generator explains the restriction. Execution Error messages occur immediately after executing a command that does not execute.

HP-IB: You can read only the first Execution Error message if more than one has occurred. For example, assume that more than one Execution Error message has occurred since either the Status Byte was cleared or since the last time "OE" was executed. Then reading an Execution Error message using "OE" will enable you to read out only the first message.

NEXT STEP NOT POSSIBLE .E1 4001

Next step is not possible. The current setting cannot be stepped up or down (as attempted) with the increment set value. To clear the message without changing instrument settings, select the SHIFT key twice. If you want to read a message that might more specifically describe the setting problem, attempt a data setting similar to the step attempt that caused this error message.

NOT POSSIBLE ABOVE MAX .E2 4002

Not possible above the maximum setting ever allowed. The attempted setting is above the function's maximum possible setting (independent of other functions).

NOT POSSIBLE BELOW MIN .E3 4003

Not possible below the minimum setting ever allowed. The attempted setting is below the function's minimum possible setting (independent of other functions).

SELECT MOD.PREFIX FIRST .E4 4004

Select the type of modulation first. A modulation source was selected when a modulation setting was not displayed. Before selecting the modulation source, select any of the following modulation types: AM, FM, Φ M (SHIFT FM), or PULSE (SHIFT AM).

HP-IB: Specify the modulation type code (AM, FM, PM, or PL) before the modulation source prefix code (NT, XA, XD, BA, or BD).

SELECT SWP.PREFIX FIRST .E5 4005

Select the type of sweep first. A sweep mode (auto, manual, or single) was selected without specifying the sweep type (frequency or amplitude sweep). Select START FREQ, STOP FREQ, START AMPTD, or STOP AMPTD before selecting the sweep mode.

HP-IB: Specify the sweep type code (FA, FB, AA, or AB) before the sweep mode code (SA, SM, or SG).

PLEASE SELECT FUNCTION .E6 4006

Please select an active function. A data value was attempted during manual sweep or when no active function existed. Select a valid function before attempting to enter a data value.

HP-IB: Precede the data entry with a function prefix code.

Operating Messages (cont'd)

- SP6 PREVENTS INT+EXT.FM .E7 4007**
 Special Function 6 (FM Pre-Emphasis On) prevents the selection of a summed internal and external FM source. Select Special Function 206 (FM Pre-Emphasis Off) to select INT+ (EXT AC), INT+ (EXT DC), or Special Function 112 (Internal + External Low Rate FM). Refer to **Modulation, FM** (page 3-113) for more information.
 HP-IB: Select SP206 before selecting FM source codes FMBA, FMBD, or SP112.
- TURN.OFF.SWP.FIRST.SP123 .E8 4008**
 Turn off the frequency sweep before attempting those settings because Special Function 123 (Phase Continuous Frequency Sweep) is the type of frequency sweep currently selected. (Refer to **RF Frequency Sweep**, page 3-49, for more information.) Turn off either **START FREQ** or **STOP FREQ** and then try your setting again.
 HP-IB: Turn off the frequency sweep with FAOF or FBOF, then retry settings.
- SP9+AM LIMIT MAX AMPTD .E9 4009**
 Special Function 9 (Attenuator Range Hold) selected with the current AM setting limits amplitude levels attainable according to Table 3-15 (refer to **Amplitude**, page 3-75). Turn off Attenuator Range Hold (with Special Function 209) and/or reduce AM to a depth that will allow the amplitude setting, or refer to Sequence Dependency which begins on page 3-12 in the HP-IB portion of this Section III.
- FUNCTION OFF. NO STEP .E10 4010**
 The active function is off so its value cannot be stepped. Turn on or set the active function to a valid setting before using the Step keys.
- FUNC DISALLOWS OFF/ON .E11 4011**
 The active function cannot be turned off or on. You attempted to turn off or turn on either **FREQ**, **MOD FREQ**, or sweep TIME (**SHIFT** **START FREQ**) (HP-IB codes FR, MF, or ST). Refer to **Modulation Oscillator**, page 3-131 for a way to effectively turn off the internal modulation oscillator.
- ONLY OFF/ON IS ACTIVE .E12 4012**
 Only the **OFF ON** key can be selected. Select an active function other than PULSE (**SHIFT** **AM**), EMF (**SHIFT** **INCR SET**), or KNOB HOLD (**SHIFT** **←**) before entering data.
 HP-IB: Don't send data immediately after selecting PL, EM, or KH.
- NO ACTIVE FUNCTION .E13 4013**
 Currently no function is active. Select an active function and then try your setting again.
- NOTHING TO BACKSPACE .E14 4014**
 There is no data in the display to backspace. Select an active function before using **BACK SP**.
- NO CURSOR TO MOVE .E15 4015**
 Currently no function is active so no cursor can be moved. Select an active function to activate the Knob before attempting to move cursors.
- INVALID SHIFT FUNC .E16 4016**
 The key you have selected cannot be preceded by the **SHIFT** key. Select a valid shift function.
 HP-IB: Select the proper function code without SH. SH should only be used with the Display Output capability or to get back the normal display of instrument settings (HP-IB code: SHSH). Refer to Output Display information that begins on page 3-21 in the HP-IB portion of this Section III
- INVALID TERMINATOR .E17 4017**
 This message is never displayed locally.
 HP-IB: Invalid terminator received. Send correct terminator code for function you are trying to set.

Operating Messages (cont'd)

- BAD PREFIX RECEIVED .E18 4018**
 A bad prefix has been detected by the Signal Generator. Terminator keys do not have shift functions.
 HP-IB: The Signal Generator received a set of characters that cannot be recognized. Send a valid HP-IB code or use the HP-IB Device Clear command and try again. (Refer to **Clear**, page 3-24, in the HP-IB portion of this Section III.)
- MAXIMUM OF 10 DIGITS .E19 4019**
 This message is never displayed locally.
 HP-IB: The Signal Generator ignored some digits in the entry. Only send 10 digits (including significant leading zeros).
- NUMBER OUT OF RANGE .E20 4020**
 The attempted setting exceeds a numeric value which can be represented internally as a number. Select a value within the Signal Generator's settable range.
- AMPTD LIMITS MAX AM .E24 4024**
 The amplitude setting limits the maximum AM setting. Reduce either the amplitude setting or the attempted AM setting and try again. Refer to Table 3-18 (page 3-102) for information on setting limitations due to amplitude, or refer to the Sequence Dependency discussion that begins on page 3-12 in the HP-IB portion of this Section III.
- AM LIMITS MAX AMPTD .E25 4025**
 The AM setting limits the maximum amplitude setting. Reduce either the AM setting or the attempted amplitude setting and try again. Refer to Table 3-18 (page 3-102) for information on setting limitations due to amplitude, or refer to the Sequence Dependency discussion that begins on page 3-12 in the HP-IB portion of this Section III.
- ONLY INT/EXT.DC PULSE .E26 4026**
 Only an internal or external dc source is possible with pulse modulation. With pulse modulation, select only INT or EXT DC . For other modulation sources, select the modulation type of AM , FM , or Φ M (SHIFT FM) before selecting the modulation source.
 HP-IB: Send only PLNT or PLXD, or ensure codes AM, FM, or PM are sent before XA, BA, or BD.
- PULSE MOD ONLY OFF/ON .E27 4027**
 Pulse modulation can only be off or on. Since pulse modulation can only be turned off or on, knob rotation, cursor positioning keys, and Step keys cannot affect the pulse modulation function.
 HP-IB: Select a function code before UP, DN, KL, or KR.
- AM PREVENTS PULSE MOD .E28 4028**
 AM is not possible with pulse modulation. Turn off AM (HP-IB: AMOF) before selecting pulse modulation.
- PULSE MOD PREVENTS AM .E29 4029**
 Pulse modulation is not possible with AM. Turn off pulse modulation (HP-IB: PLOF) before selecting AM.
- TURN OFF EMF FOR DBM .E30 4030**
 When in the EMF mode, dBm units are not possible. Turn off EMF before selecting dBm amplitude units.
- NO RELATIVE AMPTD SWP .E31 4031**
 Relative values for amplitude sweep cannot be set directly. Convert the desired relative setting value to absolute units, then set the amplitude sweep in absolute units. (Refer to page 3-205 for amplitude units conversion information.) Select only FREQ or AMPTD (HP-IB code FR or AP) before attempting relative settings.

Operating Messages (cont'd)

- NO RELATIVE FREQ SWP .E32 4032**
Relative values for frequency sweep are not possible. Select only **FREQ** or **AMPTD** (HP-IB: FR or AP) before attempting relative settings.
- ONLY FREQ/AMPTD REL .E33 4033**
No relative units are possible with the requested setting. Select only **FREQ** or **AMPTD** (HP-IB: FR or AP) before attempting relative settings.
- AP.REF DISALLOWS DBUV .E34 4034**
An amplitude reference cannot be set in dBuV. Set amplitude to the desired value in dBuV, then select **REL ZERO** (HP-IB: APRZ).
- AP.SWP DISALLOWS DBUV .E35 4035**
An amplitude sweep cannot be directly set in dBuV. Convert the desired dBuV setting value to absolute units, then set the amplitude sweep in absolute units. (Refer to page 3-205 for amplitude units conversion information.)
- FM COUPLED FUNC LIMIT .E38 4038**
FM is coupled with an attempted setting. You are either attempting a setting that is impossible or attempting to set functions in an incorrect order. This message could also have been caused by executing Special Function 0 or 100 when one special function was coupled to other instrument settings. Possibly refer to the Sequence Dependency discussion that begins on page 3-12 in the HP-IB portion of this Section III.
- INT+EXT.FM PREVENT SP6 .E39 4039**
Special Function 6 (FM Pre-Emphasis) cannot be selected when an internal source is summed with an external source. Select a single FM source (**INT** , **EXT AC** , **EXT DC** , or Special Function 5; HP-IB: FMNT, FMXA, FMXD, or SP5) before selecting FM Pre-Emphasis, or refer to the Sequence Dependency discussion that begins on page 3-12 in the HP-IB portion of this Section III.
- PM LIMITS MIN FREQ .E40 4040**
The Φ M setting limits the minimum RF frequency value that can be selected. Either reduce Φ M deviation, or select an RF frequency that allows the Φ M deviation, or refer to the Sequence Dependency discussion that begins on page 3-12 in the HP-IB portion of this Section III.
- PM LIMITS MAX FREQ .E41 4041**
The Φ M setting limits the maximum RF frequency value that can be selected. Either reduce Φ M deviation, or select an RF frequency that allows the Φ M deviation, or refer to the Sequence Dependency discussion that begins on page 3-12 in the HP-IB portion of this Section III.
- FREQ LIMITS MAX PM .E42 4042**
The RF frequency setting limits the maximum value of Φ M deviation that can be selected. Set the RF frequency to a value in a band that allows the desired value of Φ M deviation, or select a Φ M deviation that is allowed at the current RF frequency, or refer to the Sequence Dependency discussion that begins on page 3-12 in the HP-IB portion of this Section III.
- FR.SWP+AUTO LIMITATION .E45 4045**
Stepped Frequency Sweep cannot sweep in the Auto sweep mode under the following conditions:
Setting start and stop end-points if one end-point is less than 4.130860 MHz with a second end-point greater than 132.187500 MHz.
Setting a Stepped Frequency Sweep across 1057.500000 MHz (in the 8642B).
If neither of these restrictions apply to the attempted setting, refer to the Sequence Dependency discussion that begins on page 3-12 in the HP-IB portion of this Section III.

Operating Messages (cont'd)

TURN OFF SWEEP FIRST .E46 4046

Turn off frequency sweep first. To access Special Function 123 (Phase Continuous Frequency Sweep), turn off the start and the stop frequency that was set for the Stepped Frequency Sweep. If this solution does not apply to your attempted setting, refer to the Sequence Dependency discussion that begins on page 3-12 in the HP-IB portion of this Section III.

HP-IB: Send FAOF FBOF before SP123.

FREQ SWP + SP8 LIMIT .E47 4047

Stepped Frequency Sweep cannot sweep in the auto sweep mode across 132.187500 MHz with Special Function 8 (Prefer Heterodyne Band) selected. Either select Special Function 208 (Prefer Divide Bands), or select manual or single sweep, or refer to the Sequence Dependency discussion that begins on page 3-12 in the HP-IB portion of this Section III.

FR.SWP+SP223 LIMIT.TIME .E48 4048

Special Function 223 (Stepped Frequency Sweep) limits the minimum sweep time that can be selected. Either turn off frequency sweep (HP-IB: FAOF FBOF) before setting the sweep time, or refer to the Sequence Dependency discussion that begins on page 3-12 in the HP-IB portion of this Section III.

FREQ.SWP+SWP.TIME LIMIT .E49 4049

The start or stop frequency setting is limited by the currently selected combination of: Phase Continuous Frequency Sweep (Special Function 123), and the current sweep time setting, and possibly the current start and stop frequency settings, and possibly Special Function 8 (Prefer Heterodyne Band) and FM.

To resolve this error, either

- 1) turn off frequency sweep (HP-IB: FAOF FBOF) and then possibly select Stepped Frequency Sweep (Special Function 223), or
- 2) select a valid sweep time setting (refer to **RF Frequency Sweep**, page 3-60), or
- 3) possibly turn off FM or select Special Function 208 (Prefer Divide Bands), or
- 4) refer to the Sequence Dependency discussion that begins on page 3-12 in the HP-IB portion of this Section III.

SP123 LIMITS MIN TIME .E50 4050

The minimum sweep time that can be selected is limited by the currently selected combination of: Phase Continuous Frequency Sweep (Special Function 123), and the current start and stop frequency settings, and possibly Special Function 8 (Prefer Heterodyne Band) and FM.

To resolve this error, either:

- 1) turn off frequency sweep (HP-IB: FAOF or FBOF) and then possibly select Stepped Frequency Sweep (Special Function 223), or
- 2) select a valid sweep time setting (refer to **RF Frequency Sweep**, page 3-60), or
- 3) possibly turn off FM or select Special Function 208 (Prefer Divide Bands), or
- 4) refer to the Sequence Dependency discussion that begins on page 3-12 in the HP-IB portion of this Section III.

SP123 LIMITS MAX TIME .E51 4051

The maximum sweep time that can be selected is limited by the currently selected combination of: Phase Continuous Frequency Sweep (Special Function 123), and the current start and stop frequency settings, and possibly Special Function 8 (Prefer Heterodyne Band) and FM.

To resolve this error, either:

- 1) turn off frequency sweep (HP-IB: FAOF FBOF) and then possibly select Stepped Frequency Sweep (Special Function 223), or

Operating Messages (cont'd)

2) select a valid sweep time setting (refer to **RF Frequency Sweep**, page 3-60), or
 3) possibly turn off FM or select Special Function 208 (Prefer Divide Bands), or
 4) refer to the Sequence Dependency discussion that begins on page 3-12 in the **HP-IB** portion of this Section III.

AP.SWP PREVENTS FR.SWP .E52 4052
 Amplitude sweep and frequency sweep cannot be done simultaneously. Turn off amplitude sweep (**HP-IB**: AAOF ABOF) before attempting frequency sweep.

FM PREVENTS AUTO SWP .E53 4053
 FM during Stepped Frequency Sweep is only possible in manual and single sweep modes. Possibly refer to the Sequence Dependency discussion that begins on page 3-12 in the **HP-IB** portion of this Section III.

AUTO SWP PREVENTS FM .E54 4054
 FM during Stepped Frequency Sweep is only possible in manual and single sweep modes. Possibly refer to the Sequence Dependency discussion that begins on page 3-12 in the **HP-IB** portion of this Section III.

FR.SWP+FM+...LIMIT .E55 4055
 FM is coupled with frequency sweep and one of those settings is limiting the setting of the other. This message could also have been caused by executing Special Function 0 or 100 when one special function was coupled to other instrument settings. Either set FM deviation to a value that is allowed by start and stop frequencies, or set start and stop frequencies to values that allow the FM setting, or refer to the Sequence Dependency discussion that begins on page 3-12 in the **HP-IB** portion of this Section III.

DCFM+SP117+216 LIMIT .E56 4056
 DC-coupled FM, Special Function 117 (DCFM Update Mode), and Special Function 216 (DCFM Correction On) are coupled with Special Function 123 (Phase Continuous Frequency Sweep), and one of those settings is limiting the selection of a frequency sweep. To resolve this error, either:
 1) turn off FM, or
 2) select a non-dc-coupled FM source, or
 3) turn off Special Function 117, or
 4) turn on Special Function 116 (DC FM Correction Off), or
 5) select a combination of those special functions, or
 6) refer to the Sequence Dependency discussion that begins on page 3-12 in the **HP-IB** portion of this Section III.

PM PREVENTS AUTO SWP .E57 4057
 Φ M during Stepped Frequency Sweep is only possible in manual and single sweep modes. Possibly refer to the Sequence Dependency discussion that begins on page 3-12 in the **HP-IB** portion of this Section III.

AUTO SWP PREVENTS PM .E58 4058
 Φ M during Stepped Frequency Sweep is only possible in manual and single sweep modes. Possibly refer to the Sequence Dependency discussion that begins on page 3-12 in the **HP-IB** portion of this Section III.

FREQ SWEEP + PM LIMIT .E59 4059
 Φ M is coupled with frequency sweep and one of those settings is limiting the setting of the other. Either set Φ M deviation to a value that is allowed by start and stop frequencies, or set start and stop frequencies to values that allow the Φ M setting, or refer to the Sequence Dependency discussion that begins on page 3-12 in the **HP-IB** portion of Section III.

Operating Messages (cont'd)

- AMPTD SPAN 30DB MAX .E63 4063**
 An amplitude span of 30 dB is the maximum possible span. Either select an amplitude sweep setting within the 30 dB span limitation or turn off the other amplitude sweep start or stop value (HP-IB: AAOF or ABOF).
- AP.SWP LIMITS MIN TIME .E64 4064**
 The minimum sweep time possible for amplitude sweep is 20 ms. Either select another sweep time or turn off amplitude sweep (HP-IB: AAOF ABOF).
- AP.SWP PREVENTS SP9 .E65 4065**
 Special Function 9 (Attenuator Range Hold) is not possible during amplitude sweep. Turn off amplitude sweep (HP-IB: AAOF ABOF) and set amplitude (HP-IB: AP) before selecting attenuator range hold (HP-IB: SP9).
- SP9 PREVENTS AP.SWP .E66 4066**
 Amplitude sweep is not possible when Special Function 9 (Attenuator Range Hold) is selected. Select Attenuator Range Hold Off (Special Function 209) before selecting amplitude sweep.
- AM PREVENTS AP.SWP .E68 4068**
 Amplitude sweep is not possible when AM is selected. Turn off AM (HP-IB: AMOF) before selecting amplitude sweep.
- AP.SWP PREVENTS AMPTD .E69 4069**
 Output amplitude cannot be set during amplitude sweep. Turn off amplitude sweep (HP-IB: AAOF ABOF) before selecting the output amplitude.
- AMPTD SWP PREVENTS AM .E70 4070**
 AM is not possible during an amplitude sweep. Turn off amplitude sweep (HP-IB: AAOF ABOF) before selecting AM.
- AP.SWP PREVENTS AP.OFF .E71 4071**
 Output amplitude cannot be turned off during amplitude sweep. Turn off the amplitude sweep (HP-IB: AAOF ABOF) before turning off the output amplitude.
- AP.SWP PREVENTS PULSE .E72 4072**
 Pulse modulation is not possible during an amplitude sweep. Turn off the amplitude sweep (HP-IB: AAOF ABOF) before selecting pulse modulation.
- AP.SWP PREVENTS SP4 .E73 4073**
 Special Function 4 (ALC OFF) is not possible during amplitude sweep. Turn off amplitude sweep (HP-IB: AAOF ABOF) before selecting ALC OFF (HP-IB: SP4).
- SP4 PREVENTS AP.SWP .E74 4074**
 Amplitude sweep is not possible when Special Function 4 (ALC OFF) is selected. Select Disable ALC OFF (Special Function 204) before selecting amplitude sweep.
- SP9 LIMITS MIN AMPTD .E75 4075**
 Special Function 9 (Attenuator Range Hold) limits the minimum amplitude that can be selected. To resolve this problem, either
 1) select Attenuator Range Hold Off (Special Function 209), or
 2) select an amplitude within the held amplitude range selected, (refer to Table 3-15, page 3-75, or Figure 3-9, page 3-76), or

Operating Messages (cont'd)

3) refer to the Sequence Dependency discussion that begins on page 3-12 in the HP-IB portion of this Section III.

SP9 LIMITS MAX AMPTD .E76 4076

Special Function 9 (Attenuator Range Hold) limits the maximum amplitude that can be selected. To resolve this problem, either

- 1) select Attenuator Range Hold Off (Special Function 209), or
- 2) select an amplitude within the held amplitude range selected (refer to Table 3-15, page 3-75, or Figure 3-9, page 3-76), or

3) refer to the Sequence Dependency discussion that begins on page 3-12 in the HP-IB portion of this Section III.

AMPTD+SP9 LIMIT MAX.AM .E77 4077

The amplitude selected with Special Function 9 (Attenuator Range Hold) limits the maximum value of AM that can be selected. To resolve this problem, either

- 1) select Attenuator Range Hold Off (Special Function 209), or
- 2) reduce the amplitude setting to get the desired AM setting, or
- 3) select an AM setting allowed with the held range and amplitude setting selected (refer to Table 3-15, page 3-75, or Figure 3-9, page 3-76), or
- 4) refer to the Sequence Dependency discussion that begins on page 3-12 in the HP-IB portion of this Section III.

SP9 PREVENTS PULSE .E78 4078

Pulse modulation is not possible when Special Function 9 (Attenuator Range Hold) is selected. Select Attenuator Range Hold Off (Special Function 209) before selecting pulse modulation.

PULSE PREVENTS SP9 .E79 4079

Special Function 9 (Attenuator Range Hold) is not possible when pulse modulation is selected. Turn off pulse modulation (HP-IB: PLOF) and set output amplitude (HP-IB: AP) to the desired level before selecting attenuator range hold (HP-IB: SP9).

SP9 PREVENTS SP4 .E80 4080

Special Function 4 (ALC Off) is not possible when Special Function 9 (Attenuator Range Hold) is selected. Select Attenuator Range Hold Off (Special Function 209) before selecting ALC off.
HP-IB: Send SP209 before SP4.

SP4 PREVENTS SP9 .E81 4081

Special Function 9 (Attenuator Range Hold) is not possible when Special Function 4 (ALC Off) is selected. Disable ALC Off (Special Function 204) before selecting attenuator range hold.
HP-IB: Send SP204 before SP9.

AM PREVENTS SP4 .E82 4082

Special Function 4 (ALC Off) is not possible when AM is selected. Turn off AM before selecting ALC off.
HP-IB: Send AMOF before SP4.

PULSE PREVENTS SP4 .E83 4083

Special Function 4 (ALC Off) is not possible when pulse modulation is selected. Turn off pulse modulation before selecting ALC off.
HP-IB: Send PLOF before SP4.

Operating Messages (cont'd)

SP4 PREVENTS AM .E84 **4084**
 AM is not possible when Special Function 4 (ALC Off) is selected. Select Disable ALC Off (Special Function 204) before setting AM.
 HP-IB: Send SP204 before AM.

SP4 PREVENTS PULSE .E85 **4085**
 Pulse modulation is not possible when Special Function 4 (ALC Off) is selected. Select Disable ALC Off (Special Function 204) before selecting pulse modulation.
 HP-IB: Send SP204 before PL.

INVALID SPCL FUNCTION .E86 **4086**
 An invalid special function number was selected. Select a special function number that exists. (Refer to **Special Functions**, page 3-171.)

SOME SPCLS STAYED ON .E87 **4087**
 Some special functions remained selected after you selected Special Function 0 or 100 because certain special functions were coupled to other instrument settings. (This message will only occur if more than one special function remains on. Special Function 0 or 100 not turning off just one special function will display a message describing the reason that one special function was not turned off.) View the special functions to see which are still on by selecting SPCL (**SHIFT** **-**) (HP-IB: Use SP and read the display; refer to the Output Display information discussion that begins on page 3-21). The special functions might remain selected because of a sequence dependency problem. Possibly refer to the Sequence Dependency discussion that begins on page 3-12 in the HP-IB portion of this Section III.

0.9 HZ LIMIT REACHED .E88 **4088**
 A maximum RF frequency change of 0.9 Hz can be accumulated using Special Function 240 (Decrement Frequency 0.1 Hz) or Special Function 241 (Increment Frequency 0.1 Hz). To get another 0.1 Hz step, directly set the RF frequency to 1 Hz resolution.

SAVE/RECALL MAX = 50 .E92 **4092**
 The maximum recall register number is 50. Select register numbers only between 00 and 50.

RECALL NOT DEFINED .E93 **4093**
 No instrument settings are saved in this register. The register could have been cleared with Special Function 251 (Clear Recall Registers) or because of a hardware error. This error E93 occurs simultaneously with hardware error H10. Refer to "Recalling an Undefined Register" on page 3-162 for more information.

SEQ NOT SET...4 DIGITS .E94 **4094**
 Sequence was not set, 4 digits are required. Try the sequence setting again using two digits for both the start and stop sequence register numbers.

ADRS VALID 0-30 ONLY .E95 **4095**
 HP-IB addresses are valid only between 0 and 30. Select an HP-IB address between 00 and 30, or select 31 for Listen Only capability.

MASK VALID ONLY 0-255 .E96 **4096**
 The RQS mask is valid only between decimal 0 and 255. Set the RQS mask between those values.

Operating Messages (cont'd)

Hardware Error Messages

Local: These messages are all queued up and can be displayed using the **MSSG** key.

HP-IB: All of these messages are output via HP-IB using "OH". (Some out-of-lock messages are also output using "OH"; refer to page 3-197.)

Hardware Error messages (message number is prefixed with "H") signal the presence of either an internal circuit hardware problem or a firmware problem that you might be able to resolve. Hardware Error messages may occur independently of function execution. A maximum of 20 Hardware Error messages can be queued up to be accessed either by the **MSSG** key on the front panel, or via HP-IB using "OH". If you are unable to repair the hardware error, refer to the Service Manual for more information.

HIT AMPTD=CLEAR RVS.PWR .H1 **7001**
 Press the **AMPTD** key to reset the reverse-power-protect circuitry. A reverse-power condition has been sensed. After this condition is eliminated, select the **AMPTD** key to reset the protection circuitry.
 HP-IB: Send AP after the condition is eliminated. Message H2 will always occur after the reverse-power-protect circuitry is reset in response to message H1.

RVS.PWR PROTECT CLEARED .H2 **7002**
 The reverse-power protect circuitry was previously tripped but is now reset.

RECALL ERROR FOUND .H10 **7010**
 A recall error has been found. This message could be due to a hardware failure (for example, loss of RAM memory). The message means that a recall register that was recalled had no instrument settings saved in it. The register could have been cleared with Special Function 251 (Clear Recall Registers) or because of a hardware error. This error H10 occurs in conjunction with execution error E93. Refer to "Recalling an Undefined Register" on page 3-162 for more information.

MSSG BUFFER OVERFLOWED .H11 **7011**
 The message buffer has overflowed. Some messages were lost.

10MHZ REF. OVEN COLD .H20 **7020**
 The oven for the 10 MHz reference (installed with option 001) is cold. The frequency reference could be unstable until the oven is warm. When the oven cold condition no longer exists, an attempt to scroll through the message list twice will not display the message the second time. (Refer to "Queued Up Messages" on page 3-180 for an explanation of the purpose of scrolling through the message list twice.) Also note that when this message is available, the Knob might not operate in the normal way.

Operating Messages (cont'd)

Information Messages

Local: These messages are automatically displayed when you execute a function.

HP-IB: Most of these messages can be output via HP-IB using the Output Display capability after you execute a function. I1, I2, I59, and I60 cannot be read via HP-IB. To understand a way to read I41 through I49 and I51 through I59, refer to that message description on the following page.

Information messages (message code is prefixed with "I") provide useful information about instrument settings or conditions.

INSTRUMENT PRESET .I1

Instrument Preset is being executed. Refer to **Instrument Preset, Partial Preset**, page 3-138. This message cannot be read via HP-IB using Output Display because it automatically clears from the display after execution completes.

PARTIAL PRESET .I2

Partial Preset is being executed. Refer to **Instrument Preset, Partial Preset**, page 3-139. This message cannot be read via HP-IB using Output Display because it automatically clears from the display after execution completes.

YYMMDD = FIRMWARE CODE .I3

This message is an example of the Signal Generator's display of the current firmware version which is accessed with Special Function 249. In this example, YYMMDD represents the numbers that will appear in the display where YY is the last two digits of the year, MM is the number of the month, and DD is the day of the month. For example, 570218 would be February 18, 1957.

KNOB INCR TURNED OFF .I11

Knob increment mode was turned off. Cursor positioning keys (HP-IB: KL or KR) turn off the Knob Increment mode.

SETTINGS DISPLAY OFF .I21

Special Function 135 (Disable Display) was selected and the display of the instrument settings is disabled. Special Function 235 (Re-enable Display) re-enables the display of instrument settings.

PHASE STEP DOWN 1 DEG .I22

PHASE STEP UP 1 DEG .I23

The RF signal's output phase was stepped down by 1 degree.

The RF signal's output phase was stepped up by 1 degree.

These messages are activated with Special Function 250. Refer to **RF Frequency**, page 3-42.

SPCL FUNC VERIFY OFF .I24

Special Function 111 (Special Function Verify Off) was selected and the automatic Special Function verification is disabled. A special function description will not be displayed automatically whenever a special function is selected. The display of special function descriptions can be re-enabled with Special Function 211.

ENTERING SERVICE MODE .I25

Entering the Service Mode. Special Function 3 was just selected. Either refer to page 3-201 for information about writing messages to the display, or refer to the Service Manual or On-Site Manual for information about using Special Function 3 for servicing the instrument. Select any function to exit this mode.

Operating Messages (cont'd)

SYS CONTROL DISABLED .I31

HP-IB system control capabilities were just disabled. The HP-IB address was just set which disables the Signal Generator's system control capabilities accessed with Special Function 3. (Refer to the Service Manual or On-Site Manual for information about using Special Function 3 for servicing the instrument.)

ADRS=LISTEN ONLY .I32

The instrument is configured as a listen-only device over HP-IB. Refer to **HP-IB Address** (page 3-8) in the HP-IB portion of this Section III.

LISTEN ONLY DISABLED .I33

The instrument is no longer configured as a listen-only device. The instrument's HP-IB address setting was changed from 31 to a value between 00 and 30. Refer to **HP-IB Address** (page 3-8) in the HP-IB portion of this Section III.

WAIT FOR FM LOOP LOCK .I40

Wait for the Signal Generator's internal FM circuitry to complete its setting. This message cannot be read via HP-IB using Output Display because it automatically clears from the display after execution completes. This message is displayed when switching from a dc-coupled FM source to a non-dc-coupled FM source. No additional external settling time allowance is necessary to settle within 100 Hz of the selected frequency.

RF.FREQ=DISPLAY -0.9 HZ	.I49
RF.FREQ=DISPLAY -0.8 HZ	.I48
RF.FREQ=DISPLAY -0.7 HZ	.I47
RF.FREQ=DISPLAY -0.6 HZ	.I46
RF.FREQ=DISPLAY -0.5 HZ	.I45
RF.FREQ=DISPLAY -0.4 HZ	.I44
RF.FREQ=DISPLAY -0.3 HZ	.I43
RF.FREQ=DISPLAY -0.2 HZ	.I42
RF.FREQ=DISPLAY -0.1 HZ	.I41
RF.FREQ=DISPLAY +0.1 HZ	.I51
RF.FREQ=DISPLAY +0.2 HZ	.I52
RF.FREQ=DISPLAY +0.3 HZ	.I53
RF.FREQ=DISPLAY +0.4 HZ	.I54
RF.FREQ=DISPLAY +0.5 HZ	.I55
RF.FREQ=DISPLAY +0.6 HZ	.I56
RF.FREQ=DISPLAY +0.7 HZ	.I57
RF.FREQ=DISPLAY +0.8 HZ	.I58
RF.FREQ=DISPLAY +0.9 HZ	.I59

The current RF output frequency is now summed with one of these 0.1 Hz steps listed in messages I41 through I49 and I51 through I59 that were accessed with either Special Function 240 (Decrement Frequency by 0.1 Hz) or Special Function 241 (Increment Frequency by 0.1 Hz). The RF frequency addition is automatically deleted with any specific frequency setting or change. These messages are queued up and can be displayed using **MSSG**.

HP-IB: Execute "MG" and read the display. Perform this entire process repeatedly to see the RF frequency addition message. Note that reading these messages over the bus (using MG) could cause transient hardware and service messages to be deleted from the message list (refer to Queued Up Messages on page 3-180).

CRUNCH CRUNCH MMMMMMM .I60

Amplitude sweep is possible and is currently being set. This message cannot be read via HP-IB using Output Display because it automatically clears from the display after execution completes.

Operating Messages (cont'd)

Prompt Messages

Local: These messages are automatically displayed when you execute a function.

HP-IB: Most of these messages can be output via HP-IB using the Output Display capability after you execute a function. P91 cannot be read via HP-IB.

Prompt messages (message code is prefixed with "P") instruct you towards completion of the task or function selection you began.

SPCLS OFF. ENTER NUMBER .P0

All special functions are off. To select a special function, select its number.

HIT MSSG FOR EACH MSSG .P1

1501

More than one message is in the message list, select MSSG (HP-IB code: MG) to see each message.

HP-IB: Note that when retrieving a message list using the "OH" command when more than one message exists, this is the first message you will receive in the list. Refer to the Output Messages discussion that begins on page 3-17 in the HP-IB portion of this Section III. For information about re-reading the copied message list, refer to "Queued Up Messages" on page 3-180.

OFF/ON SELECTS EMF ON .P2

The EMF mode is off. Select OFF ON (HP-IB: EMON) to select EMF on.

OFF/ON SELECTS EMF OFF .P3

The EMF mode is on. Select OFF ON (HP-IB: EMOF) to select EMF off.

HIT OFF/ON = HOLD FUNC .P4

Knob Hold is off, to hold the active function on the Knob, select OFF ON.

HP-IB: Send the HP-IB code of the desired active function followed by KHON.

HIT OFF/ON = HOLD OFF .P5

Knob Hold is on, to turn off the Knob Hold function, select OFF ON (HP-IB: KHOF).

USE KNOB/UP/DN/NUMBER .P11

The Help function allows you to view the descriptions and code numbers of special functions. Select either the Knob, Step keys, or a function's number.

RELEASE ALL KEYS .F91

Release all keys. At turn on, it appears that a key is being held down. Release all keys to continue. If a key is not being held down, your instrument may need servicing (refer to the Service Manual). This message cannot be read via HP-IB using Output Display because it automatically clears from the display after the key is released. Also, HP-IB operation is halted when a key is held down with this message displayed.

Operating Messages (cont'd)

Out-of-Lock Messages. The following messages are out-of-lock messages that might appear as queued up messages during operation. (These messages will be disabled if Special Function 119, Disable Settling, is selected.) If any of these messages occur, the instrument might not be functioning properly and need to be serviced. However, some of the messages might be displayed because you have exceeded the instrument's limits. The out-of-lock messages are listed in the Table 3-29, Out-of-Lock Messages on the following page. The solution column provides the number(s) of the solution(s) listed below that might eliminate the out-of-lock condition. **IF THE PRESCRIBED SOLUTION DOES NOT ELIMINATE THE MESSAGE, THE INSTRUMENT SHOULD BE SERVICED.**

Also, these messages can be output using "OH". Refer to the Output Messages discussion that begins on page 3-16 in the **HP-IB** portion of this Section III and to **Hardware Error Messages** on page 3-193.

Solutions

1. Either reduce the amplitude level,
reduce the AM depth, or
reduce the external modulation input level.
2. Either reduce the FM or Φ M deviation,
reduce the modulation frequency,
select Special Function 8 (Prefer Heterodyne Band),
change the external modulation rate, or
change the external modulation level.
3. Either the external reference is not operating properly or
connections are faulty at the rear-panel connector, EXT REF INPUT. (The internal hardware may still be faulty even though the message is gone; that is, the message would appear again if you connected another external reference to the instrument.)

Operating Messages (cont'd)

Table 3-29. Out-of-Lock Messages

Message			Message Code Number	Solution	Comments
A19	OUT OF LOCK ERROR	.D0	3000	1, 2	Doubler ALC loop is out of lock.
A19	TRANSIENT FAILURE	.D1	3001	1, 2	Doubler ALC loop had been out of lock but now appears to be in lock.
A6A2	OUT OF LOCK ERROR	.F0	5000	3	Internal hardware cannot phase lock to the external reference.
A6A2	TRANSIENT FAILURE	.F1	5001	3	Internal hardware had not been able to phase lock to the external reference but now appears to be in lock.
A6A1	OUT OF LOCK ERROR	.F2	5002	2, 3	FM phase lock loop cannot track and lock to the time base.
A6A1	TRANSIENT FAILURE	.F3	5003	2, 3	FM phase lock loop had not been able to track and lock to the time base but now appears to be able to track and lock to the time base.
A13	OUT OF LOCK ERROR	.O0	14000	1, 2	Output Section ALC loop is out of lock.
A13	TRANSIENT FAILURE	.O1	14001	1, 2	Output Section ALC loop had been out of lock but now appears to be in lock.
A11	OUT OF LOCK ERROR	.R0	17000	2, 3	Reference phase lock loop is out of lock.
A11	TRANSIENT FAILURE	.R1	17001	2, 3	Reference phase lock loop had been out of lock but now appears to be in lock.
A12	OUT OF LOCK ERROR	.S0	18000	2, 3	Sum loop is out of lock.
A12	TRANSIENT FAILURE	.S1	18001	2, 3	Sum loop had been out of lock but now appears to be in lock.
A9	OUT OF LOCK ERROR	.T0	19000	3	IF phase lock loop is out of lock.
A9	TRANSIENT FAILURE	.T1	19001	3	IF phase lock loop had been out of lock but now appears to be in lock.
A14	OUT OF LOCK ERROR	.X0	23000	3	Heterodyne module SAW loop is out of lock.
A14	TRANSIENT FAILURE	.X1	23001	3	Heterodyne module SAW loop had been out of lock but now appears to be in lock.
A7	OUT OF LOCK ERROR	.Z0	25000	3	SAW loop is out of lock.
A7	TRANSIENT FAILURE	.Z1	25001	3	SAW loop had been out of lock but now appears to be in lock.

Appendix A: GLOSSARY

absolute units

In the 8642A/B, absolute units are units that can be set directly without using the relative amplitude mode. These include dBm, V, mV, uV, EMF V, EMF mV, and EMF uV.

active function

When a function is active, you do not need to select the function's key before changing its value with either the Knob, or Step or Data keys, or the Off/On key. A function is usually indicated as active when the cursor in the display is above that function's value.

For example, if the cursor is over the RF frequency value, you can enter a new frequency value or use the Knob or Step keys to change the value. You do not need to press the **FREQ** key each time a change is desired.

active function prefix

Many HP-IB codes should not be entered without being prefixed by an active function code. For a list of the active function codes and the codes that should be prefixed with an active function code, refer to Table 3-8, Signal Generator Function to HP-IB Code (page 3-32), or Table 3-9, Signal Generator HP-IB Code to Function (page 3-33).

alphanumeric

The 8642A/B has an alphanumeric display; that is, the display can show both alphabetic and numeric characters.

ASCII

ASCII is an abbreviation for American Standard Code for Information Interchange (pronounced "ask-ee").

cursor

The cursor is the triangular segment above an alphanumeric character in the display. The cursor usually designates the active function and the resolution of the Knob. Cursors also indicate the status of Knob Hold and Knob Increment. Refer to Knob, page 3-141.

divide bands

Divide bands are created when the Signal Generator's frequency range of 528.750001 to 1057.5 is divided down to create its wide RF frequency range. Refer **RF Frequency**, page 3-39.

function

A function refers to each capability of the 8642A/B.

Key functions are labeled directly on the key that accessed the function; frequency (**FREQ**) and amplitude (**AMPTD**) are both key functions.

Shift key functions are labeled in blue above the key that accesses the function (for example, **REF SET** and **REL ZERO**). You can access a shift key function by first pressing the blue **SHIFT** key (which causes the display to show "SHIFT") and then the key under the blue label. (HP-IB: each shift key function has an individual HP-IB code and should not be preceded by a shift code.)

Special functions can be selected by pressing SPCL (**SHIFT** **-**), and then by keying in the code number of the desired special function. Refer to **Special Functions**, page 3-168.

Appendix A: Glossary (cont'd)

heterodyne band

The heterodyne band covers the same frequency range as divide bands 1 through 6, but the heterodyne band allows wider FM and Φ M deviation and wider frequency spans for Phase Continuous Frequency Sweep. Refer to **RF Frequency**, page 3-39

last-selected value

A function's last-selected value usually can be toggled on with the **OFF ON** key.

power up

When the instrument is powered up, it goes through a sequence of internal checks. Refer to **Instrument Preset, Partial Preset**, page 3-137.

queued up

A queued up list is a list of messages that can be accessed when the **MSSG** key is pressed again and again. The MSSG annunciator will indicate when a message is queued up for display. Refer to "Queued Up Messages" on page 3-180.

RQS

RQS (request service) is from the Signal Generator's point of view. The request service (RQS) bit is in the 8642A/B Status Byte. This bit affects when the service request (SRQ) line is pulled on the HP-IB interface. Refer to page 3-27.

scroll

Scrolling through the Help function list lets you view the description and code number of each Special Function. (Refer to the **Special Functions**, page 3-167.) You can scroll through the message list by repeatedly selecting the **MSSG** key.

SRQ

SRQ is from the HP-IB controller's point of view. The service request (SRQ) line is a signal line on the HP-IB interface. This line is pulled low by the Signal Generator when it is requesting service. Refer to page 3-27.

The SRQ annunciator in the display of the 8642A/B indicates that this Signal Generator is pulling the HP-IB SRQ line low.

Appendix B: WRITING MESSAGES TO THE DISPLAY

You can write messages to the Signal Generator's display using service special functions and ASCII character codes. Two, separate, 49-character message strings can be easily displayed on the front panel or read via HP-IB. Messages such as these could be useful, for example, when keeping track of calibration times, or the owner of the instrument, or special calibration information. Also, when testing instruments, a message could be used as a system prompt. These messages are battery-backed up and can be stored through power off, to be read any time.

Service Special Functions 653 through 659 manipulate message 1, Special Functions 663 through 669 manipulate message 2. Note that accessing service special functions is different than accessing the user special functions discussed previously in this manual.

To select user special functions, you key in SPCL (**SHIFT** **-**) and then the special function number. (For HP-IB, use the example on page 3-202.) To select service special functions locally, you need to follow two steps:

- 1) First select user Special Function 3, Service Mode, with keystrokes SPCL (**SHIFT** **-**) **3** . Once you enter the service mode you can access the actual service special functions. However, you can only key in numbers and terminators; selecting any other key will cause the instrument to exit this special mode and display current instrument settings.
- 2) After you enter the service mode, you can select the service special function number. However, the instrument only knows that you have selected a special function when you key in the **HZ UV** terminator. For example, to clear the current message in message 1, you would key in **6** **5** **5** **HZ UV** .

Table 3-30 on page 3-203 lists the special functions that apply to both message 1 and message 2. Table 3-31 on page 3-203 provides a list of valid ASCII character codes. Page 3-204 lists messages that might appear when manipulating the user-defined messages.

Example of Entering a User-Defined Message Via the Front Panel Keys

Select the keys in the example below to write a brief message to the display. Note that if you accidentally select another key and exit the service mode, you will need to re-select Special Function 3 (SPCL, **SHIFT** **-** **3**) in order to continue entering the message.

```

SPCL ( SHIFT - 3 )
6 5 5 HZ UV
6 5 6 7 3 HZ UV
6 5 6 7 6 HZ UV
6 5 6 8 5 HZ UV
6 5 6 8 6 HZ UV
6 5 6 3 2 HZ UV
6 5 6 7 2 HZ UV
6 5 6 8 0 HZ UV
6 5 4 HZ UV

```

Appendix B: Writing Messages to the Display (cont'd)

The following display results from entering the keys from the example on page 3-201:

```

ILUV HP

```

Example of Entering a User-Defined Message Via HP-IB

You can use the following example BASIC program to enter a message string of 49 characters into Message 1. Note that the terminator for each service special function is "EN"; when in the service special function mode, this is the programming equivalent of the local function of pressing the Hz key locally.

```

10 DIM C$ [49]           ! DIMENSION 49 CHARACTER STRING
20 !
30 INPUT C$              ! INPUT CHARACTER STRING FOR MESSAGE 1
40 !
50 OUTPUT 719; "SP3655EN" ! CLEAR MESSAGE 1 IN THE 8642A/B
60 !
70 LET L=LEN (C$)       ! DETERMINE LENGTH OF MESSAGE 1
80 !
90 !
100 FOR I=1 TO L        ! CONVERT EACH CHARACTER IN C$ TO
110 LET A=NUM (C$(I,I)) ! ITS EQUIVALENT ASCII NUMERIC
120 OUTPUT 719 USING 130;A ! CODE
130 IMAGE "SP3656",K,"EN"
140 NEXT I
150 !
160 !
170 OUTPUT 719; "SP3657EN" ! DISPLAY THE MESSAGE
180 !
190 END

```

Example of Reading a User-Defined Message Via HP-IB

You can use the following example BASIC program to read the Message 1 string.

```

10 DIM C$ [49]           ! DIMENSION 49 CHARACTER STRING
20 OUTPUT 719; "SP3657EN" ! DISPLAY MESSAGE 1
30 ENTER 719; C$        ! READ MESSAGE 1
40 END

```

Table 3-30. Special Functions that Can Be Used to Write to the Display

Special Functions		Description
Message 1	Message 2	
653	663	Underline the characters not yet defined in the message.
654	664	Take out the underlines from the characters not yet defined in the message.
655	665	Clear the stored message to enable writing another message.
656	666	Get ready to write the next sequential character in the message. This special function code is followed by the decimal equivalent of an ASCII character.
657	667	Output the message. This code is used to display the first half of the message. This code is also used to output the entire message via HP-IB.
658	668	Backspace to the previous character in the message.
659	669	Output message. This code is used to display the second half of the message.

Table 3-31. ASCII Character Codes

ASCII Character	Decimal Equivalent	ASCII Character	Decimal Equivalent	ASCII Character	Decimal Equivalent
space	32	4	52	H	72
!	33	5	53	I	73
"	34	6	54	J	74
#	35	7	55	K	75
\$	36	8	56	L	76
%	37	9	57	M	77
&	38	:	58	N	78
'	39	;	59	O	79
(40	<	60	P	80
)	41	=	61	Q	81
*	42	>	62	R	82
+	43	?	63	S	83
,	44	@	64	T	84
-	45	A	65	U	85
.	46	B	66	V	86
/	47	C	67	W	87
0	48	D	68	X	88
1	49	E	69	Y	89
2	50	F	70	Z	90
3	51	G	71		

Appendix B: Writing Messages to the Display (cont'd)

Messages

The messages listed below might occur when you are accessing these special functions.

When using the instrument locally you will usually be able to view each message whenever it occurs.

When using the instrument via HP-IB, you can access some messages using the "OE" or "OH" commands. (Refer to **Data Output**, page 3-15, in the HP-IB portion of this Section III.) Messages accessed this way can be output in the form of a message code number or an actual alphanumeric message string. In the following message listing, the message code number that can be output over HP-IB is provided to the far right of the message. If no message code number is provided, then that message can only be read over HP-IB using Output Display (unless otherwise stated), which is also described in **Data Output**. The messages that can be output using "OE" or "OH" can also be made to issue a service request. Refer to **Service Request** (page 3-27) in the HP-IB portion of this Section III for information about service requests.

SPCL 3 ENTRY ERROR .V12

This message occurs if the characters entered were not valid.

ENTER SERVICE CMD .V16

This message occurs if the ASCII code entered was not recognized as valid.

MESSAGE 1 CLEARED .V90

This message occurs when 6 5 5 is selected.

MESSAGE 2 CLEARED .V91

This message occurs when 6 6 5 is selected.

MESSAGE 1 IS FULL .V92 21092

This message might occur after attempting to enter codes into an already full message. This message sets the Execution Error bit in the 8642A/B Status Byte.

MESSAGE 2 IS FULL .V93 21093

This message might occur after attempting to enter codes into an already full message. This message sets the Execution Error bit in the 8642A/B Status Byte.

MESSAGE 1 UNDEFINED .V94 21094

This message might occur when manipulating message 1. The message means that message 1 has not been initialized or RAM memory was lost. To initialize the message, select 6 5 5. This message sets the Hardware Error bit in the 8642A/B Status Byte.

MESSAGE 2 UNDEFINED .V95 21095

This message might occur when manipulating message 2. The message means that message 2 has not been initialized or RAM memory was lost. To initialize the message, select 6 6 5. This message sets the Hardware Error bit in the 8642A/B Status Byte.

COMMENT











If the user-defined message begins with a set of characters resembling the alphanumeric codes used in message displays, the firmware will automatically place those characters at the far right of the display. If this right justification is not desired, put a space character at the beginning of the message.

Appendix C: AMPLITUDE UNITS CONVERSION

You can use this information to convert the output amplitude to practically any desired units. This information might be useful, for example, to convert between dBm and volts or EMF mV and dBm or dB EMF uV to EMF uV.

Observe the following three considerations sequentially when converting amplitude units:

- When you desire non-EMF units and the EMF mode is currently selected, turn off the EMF mode by selecting EMF (**[SHIFT]** **[INCR SET]**) **[OFF ON]** (HP-IB code: EMOF). If you desire EMF units, then do nothing at this point.
- Use the following table to determine the keystrokes or HP-IB codes that will convert to the amplitude units in the left column of the table.

To Select The Following Units:	Select the Following:	
	Keys	HP-IB Codes
dBm ¹	 OR 	VL DM or APRS 0 DM APR0
V, mV, or μ V; or EMF V, EMF mV, or EMF μ V	 or  or 	VL
$\text{dB}\mu\text{V}^2$ or dB EMF μV^2	 OR 	DU or APRS 1 UV
dBf		APRS -120 DM
dBW		APRS 30 DM
dBV dB EMF V		APRS 1 VL
dB mV dB EMF mV		APRS 1 MV
dB REL dB EMF REL	Refer to Relative Amplitude	
¹ If operating below -127.0 dBm, up to a 0.2 dB change could occur. To ensure no level change occurs, use the second sequence provided.		
² To ensure that message "AMPTD REF SET to 1.00UV .C2" will not occur, use the second sequence provided.		

- When you desire EMF units and the EMF mode is currently off, turn on the EMF mode by selecting EMF (**[SHIFT]** **[INCR SET]**) **[OFF ON]** (HP-IB code: EMON).

Appendix C: Amplitude Units Conversion (cont'd)

To convert amplitude values manually, use the following conversion formulas:

dBm	=	dBm
dBf	=	dBm + 120.0
dB V	=	dBm - 13.0
dB mV	=	dBm + 47.0
dB uV	=	dBm + 107.0
dB EMF V	=	dBm - 7.0
dB EMF mV	=	dBm + 53.0
dB EMF uV	=	dBm + 113.0
V	=	$10^{(\text{dBm} - 13.0)/20}$
mV	=	$10^{(\text{dBm} + 47.0)/20}$
uV	=	$10^{(\text{dBm} + 107.0)/20}$
EMF V	=	$10^{(\text{dBm} - 7.0)/20}$
EMF mV	=	$10^{(\text{dBm} + 53.0)/20}$
EMF uV	=	$10^{(\text{dBm} + 113.0)/20}$

Appendix D: DISPLAY ANNUNCIATORS AND ABBREVIATIONS



The front-panel display annunciators usually indicate the state of the Signal Generator; that is, they indicate which functions are currently affecting the output. Each of these annunciators are listed in the order they appear in the display. The explanations below describe the purpose of each annunciator.

RMT, LSTN, TLK, SRQ

These annunciators indicate the HP-IB status of the Signal Generator.

START

The START annunciator in the left portion of the display indicates that RF frequency sweep is selected and a start frequency is currently displayed.

FREQ

This annunciator indicates the RF frequency is being displayed.

REL

The REL annunciator in the left portion of the display indicates the current RF frequency is displayed in relative units.

EMF

When EMF is displayed, amplitude is in EMF units.

SPCL

When SPCL is displayed, a special function is currently selected.

SWPNG

During normal instrument settings display, SWPNG indicates that either an RF frequency or amplitude sweep is currently taking place.

HI, LO

HI and LO can be used to indicate whether the external modulation source level is too high or too low to obtain the displayed depth or deviation.

ΦM, FM, AM

These annunciators can indicate the type or types of modulation selected.

START

When the START annunciator in the left portion of the display appears with the AMPTD annunciator, a start amplitude is currently displayed. When this annunciator appears without the AMPTD annunciator, a sequence is being set.

INT, EXT, AC, DC

Combinations of these annunciators display the current status of the modulation source for the displayed modulation type.

AMPTD

AMPTD indicates that the output amplitude is being displayed.

REL

The REL annunciator in the right portion of the display indicates the current output amplitude is displayed in relative units.

STOP

The STOP annunciator can indicate that the stop frequency of the RF frequency sweep is currently being displayed, or that the stop amplitude of amplitude sweep is currently being displayed, or that sequence is being set.

MSSG

When MSSG is displayed, you can select the Message key to display a queued-up message.

Appendix D: Display Annunciators and Abbreviations (cont'd)

Many abbreviations are used in the display of the 8642A/B. Some of these abbreviations are listed below in alphabetic order. (Abbreviations used in messages that have alphanumeric codes are described in the message list that begins on page 3-182.)

AA	start amplitude
AB	stop amplitude
AM	(AM) amplitude modulation
AP.OFF	amplitude off
DB	dB
DM	dBm
EXT	external modulation source
FM	(FM) frequency modulation
HZ	Hz
INT	internal modulation source
KZ	KHz
MOD.FR.	modulation frequency
MOD.OUT	modulation output level
MR	milliradians
MS	(ms) milliseconds
MV	(mV) millivolts
MZ	MHz
PC	%; percent
PL	pulse modulation
PM	(Φ M) phase modulation
RD	radians
SC	(s) seconds
SEQ	sequence
START.FRQ	start frequency
STOP.FRQ	stop frequency
SW.TIME	sweep time
UR	microradians
UV	(μ V) microvolts
VL	(V) volts

Appendix E: INDIVIDUAL INSTRUMENT IDENTIFICATION

The instrument's model number, serial number, and the options installed in the instrument can be displayed on the front panel or read via HP-IB.

Service Special Function 40 accesses the model number of the instrument, Service Special Function 41 accesses the serial number, and Service Special Function 42 lists the options installed in the instrument. Note that accessing service special functions is different than accessing the user special functions discussed previously in this manual.

To manually select user special functions, you key in SPCL (**SHIFT** **-**) and then the special function number. To manually select service special functions, you need to follow two steps: (For HP-IB, use the HP-IB example below.)

- 1) First select user Special Function 3, Service Mode, with keystrokes SPCL (**SHIFT** **-**) **3**.
- 2) After you enter the service mode, you can select the service special function number followed by the **HZ UV** terminator. (The instrument only knows you have selected a special function when you key in the **HZ UV** terminator.)

To list:

Model number of the instrument: SPCL (**SHIFT** **-**) **3** **4** **0** **HZ UV**

Serial number of the instrument: SPCL (**SHIFT** **-**) **3** **4** **1** **HZ UV**

Options installed in the instrument: SPCL (**SHIFT** **-**) **3** **4** **2** **HZ UV**

HP-IB Example (in BASIC)

The listing below is an example of reading the list of installed options via HP-IB using Output Display (which is described in **Data Output**, page 3-21). Note that the terminator for a service special function is "EN". When in the service special function mode, "EN" is the programming equivalent of manually pressing the Hz key.

```
10 DIM A$(74)
20 OUTPUT 719;"SP342EN"
30 ENTER 719;A$
40 PRINT A$
50 END
```

Comment

Some 8642A instruments will display an Option A02. This is a code for the internal firmware and is not an option that can be ordered.

INDEX

10 MHz OUT, 3-3
10 MHz OVEN OUT, 3-3

A

Abbreviations, in the display, 3-207
AC (see EXT AC), 3-207
Active function, 3-199
AM/PULSE INPUT, 3-99
Amplitude sweep, 3-83
 Display resolution limits in MANUAL, 3-9
 Modulation types not possible during, 3-92
 Relative settings, 3-93
 Step size, 3-83, 3-86
 Zero span, 3-92
Amplitude units conversion, 3-205
Amplitude, 3-69
 Increment set values possible, 3-73
 Overranging, 3-72
 Resolution in dB, 3-73
AMPTD OFF ON, 3-72
AMPTD, 3-70
AM, 3-97
 EXT AC, EXT DC, 3-98
 INT, 3-98
 Maximum settings, 3-102
 Mixed modulation, 3-101
 Modulation restrictions with other functions, 3-101
 Rates increased using heterodyne band, 3-101
Annunciators, in the display, 3-207
Arrow keys, 3-141
ASCII character codes, 3-203
AUTO (sweep mode)
 Amplitude, 3-84
 Frequency, 3-51

B

Basic operation, 3-1
Battery power lost
 HP-IB address, 3-8
 Recall registers, 3-157
 Sequence function, 3-137

C

Calibration messages, 3-179
Converting amplitude units, 3-201, 3-205
Cursor positioning keys, 3-141
Cursors, multiple, 3-145

D

DB, 3-208
DC (see EXT DC), 3-207
Detailed Operating Instructions, 3-35
Display annunciators and abbreviations, 3-207
Divide bands, 3-38, 3-199
DM, 3-208

E

EMF, 3-71
ENT ADRS, 3-8, 3-34
ENTRY OFF, 3-143, 3-153
Errors (see messages), 3-179
EXT AC
 AM, 3-98
 FM, 3-108
 Φ M, 3-121
 Pulse Modulation, 3-128
EXT DC
 AM, 3-98
 FM, 3-108
 Φ M, 3-121
 Pulse Modulation, 3-128
EXT REF INPUT, 3-3

F

Familiarization, 3-1
FM/ Φ M INPUT, 3-103, 3-122
FM, 3-105
 Deviation limits affected by heterodyne band, 3-105
 Deviation limits affected by pre-emphasis, 3-105
 EXT AC, EXT DC, 3-108
 External modulation, 3-110
 Harmonic distortion, 3-115
 INT, 3-107
 Low residual, 3-112
 Maximum stereo separation, 3-112, 3-116
 Mixed modulation, 3-101, 3-124
 Modulation restrictions with other functions, 3-110
 Pre-emphasis, 3-113
FREQ, 3-40
Frequency reference
 Display the, 3-46
 Range of settings, 3-47
 Turn it off, how to, 3-47
Frequency sweep, 3-49
 AUTO sweep setting limitations, 3-51
 Modulation types not possible during, 3-64
 Step size, 3-49, 3-52
 Sweep time, common to all sweeps, 3-64, 3-92
 Sweep time, how to set, 3-52, 3-86
 X-Axis steps, 3-60
 Zero span, 3-65
Frequency, 3-39
 How to set, 3-39, 3-40
 Overranging, 3-42
 Phase adjust, 3-42
 Resolution of 0.1 Hz, 3-42
 Switching time, 3-39
 Underranging, 3-42
FRQ SWEEPING (abbreviation), 3-49
Function, 3-199

G

Glossary, 3-199

H

HELP, 3-167

Heterodyne band, 3-39, 3-200

- Advantages, 3-40
- Affects AM rates, 3-42
- Affects FM deviation, 3-40
- Affects frequency sweep span, 3-40
- Affects Φ M deviation, 3-40
- How to select, 3-41

HI (annunciator), 3-98, 3-108, 3-122

HOLD, 3-143

HP-IB, 3-5

- 8642A/B controller capabilities, 3-31
- Abort, 3-31
- Active function output, 3-18
- Annunciators, 3-31
- Available addresses, 3-8
- Capabilities from the local mode, 3-9
- Capabilities, 3-9
- Capability Reference Table, 3-10
- Clear lockout, 3-26
- Clear, 3-24
- Clearing status bits, 3-24
- Codes, 3-32
- Data entry notation, 3-14
- Data Input Example, 3-11
- Data Input, 3-11
- Data Output, 3-15
- DB and DM, 3-76
- Device Clear (DCL), 3-9
- Display current address, 3-8
- Display indicators, 3-31
- End of sweep, 3-28
- ENT ADRS, 3-8, 3-34
- Entering a user-defined message, 3-202
- Entry notation, 3-14
- Error code recovery, 3-16
- Error, 3-28
- Execution Errors, 3-16
- Front-panel keys, 3-34
- Go To Local (GTL), 3-25
- Hardware Errors, 3-16
- HI, LO status, 3-20
- Input syntax, 3-11
- INT (RQS MASK), 3-34
- Listen address status, 3-9
- Listen only, 3-8
- Local lockout, set local, 3-26
- Local to remote, 3-25
- LOCAL, 3-25, 3-34
- Local/remote, 3-28
- LSTN, 3-11
- MANUAL sweep, 3-64, 3-92
- Message recovery, 3-23
- Messages affected by instrument preset, 3-138
- Messages affected by partial preset, 3-139
- Messages, 3-16, 3-16
- Modulation switching time, 3-132
- OA, 3-18
- OC, 3-16

HP-IB (continued)

- OE, 3-16
- OH, 3-16
- OL, 3-20
- Output active function, 3-18
- Output display information, 3-21
- Output Execution Errors, 3-16
- Output Hardware Errors, 3-16
- Output HI,LO status, 3-20
- Output level switching time, 3-73
- Output messages, 3-16
- Output modulation source, 3-22
- Output Parameters Changed Messages, 3-16
- Output special functions, 3-22
- Parameters Changed Messages, 3-16
- Program codes, 3-32
- Ready, 3-28
- Remote to local, 3-25
- Require Service, 3-27
- Reset status bits, 3-24, 3-30
- RMT, 3-8
- RQS mask affected by instrument preset, 3-138
- RQS mask affected by partial preset, 3-139
- RQS MASK, 3-27, 3-34
- Selected Device Clear (SDC), 3-9
- Sequence dependency, 3-12
- Serial Poll Enable (SPE), 3-29
- Service request, 3-27
- Set address, 3-8
- Set local, 3-26
- SHIFT key, 3-11
- Special functions, 3-169
- SRQ, 3-27
- Status bit clearing, 3-24, 3-30
- Status bit, 3-31
- Status byte affected by instrument preset, 3-138
- Status byte affected by partial preset, 3-139
- Status byte clearing, 3-27, 3-29
- Status byte, 3-29
- Talk address status, 3-9
- TLK, 3-15
- Trigger, 3-31

HZ, 3-208

I

INCR SET, 3-149

INCR, 3-142

Increment set, 3-149

Input data, 3-9

INSTR PRESET, 3-138

Instrument preset, partial preset, 3-137

Internal source (see modulation oscillator), 3-131

INT

- AM, 3-98
- FM, 3-107
- Φ M, 3-120
- Pulse Modulation, 3-127

K

Key functions, 3-35

Knob hold, 3-143

Knob increment, 3-142
 KNOB, 3-141
 KZ, 3-208

L

Learning the 8642A/B, 3-1
 Line fuse, 3-1, 3-3
 LO (annunciator), 3-98, 3-108, 3-122
 LOCAL, 3-25, 3-34
 LSTN (annunciator), 3-207

M

MANUAL sweep from HP-IB, 3-64, 3-92
 MANUAL (sweep mode)
 Amplitude, 3-84
 Frequency, 3-51
 Messages, 3-179
 Detailed list, 3-181
 Queued up, 3-180
 That occur when writing user-defined messages, 3-204
 Transient, 3-180
 User defined, 3-201
 Writing to the display, 3-201
 MOD FREQ, 3-131
 MOD OUT, 3-131
 MOD OUTPUT, 3-131
 MOD OUTPUT, output phase, 3-133
 Modulation frequency (see modulation oscillator), 3-131
 Modulation oscillator, 3-131
 Spurs, 3-133
 Switching time, 3-132
 Underranging, 3-133
 Modulation source, 3-95
 Modulation, AM (see AM), 3-97
 Modulation, FM (see FM), 3-105
 Modulation, Φ M (see Φ M), 3-119
 Modulation, pulse (see Pulse Modulation), 3-127
 MR (abbreviation), 3-208
 MS (abbreviation), 3-208
 MSSG, 3-180
 Multiple cursors, 3-145
 MV (abbreviation), 3-208
 MZ (abbreviation), 3-208

O

OA, 3-18
 OE, 3-16
 OH, 3-16
 Operating messages (see messages), 3-179
 Operator checks, 3-1
 Output data, 3-9
 Output level (also see amplitude), 3-69

P

Partial preset, 3-137
 PARTIAL, 3-139
 PC (abbreviation), 3-208
 Phase continuous frequency sweep, 3-49, 3-64
 DC FM limits, 3-65

Φ M, 3-119
 Deviation limits affected by heterodyne band, 3-119
 EXT AC, EXT DC, 3-121
 INT, 3-120
 Modulation restrictions with other functions, 3-123
 Power-up self check, 3-137
 Bypassing the, 3-139
 POWER, 3-137
 Pre-emphasis, 3-113
 PULSE, 3-127
 Pulse Modulation, 3-127
 Duty cycle, 3-127
 EXT AC, EXT DC, 3-128
 INT, 3-127
 Mixed modulation, 3-130
 Modulation restrictions with other functions, 3-129

R

RD (abbreviation), 3-208
 Recall registers, 3-157, 3-161
 RECALL, 3-159
 Recalling an undefined register, 3-159, 3-162
 REF SET
 Amplitude, 3-78, 3-79
 Frequency, 3-46
 REL OFF
 Amplitude, 3-81
 Frequency, 3-46
 REL ZERO
 Amplitude, 3-77
 Frequency, 3-45
 Relative amplitude, 3-77
 Display the reference, 3-80
 Range of settings, 3-81
 Sweep, how to set, 3-82
 Relative RF frequency (see frequency reference), 3-45
 RF frequency (see frequency), 3-39
 RF frequency sweep (see frequency sweep), 3-49
 RF OFF ON, 3-72
 RF output (see amplitude), 3-69
 RMT, 3-207
 RQS (see SRQ), 3-200
 RQS MASK, 3-27, 3-34

S

Save registers, 3-161
 SAVE, 3-15
 Save/recall, 3-157
 SC (abbreviation), 3-208
 Self calibration, 3-8
 Self test, 3-8
 Self-diagnostics, 3-1
 SEQ, 3-161
 Sequence dependency, 3-12
 Exceptions to flowcharts, 3-14
 Flowcharts of, 3-13
 Function list, 3-13
 How to avoid, 3-12
 Sequence, 3-161
 Service messages, 3-179

SET SEQ, 3-161
 Shift key functions, 3-35
 SINGLE (sweep mode)
 Amplitude, 3-84
 Frequency, 3-51
 SPCL, 3-168
 Special functions, 3-35, 3-167
 0.SPCLS 4-9 OFF, 3-172
 03.SERVICE MODE.SEE MANUAL, 3-172, 3-201
 04.ALC OFF, 3-74
 05.EXT LOW RATE FM ON, 3-112
 06.FM PRE-EMPHASIS ON, 3-113
 07.LOW DISTORTION FM/ ϕ M ON, 3-115, 3-124
 08.PREFER HETERODYNE BAND, 3-41
 09.ATTEN RANGE HOLD ON, 3-74
 100.ALL SPCLS < 200 OFF, 3-172
 111.SPCL FUNC VERIFY OFF, 3-172
 112.INT+EXT LOW RATE FM ON, 3-112
 113.MOD.FRQ CORRECTION OFF, 3-133
 114.NEGATIVE ϕ M POLARITY, 3-124
 115.NEGATIVE FM POLARITY, 3-115
 116.DCFM CORRECTION OFF, 3-116
 117.DCFM UPDATE MODE ON, 3-116
 118.AC-COUPLED DCFM ON, 3-116
 119.DISABLE SETTling, 3-173
 121.SWEEP UP AND DOWN ON, 3-66, 3-93
 122.LINEAR AMPTD SWEEP, 3-94
 123.PHASE CONTINUOUS SWEEP, 3-49
 134.TURN OFF LCD LIGHTING, 3-174
 135.DISABLE DISPLAY, 3-174
 240.DECR FREQ 0.1 HZ, 3-42
 241.INCR FREQ 0.1 HZ, 3-42
 242.PHASE DECR 1 DEGREE, 3-42
 243.PHASE INCR 1 DEGREE, 3-42
 244.PHASE DECR 5 DEGREES, 3-42
 245.PHASE INCR 5 DEGREES, 3-42
 248.CAL MOD FREQ AGAIN, 3-133
 249.DISPLAY FIRMWARE INFO, 3-176
 250.PHASE ADJ.=KNOB/UP/DN, 3-42
 251.CLEAR RECALL REGS, 3-159
 Detailed list, 3-176
 Display current, 3-169

Special functions (continued)
 Select, 3-168
 Summary, 3-170, 3-171
 Turn off, 3-169
 SRQ (see also RQS), 3-200
 SRQ (annunciator), 3-207
 START AMPTD, 3-84
 START FREQ, 3-50
 Step keys, 3-149
 Stereo separation, 3-38, 3-112
 STOP AMPTD, 3-84
 STOP FREQ, 3-50
 Store (see save or recall), 3-159
 SWEEP (abbreviation), 3-83
 SWPNG (annunciator), 3-49, 3-83, 3-207

T

TIME
 Amplitude, 3-85
 Frequency, 3-52
 TLK (annunciator), 3-207

U

Units conversion, 3-205
 UR (abbreviation), 3-208
 User messages, writing to the display, 3-201
 UV (abbreviation), 3-208

V

VL (abbreviation), 3-208

W

Writing messages to the display, 3-201

X

X AXIS output, 3-3, 3-49, 3-65, 3-83, 3-93

Z

Z AXIS output, 3-3, 3-39, 3-65, 3-83, 3-93

PERFORMANCE TESTS

TABLE OF CONTENTS

PROCEDURE TITLE	RECOMMENDED EQUIPMENT
4-1. INTRODUCTION.	
4-2. RECOMMENDED TEST EQUIPMENT.	
4-3. TEST RECORD.	
4-4. ABBREVIATED PERFORMANCE TESTING.	
4-5. LEVEL TESTS. Amplitude Flatness Amplitude Accuracy	HP 8902A, 11722A
4-6. HARMONICS TESTS.	HP 8902A, 11722A
4-7. PULSE TESTS. On/Off Ratio	HP 8902A, 11722A
4-8. RESIDUALS TEST. Residual AM Residual FM	HP 8902A, 11722A
4-9. AM, FM, AND PM TESTS. AM Accuracy Incidental PM AM Distortion PM Accuracy and Distortion DC FM Center Frequency Accuracy FM Accuracy Incidental AM FM Distortion (1kHz)	HP 8902A, 11722A
4-10. EXTENDED FM DISTORTION TEST 20 Hz TO 100 kHz	HP 8902A, 11722A, 8903A
4-11. INTERNAL MODULATION OSCILLATOR TESTS. Distortion Level Accuracy Frequency Accuracy Output Impedance	HP 8903A, 11095A
4-12. SWR TEST.	HP 8902A, 11722A, 8642B, SWR BRIDGE 11512A
4-13. SPURIOUS TEST.	8566A/B

PERFORMANCE TESTS

TABLE OF CONTENTS

PROCEDURE TITLE	RECOMMENDED EQUIPMENT
4-14. 3RD ORDER INTERMODULATION TEST.	HP 8566A/B, 8642B, 11514A, 8491A OPT 006
4-15. PHASE NOISE TEST.	HP 8566A/B, 1980B, 11514A, 08640-60506, 1 MHz LPF
4-16. OPTIONAL PHASE NOISE TEST.	HP 8566A/B, 8642B, 1980B, 11514A, 08640-60506, 1 MHz LPF
4-17. EXTENDED PULSE TESTS. Rise Time Maximum Rate On/Off Ratio	HP 8116A, 8566A/B, 1980B
4-18. OPTIONAL RESIDUAL FM TEST	HP 8902A, 11722A, 8662A
4-19. OPTION 001 FREQUENCY AGING RATE	FREQ. STD., 1980B

PERFORMANCE TESTS

4-1. INTRODUCTION

The procedures in this section test the instrument's electrical performance using the specifications from Table 1-1 as the performance standards. All tests can be performed without access to the interior of the instrument. Data points are given both for the 8642A and the 8642B; when testing an 8642A delete the data points that apply only to the 8642B. In general, these are the specifications for RF frequencies greater than 1057.5 MHz unless otherwise noted.

NOTES

If the performance tests are to be valid the following conditions must be met:

- a. *The HP 8642 must have a 30 minute warmup.*
- b. *The mains (line) voltage must be within +5-10% of 100, 110, 220 or 240 volts rms AC at 47.5 - 440 Hz.*
- c. *The ambient temperature must be 0 to +55 degrees C.*
- d. *Before aging rate tests are performed, the HP 8642 must have a 8 day warmup if it has been disconnected from the Mains power for more than 24 hours, or if the HP 8642 has been disconnected from the Mains power for less than 24 hours it must have a 24 hour warmup.*

4-2. RECOMMENDED TEST EQUIPMENT

Equipment required for the performance tests is listed in the Recommended Test Equipment table in Section I. Any equipment that satisfies the critical specifications given in the table may be substituted for the recommended model(s).

4-3. TEST RECORD

Results of the performance tests may be tabulated in the Test Record at the end of the procedures. The Test Record lists all of the tested specifications and their acceptable limits. The results recorded at incoming inspection can be used for comparison in periodic maintenance and troubleshooting and after repairs or adjustments.

PERFORMANCE TESTS

4-4. ABBREVIATED PERFORMANCE TESTING

Limited Calibration:

Limited Calibration is a service offered by the Hewlett-Packard Company Service Centers that involves on-site performance testing of the HP 8642 Synthesized Signal Generator. It is a sub-set of the full Performance Tests in this section.

Self Test:

At power up the HP 8642 internal controller executes a 20 second operational check, which is termed Self Test. The Self Test quickly evaluates the correctness of operation and provides the operator with a 90% assurance that the HP 8642 is fully operational.

There is also an instrument level self test that evaluates the correctness of operation and provides the operator with an 80% assurance that the HP 8642 is operating within its specifications. Refer to the **INSTRUMENT LEVEL SELF TEST** under the **DIAGNOSTIC** tab in Section VIII.

Post-Repair Performance Testing:

When the HP 8642 Module Exchange philosophy of repair is utilized by the customer, Performance Testing is not required. Exchange modules are tested to levels of performance specified to insure HP 8642 warranted performance and calibration. Refer to the diagnostics tab in Section VIII for Module Replacement procedures.

PERFORMANCE TESTS

Table 4-2. Recommended Performance Tests and Adjustments After Repairs.
(This does not apply when module exchange is the method of repair.)

PERFORMANCE TESTS

4-5. LEVEL ACCURACY AND FLATNESS TESTS

SPECIFICATION:

Electrical Characteristics	Performance Limits	Conditions
OUTPUT		
Level Range (8642B)	+20 dBm to -140 dBm +19 dBm to -140 dBm +18 dBm to -140 dBm +17 dBm to -140 dBm +16 dBm to -140 dBm	band 1-7 8 HET 9 10
Level Range (8642A)	+20 dBm to -140 dBm +18 dBm to -140 dBm +16 dBm to -140 dBm	band 1-7 8, HET 9
Resolution	0.1 dB	
Absolute Level Accuracy ¹	+1.0 dB	>-127 dBm
Flatness	<±0.75 dB	+10 dBm

¹Includes detector linearity, temperature, flatness, and attenuator accuracy.

DESCRIPTION: Level accuracy and flatness are checked at levels that can be read accurately by a measuring receiver.

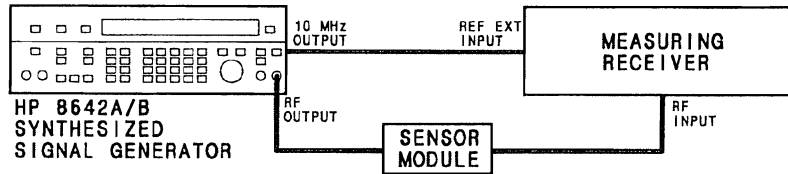

Figure 4-1. Level Accuracy and Flatness Test Setup

EQUIPMENT: Measuring Receiver HP 8902A
 Sensor Module HP 11722A

PERFORMANCE TESTS

PROCEDURE: 1. Be sure that the calibration numbers from the power sensor module have been entered into the measuring receiver and that the measuring receiver is zeroed¹ and calibrated in RF Power mode.

2. RF Flatness

Connect the instruments as shown in Figure 4-1.

Set up the HP 8642 as follows:

INSTRUMENT PRESET
AMPLITUDE +10.0 dBm

Set up the measuring receiver as follows:

INSTRUMENT PRESET
MEASUREMENT MODERF POWER
DISPLAY LOG (dBm)

3. Set the RF frequency of the HP 8642 and the measuring receiver to those listed in the following table.

8642 FREQ, Measuring Receiver Frequency (MHz)	Results (dBm)
0.1	_____
0.3	_____
1.0	_____
3.0	_____
10.0	_____
30.0	_____
100.0	_____
200.0	_____
300.0	_____
400.0	_____
500.0	_____
600.0	_____
700.0	_____
800.0	_____
900.0	_____
1000.0	_____
2000.0	_____

¹ If the measuring receiver is an HP 8902, refer to the HP 8902 Operating Information Pull-out Card.

PERFORMANCE TESTS

4. In the readings taken above identify the maximum (P_{\max}) and minimum (P_{\min}) power levels. Compute the worst case flatness error using the formula below. The value must be less than 0.75 dB.

$$\frac{(P_{\max}) - (P_{\min})}{2} = \text{_____ dB}$$

5. HET Band Level Accuracy

On the HP 8642 key in SPCL 8 to enable the HET Band. Change the measuring receiver display to linear. Set the HP 8642 and measuring receiver to 0.1 MHz. Set the HP 8642 to the amplitude levels given in the table below and verify that the readings are within the given limits.

Band	8642 AMPTD (dBm)	Results (watts)		
		Min.	Actual	Max.
HET	+18	50.12E-03	_____	79.43E-03
	+9.9	7.762E-03	_____	12.30E-03
	+5	2.510E-03	_____	3.981E-03
	0	794.3E-06	_____	1.259E-03
	-10	79.43E-06	_____	125.9E-06
	-20	7.943E-06	_____	12.59E-06

6. Level Accuracy.

On the HP 8642 key in SPCL 0 to disable the HET band. Set the HP 8642 and the measuring receiver to the values given in the table below. At all 0 dBm amplitude settings, change measuring receiver measurement mode to Tuned RF, and on the HP 8642 key in INCR SET, 10 dBm. This will enable the step function to be used (see Operating Fundamentals). Also, if measuring receiver is an HP 8902A, return to 0 dBm at the end of each band and store instrument configuration as instructed in notes 2 through 7. Verify that the power readings on the measuring receiver are within the specified limits.

PERFORMANCE TESTS

Band	HP 8642 AMPTD (dBm)	8642 FREQ (MHz)	Measuring Receiver Frequency (MHz)	Measuring Receiver Mode	Results (watts)		
					Min.	Actual	Max.
1	+20	3	3	RF POWER	79.43E-03	_____	125.9E-03
	+9.9	3	3	RF POWER	7.762E-03	_____	12.30E-03
	+5	3	3	RF POWER	2.510E-03	_____	3.981E-03
1	0 ¹	3	3	TUNED RF	0.794E-06	_____	1.259E-03
	-10	3	3	TUNED RF	79.43E-06	_____	125.9E-06
	-20	3	3	TUNED RF	7.943E-06	_____	12.59E-06
	-30	3	3	TUNED RF	794.3E-09	_____	1.259E-06
	-40 ¹	3	3	TUNED RF	79.43E-09	_____	125.9E-09
	-50	3	3	TUNED RF	7.943E-09	_____	12.59E-09
	-60	3	3	TUNED RF	794.3E-12	_____	1.259E-09
	-70	3	3	TUNED RF	79.43E-12	_____	125.9E-12
	-80 ¹	3	3	TUNED RF	7.943E-12	_____	12.59E-12
	-90	3	3	TUNED RF	794.3E-15	_____	1.259E-12
	-100	3	3	TUNED RF	79.43E-15	_____	125.9E-15
	-110	3	3	TUNED RF	7.943E-15	_____	12.59E-15
	-120	3	3	TUNED RF	794.3E-18	_____	1.259E-15
	-127	3	3	TUNED RF	158.5E-18	_____	251.2E-18
	0 ²	3	3	TUNED RF	---	_____	---
3	+20	10	10	RF POWER	79.43E-03	_____	125.9E-03
	+9.9	10	10	RF POWER	7.762E-03	_____	12.30E-03
	+5	10	10	RF POWER	2.510E-03	_____	3.981E-03
3	0 ¹	10	10	TUNED RF	794.3E-06	_____	1.259E-03
	-10	10	10	TUNED RF	79.43E-06	_____	125.9E-06
	-20	10	10	TUNED RF	7.943E-06	_____	12.59E-06
	-30	10	10	TUNED RF	794.3E-09	_____	1.259E-06
	-40 ¹	10	10	TUNED RF	79.43E-09	_____	125.9E-09
	-50	10	10	TUNED RF	7.943E-09	_____	12.59E-09
	-60	10	10	TUNED RF	794.3E-12	_____	1.259E-09
	-70	10	10	TUNED RF	79.43E-12	_____	125.9E-12
	-80 ¹	10	10	TUNED RF	7.943E-12	_____	12.59E-12
	-90	10	10	TUNED RF	794.3E-15	_____	1.259E-12
	-100	10	10	TUNED RF	79.43E-15	_____	125.9E-15
	-110	10	10	TUNED RF	7.943E-15	_____	12.59E-15
	-120	10	10	TUNED RF	794.3E-18	_____	1.259E-15
	-127	10	10	TUNED RF	158.5E-18	_____	251.2E-18
	0 ³	10	10	TUNED RF	---	_____	---

¹ On the HP 8902A Measuring Receiver press CALIBRATE before continuing test.

^{2, 3} On the HP 8902A Measuring Receiver, press blue SHIFT, STORE, followed by the numeric key indicated by the note number.

PERFORMANCE TESTS

Band	HP 8642 AMPTD (dBm)	8642 FREQ (MHz)	Measuring Receiver Frequency (MHz)	Measuring Receiver Mode	Results (watts)		
					Min.	Actual	Max.
6	+20	100	100	RF POWER	79.43E-03	_____	125.9E-03
	+9.9	100	100	RF POWER	7.762E-03	_____	12.30E-03
	+5	100	100	RF POWER	2.510E-03	_____	3.981E-03
6	0 ¹	100	100	TUNED RF	794.3E-06	_____	1.259E-03
	-10	100	100	TUNED RF	79.43E-06	_____	125.9E-06
	-20	100	100	TUNED RF	7.943E-06	_____	12.59E-06
	-30	100	100	TUNED RF	794.3E-09	_____	1.259E-06
	-40 ¹	100	100	TUNED RF	79.43E-09	_____	125.9E-09
	-50	100	100	TUNED RF	7.943E-09	_____	12.59E-09
	-60	100	100	TUNED RF	794.3E-12	_____	1.259E-09
	-70	100	100	TUNED RF	79.43E-12	_____	125.9E-12
	-80 ¹	100	100	TUNED RF	7.943E-12	_____	12.59E-12
	-90	100	100	TUNED RF	794.3E-15	_____	1.259E-12
	-100	100	100	TUNED RF	79.43E-15	_____	125.9E-15
	-110	100	100	TUNED RF	7.943E-15	_____	12.59E-15
	-120	100	100	TUNED RF	794.3E-18	_____	1.259E-15
	-127	100	100	TUNED RF	158.5E-18	_____	251.2E-18
0 ⁴	100	100	TUNED RF	_____	_____	_____	
8	+19 ⁸	500	500	RF POWER	63.09E-03	_____	100.0E-03
	+18 ⁹	500	500	RF POWER	50.12E-03	_____	79.43E-03
	+9.9	500	500	RF POWER	7.762E-03	_____	12.30E-03
	+5	500	500	RF POWER	2.510E-03	_____	3.981E-03
8	0 ¹	500	500	TUNED RF	794.3E-06	_____	1.259E-03
	-10	500	500	TUNED RF	79.43E-06	_____	125.9E-06
	-20	500	500	TUNED RF	7.943E-06	_____	12.59E-06
	-30	500	500	TUNED RF	794.3E-09	_____	1.259E-06
	-40 ¹	500	500	TUNED RF	79.43E-09	_____	125.9E-09
	-50	500	500	TUNED RF	7.943E-09	_____	12.59E-09
	-60	500	500	TUNED RF	794.3E-12	_____	1.259E-09
	-70	500	500	TUNED RF	79.43E-12	_____	125.9E-12
	-80 ¹	500	500	TUNED RF	7.943E-12	_____	12.59E-12
	-90	500	500	TUNED RF	794.3E-15	_____	1.259E-12
	-100	500	500	TUNED RF	79.43E-15	_____	125.9E-15
	-110	500	500	TUNED RF	7.943E-15	_____	12.59E-15
	-120	500	500	TUNED RF	794.3E-18	_____	1.259E-15
	-127	500	500	TUNED RF	158.5E-18	_____	251.2E-18
0 ⁵	500	500	TUNED RF	_____	_____	_____	

¹ On the HP 8902A Measuring Receiver press CALIBRATE before continuing test.
^{4, 5} On the HP 8902A Measuring Receiver, press blue SHIFT, STORE, followed by the numeric key indicated by the note number.
⁸ HP 8642B only.
⁹ HP 8642A only.

PERFORMANCE TESTS

Band	HP 8642 AMPTD (dBm)	8642 FREQ (MHz)	Measuring Receiver Frequency (MHz)	Measuring Receiver Mode	Results (watts)		
					Min.	Actual	Max.
9	+17 ⁸	1000	1000	RF POWER	39.81E-03	_____	63.09E-03
	+16 ⁹	1000	1000	RF POWER	31.62E-03	_____	50.12E-03
	+9.9	1000	1000	RF POWER	7.762E-03	_____	12.30E-03
	+5	1000	1000	RF POWER	2.510E-03	_____	3.981E-03
9	0 ¹	1000	1000	TUNED RF	794.3E-06	_____	1.259E-03
	-10	1000	1000	TUNED RF	79.43E-06	_____	125.9E-06
	-20	1000	1000	TUNED RF	7.943E-06	_____	12.59E-06
	-30	1000	1000	TUNED RF	794.3E-09	_____	1.259E-06
	-40 ¹	1000	1000	TUNED RF	79.43E-09	_____	125.9E-09
	-50	1000	1000	TUNED RF	7.943E-09	_____	12.59E-09
	-60	1000	1000	TUNED RF	794.3E-12	_____	1.259E-09
	-70	1000	1000	TUNED RF	79.43E-12	_____	125.9E-12
	-80 ¹	1000	1000	TUNED RF	7.943E-12	_____	12.59E-12
	-90	1000	1000	TUNED RF	794.3E-15	_____	1.259E-12
	-100	1000	1000	TUNED RF	79.43E-15	_____	125.9E-15
	-110	1000	1000	TUNED RF	7.943E-15	_____	12.59E-15
	-120	1000	1000	TUNED RF	794.3E-18	_____	1.259E-15
	-127	1000	1000	TUNED RF	158.5E-18	_____	251.2E-18
0 ⁶	1000	1000	TUNED RF	---	_____	---	
10 ⁸	+16	1300	1300	RF POWER	31.62E-03	_____	50.12E-03
10 ⁸	0 ¹	1300	1300	TUNED RF	794.3E-06	_____	1.259E-03
	-10	1300	1300	TUNED RF	79.43E-06	_____	125.9E-06
	-20	1300	1300	TUNED RF	7.943E-06	_____	12.59E-06
	-30	1300	1300	TUNED RF	794.3E-09	_____	1.259E-06
	-40 ¹	1300	1300	TUNED RF	79.43E-09	_____	125.9E-09
	-50	1300	1300	TUNED RF	7.943E-09	_____	12.59E-09
	-60	1300	1300	TUNED RF	794.3E-12	_____	1.259E-09
	-70	1300	1300	TUNED RF	79.43E-12	_____	125.9E-12
	-80 ¹	1300	1300	TUNED RF	7.943E-12	_____	12.59E-12
	-90	1300	1300	TUNED RF	794.3E-15	_____	1.259E-12
	-100	1300	1300	TUNED RF	79.43E-15	_____	125.9E-15
	-110	1300	1300	TUNED RF	7.943E-15	_____	12.59E-15
	-120	1300	1300	TUNED RF	794.3E-18	_____	1.259E-15
	-127	1300	1300	TUNED RF	158.5E-18	_____	251.2E-18
0 ⁷	1300	1300	TUNED RF	---	_____	---	
10 ⁸	+16	2000	2000	RF POWER	31.62E-03	_____	50.12E-03
	+9.9	2000	2000	RF POWER	7.762E-03	_____	12.30E-03
	+5	2000	2000	RF POWER	2.510E-03	_____	3.981E-03
	0	2000	2000	RF POWER	794.3E-06	_____	1.259E-03
	-10	2000	2000	RF POWER	79.43E-06	_____	125.9E-06
	-20	2000	2000	RF POWER	7.943E-06	_____	12.59E-06

¹ On the HP 8902A Measuring Receiver press CALIBRATE before continuing test.

^{6, 7} On the HP 8902A Measuring Receiver, press blue SHIFT, STORE, followed by the numeric key indicated by the note number.

⁸ HP 8642B Only.

⁹ HP 8642A Only.

PERFORMANCE TESTS

4-6. HARMONICS TESTS

SPECIFICATION:

Electrical Characteristics	Performance Limits	Conditions
Harmonics	-20 dBc -25 dBc -30 dBc	≤+16 dBm ≤+10 dBm, band 10 ≤+10 dBm, band HET-9
Sub-harmonics	none -45 dBc	band HET-9 band10

DESCRIPTION: The HP 8642's frequency is set to values where harmonic performance problems are most likely to be observed. The measuring receiver is used to measure the power level at the harmonic or sub-harmonic frequency. To do this, the measuring receiver must have been calibrated over the full power measurement range at that frequency. Doing the Level Accuracy Performance Test automatically does this.

For troubleshooting purposes or characterization of other RF frequencies, a spectrum analyzer may be used.

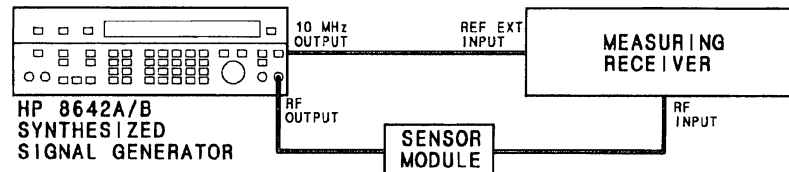

Figure 4-2. Harmonics Test Setup

EQUIPMENT: Measuring Receiver HP8902A
 Sensor Module HP11722A

PROCEDURE: 1a. Setup

Connect the instruments as shown in Figure 4-2. Preset the instruments. Set the measuring receiver to tuned RF Level mode. If the Level Accuracy Performance Test has just been done with the same measuring receiver then continue with step 2. If Level Accuracy has not yet been done or you have changed measuring receivers then calibration is required. In this case, complete step 1b before continuing with step 2.

PERFORMANCE TESTS

1b. Calibration

Perform the Level Accuracy Performance Test at the following frequencies: 3, 10, 100, 500, 1000 (and 1300 MHz for 8642B), and levels: 0, -40, -80 dBm. (If the measuring receiver is an HP 8902, store calibration values when instructed by notes 2-7 in 4-5 tables.)

2. Harmonics/Sub-Harmonic

Set the HP 8642 amplitude and frequency to the values in the following table. Set the measuring receiver to the frequencies in the third column. Verify the level is below the specified minimum.

HP 8642 AMPTD (dBm)	HP 8642 FREQ (MHz)	Harmonic/ Sub-Harmonic (MHz)	Results	
			Min.	Actual
+14.0	1.000000	3.0 ²	25.12E-06	_____
+14.0	1.500000	3.0 ²	25.12E-06	_____
+14.0	166.666667	500.0 ⁵	25.12E-06	_____
+14.0	250.000000	500.0	25.12E-06	_____
+10.0	2000.000000	1000.0 ⁶	316.2E-09	_____
+14.0	500.000000	1000.0	25.12E-06	_____
+14.0	333.333333	1000.0	25.12E-06	_____

2. 3. 5. 6On the HP 8902A Measuring Receiver, press blue SHIFT, RECALL, followed by the numeric key indicated by this note.

PERFORMANCE TESTS

4-7. PULSE ON/OFF RATIO TEST

SPECIFICATION:

Electrical Characteristics	Performance Limits	Conditions
On/Off Ratio	> 40 dB	band HET-9
	> 80 dB	band 10

DESCRIPTION: Pulse On/Off Ratio is measured by using the measuring receiver to measure the power output of the HP 8642 without modulation and in Pulse mode with no modulating signal. The ratio is measured at worst case frequencies for the HP 8642.

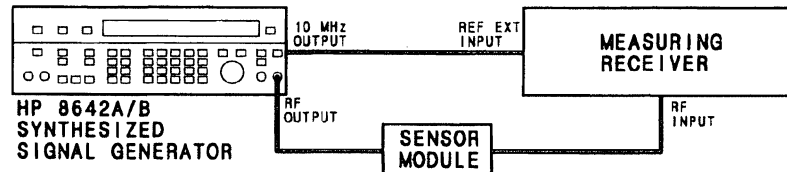

Figure 4-3. Pulse Test Setup

EQUIPMENT: Measuring Receiver HP 8902A
 Sensor Module HP 11722A

PROCEDURE: 1a. Setup

Connect the instruments as shown in Figure 4-3. Preset the instruments. Set the measuring receiver to tuned RF Level mode. If the Level Accuracy Performance Test has just been done with the same measuring receiver then continue with step 2. If Level Accuracy has not yet been done or you have changed measuring receivers then calibration is required. In this case, complete step 1b before continuing with step 2.

PERFORMANCE TESTS

1b. Calibration

Perform the Level Accuracy Performance Test at 1000 MHz (also use 1300 MHz for 8642B), and 0, -40, -80 dBm. (If the measuring receiver is an HP 8902, store calibration values when instructed by notes 2-7 in 4-5 tables.)

2. On/Off Ratio

On the HP 8642 key in AMPTD +10 dBm, SHIFT, PULSE, ON/OFF, EXT DC. This will put the HP 8642 in pulse modulation mode with the modulation waveform in its off state. Put the measuring receiver in Tuned RF Level Mode. Set the HP 8642 and measuring receiver frequency to the values listed in the table below. Verify the readings are lower than the specified maximum.

RF Frequency (MHz)	Results	
	Actual	Max.
1000.0 ⁶	_____	1.00 E - 6W
1300.0 ^{7*}	_____	100.00 E - 12W
<small>6.7 On the HP 8902A Measuring Receiver, press blue SHIFT, RECALL, followed by the numeric key indicated by this note. * 8642B only.</small>		

PERFORMANCE TESTS

4-8. RESIDUALS TESTS

SPECIFICATION:

Electrical Characteristics	Performance Limits	Conditions
Residual AM (0.3 to 3 kHz BW)	<0.01% AM rms	
Residual FM (0.3 to 3 kHz BW)	<5.0 Hz rms	band 10
	<2.0	band 9
	<1.2	band 8
	<1.0	band 1-7
	<3.5	band HET
Residual FM (0.05 to 15 kHz BW)	<9.0 Hz rms	band 10
	<5.0	band 9
	<2.0	band 8
	<1.2	band 1-7
	<5.0	band HET

DESCRIPTION: Residuals are demodulated by the measuring receiver using either AM or FM mode. FM Residual levels are measured in areas where the measuring receiver can resolve the measured performance of the HP 8642 under test (in a 0.3 - 3 kHz Bandwidth). If the HP 8642 has been repaired, the **OPTIONAL RESIDUAL FM TEST (4-18)**, should be performed in addition to this test. Also, if the Residual FM Test fails, it will be necessary to run 4-18 at the test points given here in 4-8 to determine if the noise source is the measuring receiver LO or the HP 8642.

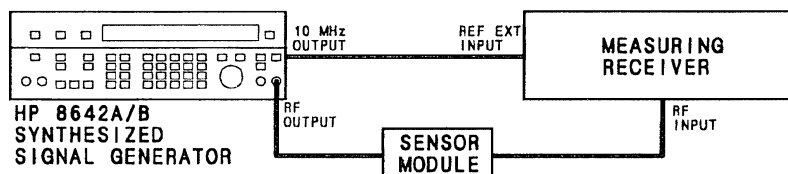

Figure 4-4. Residuals Test Setup

EQUIPMENT: Measuring Receiver HP8902A
 Sensor Module HP11722A

PERFORMANCE TESTS

PROCEDURE: 1. Setup

Connect the equipment as shown in Figure 4-4. Preset the instruments. On the measuring receiver, enable the 300 Hz HP Filter and the 3 kHz LP Filter.

2. Residual AM

Put the measuring receiver in AM mode using the rms detector. Set the HP 8642 to the levels and frequencies in the following table and verify that the measuring receiver reading is less than the specified maximum.

8642 AMPTD (dBm)	8642 FREQ	Results	
		Actual	Max
18	1 MHz	_____	0.010%
18	1 GHz	_____	0.010%
16	1.3 GHz ¹	_____	0.010%
5	1 MHz	_____	0.010%
5	1 GHz	_____	0.010%
5	1.3 GHz ¹	_____	0.010%

¹ 8642B only.

3. Residual FM

Put the measuring receiver in FM mode and leave the rms detector enabled. Set the HP 8642 to the levels and frequencies in the following table and verify that the measuring receiver reading is less than the specified maximum.

8642 AMPTD (dBm)	8642 FREQ	Results (kHz)	
		Actual	Max
10	250 MHz	_____	0.0010
10	0.5 GHz	_____	0.0012
10	1 GHz	_____	0.0020
10	1.3 GHz	_____	0.0050

PERFORMANCE TESTS

4-9. AM, FM and PM TESTS

SPECIFICATION:

Electrical Characteristics	Performance Limits	Conditions																
AMPLITUDE MODULATION																		
Depth	0 to 99.9%	Level $\leq +10$																
Resolution	0.1%																	
Incidental PM	0.20 radians peak	1 kHz Rate 30% AM																
Indicator Accuracy (1 kHz rate, up to 90% AM)	$\pm(3.5\%$ of reading $+1\%$ AM) $\pm(5\%$ of setting $+1\%$ AM)	8642A Bands 1-8, HET; 8642B Bands 1-9, HET 8642A Band 9, 8642B Band 10																
AM Distortion at 1 kHz rate	<p style="text-align: center;">8642A</p> <table style="width: 100%; border-collapse: collapse;"> <tr> <td style="text-align: center; border-bottom: 1px solid black;">Bands 1-8</td> <td style="text-align: center; border-bottom: 1px solid black;">Band 9, HET</td> </tr> <tr> <td style="text-align: center;"><1%</td> <td style="text-align: center;"><2%</td> </tr> <tr> <td style="text-align: center;"><2%</td> <td style="text-align: center;"><4%</td> </tr> <tr> <td style="text-align: center;"><4%</td> <td style="text-align: center;"><6%</td> </tr> </table> <p style="text-align: center;">8642B</p> <table style="width: 100%; border-collapse: collapse;"> <tr> <td style="text-align: center; border-bottom: 1px solid black;">Bands 1-9</td> <td style="text-align: center; border-bottom: 1px solid black;">Band 10, HET</td> </tr> <tr> <td style="text-align: center;"><1%</td> <td style="text-align: center;"><2%</td> </tr> <tr> <td style="text-align: center;"><2%</td> <td style="text-align: center;"><4%</td> </tr> <tr> <td style="text-align: center;"><4%</td> <td style="text-align: center;"><6%</td> </tr> </table>	Bands 1-8	Band 9, HET	<1%	<2%	<2%	<4%	<4%	<6%	Bands 1-9	Band 10, HET	<1%	<2%	<2%	<4%	<4%	<6%	0 to 30% AM 30 to 70% AM 70 to 90% AM 0 to 30% AM 30 to 70% AM 70 to 90% AM
Bands 1-8	Band 9, HET																	
<1%	<2%																	
<2%	<4%																	
<4%	<6%																	
Bands 1-9	Band 10, HET																	
<1%	<2%																	
<2%	<4%																	
<4%	<6%																	
FREQUENCY MODULATION																		
3 dB Bandwidth																		
Internal	dc to >200 kHz																	
External ac	<20 Hz to >200 kHz																	
External dc	20 Hz to 100 kHz																	
Maximum Peak Deviation (ac coupled and internal)	The smaller of: 3 MHz or $f_{mod} \times 2160$ 1.5 MHz or $f_{mod} \times 1080$ 750 kHz or $f_{mod} \times 540$ 375 kHz or $f_{mod} \times 270$ 187 kHz or $f_{mod} \times 135$ 93.8 kHz or $f_{mod} \times 67.5$ 46.9 kHz or $f_{mod} \times 33.75$ 23.4 kHz or $f_{mod} \times 16.88$ 11.7 kHz or $f_{mod} \times 8.44$ 93.8 kHz or $f_{mod} \times 67.9$	band 10 9, HET 8 7 6 5, 1 4 3 2 1																

PERFORMANCE TESTS

Electrical Characteristics	Performance Limits	Conditions
FREQUENCY MODULATION		
(Cont'd)		
Maximum Peak Deviation (dc coupled)	3 MHz	band 10
	1.5 MHz	9, HET
	750 kHz	8
	375 kHz	7
	187 kHz	6
	93.8 kHz	5, 1
	46.9 kHz	4
	23.4 kHz	3
	11.7 kHz	2
	93.8 kHz	1
1.5 MHz	HET	
Indicator Accuracy (Rates \leq 100 kHz)	$\pm(5\%$ of reading +10 Hz)	
FM Resolution	The larger of: 0.7% of setting or 0.0004% of max deviation	
Incidental AM (1 kHz rate)	0.030%	20 kHz deviation, 1 kHz rate, > 400 kHz carrier
FM Distortion (Rates 20 Hz to 100 kHz)	0.4%	1/15 max dc coupled deviation
	2.0%	1/2 max dc coupled deviation
	4.0%	max dc coupled deviation
Frequency Offset (Rates 20 Hz to 100 kHz)	None	internal and ac
	2.0%	1/2 max dc coupled deviation
	4.0%	max dc coupled deviation
FM Distortion (Rates 20 Hz to 100 kHz)	0.4%	1/15 max dc coupled deviation
	2.0%	1/2 max dc coupled deviation
	4.0%	max dc coupled deviation
Frequency Offset	None	internal and ac
	< 500 Hz	dc
	< 1 kHz	dc, band 10
PHASE MODULATION		
Maximum Peak Deviation	200 radians	band 10
	100 radians	9, HET
	50 radians	8
	25 radians	7
	12.5 radians	6
	6.25 radians	5, 1
	3.13 radians	4
	1.56 radians	3
	0.78 radians	2

PERFORMANCE TESTS

Electrical Characteristics	Performance Limits	Conditions
PHASE MODULATION (Cont'd)		
Indicator Accuracy (1 kHz rate)	$\pm(5\% \text{ of reading} + 0.9 \text{ rad})$	
Resolution	The larger of: 0.75% of setting or 0.0004% of max deviation	
Distortion (1 kHz rate)	< 0.4%	20 kHz deviation, 1 kHz rate, > 400 kHz carrier
3 dB Bandwidth int, ext ac ext dc	20 Hz to 15 kHz dc to 15 kHz	

PERFORMANCE TESTS

3. Incidental PM

Set the HP 8642 AM to 30%. Set the measuring receiver to PM mode and leave the 300 Hz HP filter and 15 kHz LP filter enabled. Set the HP 8642 RF Frequency to the values listed in the table below and verify that the measuring receiver readings are within the specified limits.

HP 8642 FREQ (MHz)	Results	
	Actual	Max.
8.0000	_____	0.20 rad
1300.0	_____	0.20 rad

4. AM Distortion

Set the measuring receiver back to AM then to audio distortion mode. Set the HP 8642 RF frequency and AM depth to the values listed in the table below and verify that the measuring receiver readings are within the specified limits.

HP 8642 FREQ (MHz)	AM (%)	Results	
		Actual	Max.
0.15	30	_____	1.0%
0.15	70	_____	2.0%
0.15	90	_____	4.0%
1050 ¹	30	_____	2.0%
1050 ¹	70	_____	4.0%
1050 ¹	90	_____	6.0%
1300 ²	30	_____	2.0%
1300 ²	70	_____	4.0%
1300 ²	90	_____	6.0%
500	30	_____	1.0%
500	70	_____	2.0%
500	90	_____	4.0%

¹ HP 8642A only.
² HP 8642B only.

PERFORMANCE TESTS

5. PM Indicated Accuracy and Distortion

Set the measuring receiver to PM mode with the 300 Hz HP filter and the 15 kHz LP filter selected. Turn off the HP 8642 AM. Set the RF frequency and PM deviation to the first values in the table below. Verify that the measuring receiver reading for phase deviation is within the specified limits. Set the measuring receiver to distortion mode and verify that the distortion reading does not exceed maximum. Repeat phase deviation and distortion tests for the remaining HP 8642 settings.

FREQ (MHz)	PM (rad.)	Results				
		PM			Distortion	
		Min.	Actual	Max.	Actual	Max.
8.00	0.781	0.651	_____	0.909 rad	_____	0.4%
1050	100.0	94.9	_____	105.1 rad	_____	0.4%
0.15	100.0	94.9	_____	105.1 rad	_____	0.4%

6. DC FM Center Frequency

Preset the instruments. On the HP 8642 key in AMPT +10 dB, FM, 180 kHz, EXT DC. On the measuring receiver, enable 10 Hz resolution ¹. Verify the reading is within the specified limits.

FREQ (MHz)	Results		
	Min.	Actual	Max.
100.00000	99.99950 MHz	_____	100.00050 MHz

¹ If the measuring receiver is an HP 8902, key in 7.1 SPCL.

PERFORMANCE TESTS

7. FM Indicated Accuracy

Preset instruments. Set the HP 8642 amplitude to +10 dBm. Set the measuring receiver to FM mode with all filters off. Set the HP 8642 modulation frequency, RF frequency, and FM deviation to the values given in the table below and verify that the FM deviation readings on the measuring receiver are within the specified limits.

MOD FREQ (kHz)	FREQ (MHz)	FM (kHz)	Results		
			Min.	Actual FM	Max.
0.02	8	1.35	1.28 kHz	_____	1.42 kHz
100	1050	100.0	95.0 kHz	_____	105.0 kHz
100	256	25.0	23.7 kHz	_____	26.3 kHz
100	256	187.0	177.6 kHz	_____	196.4 kHz
100	256	375.0	356.2 kHz	_____	393.8 kHz
10	8	0.781	0.732 kHz	_____	0.830 kHz
10	8	5.85	5.55 kHz	_____	6.15 kHz
10	8	11.7	11.1 kHz	_____	12.3 kHz
10	4	93.8	89.1 kHz	_____	98.5 kHz

8. Incidental AM

Set the measuring receiver to AM mode with 50 Hz high pass filter, 3 kHz low pass filter, and the PEAK + detector selected. On the HP 8642, set FM to Off, and set the frequency to 100, 1050, and 1300 MHz (1300 for 8642B only). The measuring receiver's reading must be less than 0.02% at these frequencies. If the reading is too high, it means the residual AM of the measuring receiver (or possibly of the HP 8642) is too high to make the incidental AM measurement. Determine the cause of the high residual AM before proceeding. If the reading is less than 0.02%, set the HP 8642 to FM to 20 kHz deviation and modulation frequency to 1 kHz. Set the HP 8642 frequency to the settings in the table below and verify that the measuring receiver readings are less than the specified maximum.

FREQ (MHz)	Results	
	Actual	Max.
100.0	_____	0.30%
1050.0	_____	0.30%
1300.0	_____	0.30%

PERFORMANCE TESTS

9. FM Distortion (1 kHz)

Preset the instruments. Set the measuring receiver to FM mode and audio distortion mode. Turn off all audio Filters. Set the HP 8642 amplitude to +10 dBm. Set the HP 8642 RF frequency and FM deviation to the values listed in the table below. Verify that the measuring receiver readings are less than the specified maximum.

FREQ (MHz)	FM (kHz)	Results	
		Actual Distortion	Max.
1050	72.0	_____	0.4%
256	135.0	_____	2.0%
4	67.5	_____	4.0%

PERFORMANCE TESTS

4-10. EXTENDED FM DISTORTION TEST

SPECIFICATION:

Electrical Characteristics	Performance Limits	Conditions
FREQUENCY MODULATION		
FM Distortion (20 Hz to 100 kHz)	0.4% 2.0% 4.0%	1/15 max dc coupled deviation 1/2 max dc coupled deviation max dc coupled deviation

DESCRIPTION: All FM distortion specifications are checked by demodulating the signal with the measuring receiver. The modulation output of the measuring receiver is then fed into the input of an audio analyzer and measured.

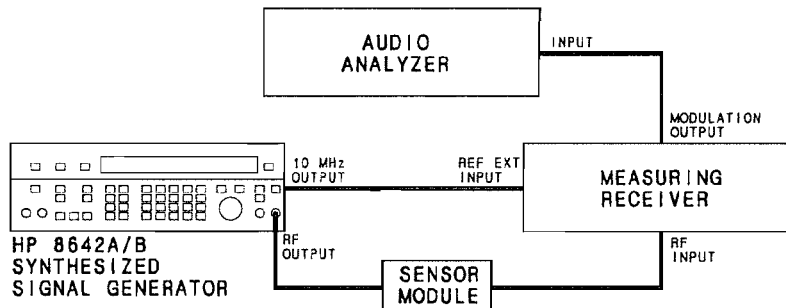

Figure 4-6. FM Distortion Test Setup

EQUIPMENT:

Measuring Receiver	HP 8902A
Sensor Module	HP 11722A
Audio Analyzer	HP 8903A

PROCEDURE: 1. Connect the instruments as shown in Figure 4-6 and apply power.

Set up HP 8642 as follows:

INSTRUMENT PRESET
AMPLITUDE: +10 dBm

PERFORMANCE TESTS

Set up measuring receiver as follows:

```

INSTRUMENT PRESET
MEASUREMENT MODE:      FM
HP FILTER:              ALL OFF
LP FILTER:              ALL OFF
FM DE-EMPHASIS:       OFF
  
```

Set up audio analyzer as follows:

```

INSTRUMENT PRESET
MEASUREMENT MODE:      DISTN
HP/BPF FILTER:        ALL OFF
LP FILTER:             ALL OFF
  
```

2. FM Distortion Measurement

Set the HP 8642 to the modulation frequency, RF frequency, and FM deviation given in the table below. Verify that the distortion readings on the audio analyzer are less than the specified maximums given in the table below.

MOD FREQ (kHz)	FREQ (MHz)	FM (kHz)	Results	
			Actual Distn	Max.
0.02	8	1.35	_____	4.0%
100	1050	100.0	_____	0.4%
100	256	25.0	_____	0.4%
100	256	187.0	_____	2.0%
100	256	375.0	_____	4.0%
10	8	0.781	_____	0.4%
10	8	5.85	_____	2.0%
10	8	11.7	_____	4.0%
10	4	93.8	_____	4.0%

PERFORMANCE TESTS

4-11. INTERNAL MODULATION OSCILLATOR TESTS

SPECIFICATION:

Electrical Characteristics	Performance Limits	Conditions
FREQUENCY		
Range	20 Hz to 100 kHz	
Resolution	1% of setting	
Accuracy	2% of setting	
OUTPUT LEVEL		
Range	0 to 3 volts peak	600 ohm load
Resolution	4 mV	
Accuracy	±(4% off setting +15 mV)	within 1 second
Distortion (>0.5 volt peak)	<0.02% <0.15%	0.02-15.8 kHz >15.8 kHz
Output Impedance	600 ohms ±10%	

DESCRIPTION: All Internal Modulation Oscillator specifications are checked by measuring the specified parameters on an audio analyzer.

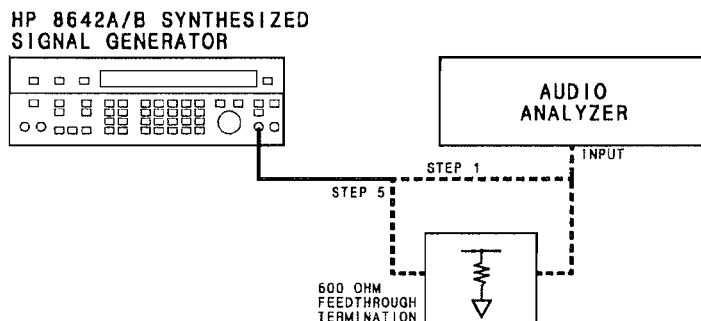

Figure 4-7. Internal Modulation Oscillator Test Setup

EQUIPMENT:

- Audio Analyzer HP 8903A
- Feedthrough Termination, 600 ohm ... HP 11095A

(a 600 ohm 1% resistor to ground can be substituted. Use HP part number 0757-1100 or 0698-4015.)

PERFORMANCE TESTS

PROCEDURE: Setup

1. Connect the instruments as shown in Figure 4-7. Preset the HP 8642 and audio analyzer. Set the audio analyzer filters off.
2. Level Accuracy

Set the HP 8642 modulation frequency and modulation output level to the values given in the table below. Verify that the readings are within the specified limits.

MOD FREQ	MOD OUT Level	Results		
		Min.	Actual	Max.
0.020 kHz*	50 mV	46.6 mV	_____	94.8 mV
1.000 kHz*	50 mV	46.6 mV	_____	94.8 mV
100.0 kHz	50 mV	46.6 mV	_____	94.8 mV
0.020 kHz*	3.00V	4.051V	_____	4.433V
1.000 kHz*	3.00V	4.051V	_____	4.433V
100.0 kHz	3.00V	4.051V	_____	4.433V

*Use the audio analyzer 30 kHz low pass filter at these points.

3. Frequency Accuracy

Set the HP 8642 modulation frequency to the values given in the table below and verify that the frequency indicated on the audio analyzer is within the specified limits.

MOD FREQ	Results		
	Min.	Actual	Max.
20.0 Hz	19.6	_____	20.4
14.9 kHz	14.60	_____	15.20
15.1 kHz	14.80	_____	15.40
100.0 kHz	98.00	_____	102.0

PERFORMANCE TESTS

4. Distortion

Change the audio analyzer mode to distortion. Set the HP 8642 modulation frequency and modulation output level to the values given in the table below. Verify that the readings are within the specified limits.

MOD FREQ	MOD OUT Level	Results	
		Actual	Max.
0.020 kHz	0.50V	_____	0.02%
15.80 kHz	0.50V	_____	0.02%
100.0 kHz	0.50V	_____	0.15%
0.020 kHz	3.00V	_____	0.02%
15.80 kHz	3.00V	_____	0.02%
100.0 kHz	3.00V	_____	0.15%

5. Output Impedance

Set the HP 8642 MOD FREQ to 1 kHz. Set the audio analyzer to AC level and ratio. Terminate the HP 8642 MOD OUTPUT with the 600 ohm, F16 4-7, feedthrough and re-connect the cable. Verify that the audio analyzer reading is within the specified limits.

Results		
Min.	Actual	Max.
47.78%	_____	52.77%

NOTE

To compute the actual output impedance (Zs):

$$6*(100-Actual\%) = Zs$$

PERFORMANCE TESTS

4-12. SWR TEST

SPECIFICATION:

Electrical Characteristics	Performance Limits	Conditions
SWR	<1.5:1 <2.0:1	<0 dBm ≥0 dBm

DESCRIPTION: SWR measurement is divided into two parts: High Level SWR and Low Level SWR.

In the High Level SWR Test, the HP 8642 frequency is set to the frequency of interest because the ALC loop output impedance is seen directly at the front panel RF output connector. This is the only frequency where the HP 8642 output impedance is valid. In this test the maximum and minimum of the standing wave are measured directly on a measuring receiver. The SWR is computed from the ratio of these two values.

In the Low Level SWR Test, the return loss is measured at each attenuator step for worst case frequencies. Return loss is measured by first measuring the power that will be applied to the HP 8642 RF Output. (This is done through the SWR bridge to calibrate out the loss of the bridge. Then the HP 8642 is connected to the SWR bridge and the reflected power is measured. The difference between the two measurements is the return loss. Note: The HP 8642 frequency is set so that it will not interfere with the measurement.

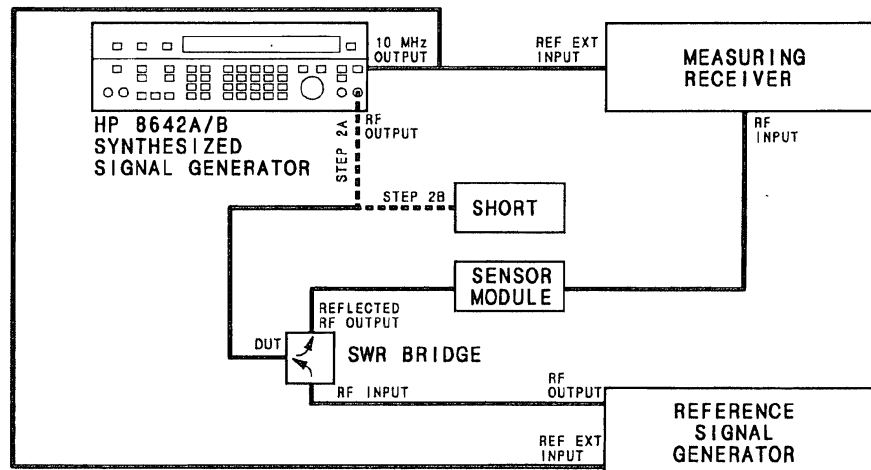

Figure 4-8. SWR Test Setup

PERFORMANCE TESTS

EQUIPMENT: Measuring Receiver HP 8902A
 Sensor Module HP 11722A
 SWR Bridge Wiltron 60NF50
 Type N Short HP 11512A
 Signal Generator HP 8642B

PROCEDURE: 1. High Level SWR Setup

Set up the measuring receiver as follows:

INSTRUMENT PRESET
 MEASUREMENT MODE: RF POWER
 DISPLAY MODE: LOG

Set up the Signal Generator as follows:

INSTRUMENT PRESET

Set up the HP 8642 as follows:

INSTRUMENT PRESET
 AMPLITUDE INCREMENT 0.1 dB

2a. Calibration

Connect the instruments as shown in Figure 4-8 step 2a. Set the HP 8642 and the Signal Generator to the frequency listed in the table below. Set the Signal Generator level to -80 dBm. Set the HP 8642 level listed in the table below. Make a reading on the measuring receiver and record it in the table below (Step 2a Reading). Repeat this step for all frequencies in the table.

2b. Connect the instruments as shown in Figure 4-8 step 2b. Set the Signal Generator level for 6 dB higher than the HP 8642 level. Make a reading of the signal level on the measuring receiver. Record this reading in the table below (Step 2b Reading). Repeat this step for all frequencies and levels in the table below.

2c. Now compute the Sig Gen Level setting to be used in the SWR Measurement for each frequency in the table.

$$\text{Sig Gen Level} = (\text{Step 2a Reading}) - (\text{Step 2b Reading}) + 6 + (\text{HP 8642 level})$$

PERFORMANCE TESTS

3a. Measurement

Re-connect the instruments as shown in Figure 4-8 step 2a. Set the Signal Generator and HP 8642 frequency to the value listed in the table below. Set the Signal Generator level to the **Sig Gen Level** recorded in the table below. Set the HP8642 level to the values given in the table below. On the HP 8642 enable the phase increment mode (SHIFT SPCL 250) and use the knob to vary the phase. As the phase of the HP 8642 is varied the readings on the measuring receiver should change. Record the maximum and minimum readings on the measuring receiver display in the table below.

3b. Subtract the Maximum from the Minimum reading in Step 3a and record the Result in the table below. Verify that the actual result is less than the specified Maximum.

Frequency (MHz)	8642 Level (dBm)	Step 2a Reading	Step 2b Reading	Sig Gen Level	Step 3 Readings		Results (Max-Min)	
					Min	Max	Actual	Maximum
4.000	10.0	_____	_____	_____	_____	_____	_____	6.02 dB
4.000	6.0	_____	_____	_____	_____	_____	_____	6.02 dB
4.000	-1.0	_____	_____	_____	_____	_____	_____	3.52 dB
4.000	-6.0	_____	_____	_____	_____	_____	_____	3.52 dB
1000.000	10.0	_____	_____	_____	_____	_____	_____	6.02 dB
1000.000	6.0	_____	_____	_____	_____	_____	_____	6.02 dB
1000.000	-1.0	_____	_____	_____	_____	_____	_____	3.52 dB
1000.000	-6.0	_____	_____	_____	_____	_____	_____	3.52 dB
2000.000	10.0	_____	_____	_____	_____	_____	_____	6.02 dB
2000.000	6.0	_____	_____	_____	_____	_____	_____	6.02 dB
2000.000	-1.0	_____	_____	_____	_____	_____	_____	3.52 dB
2000.000	-6.0	_____	_____	_____	_____	_____	_____	3.52 dB

NOTE

If actual SWR values are needed, compute SWR using the following formula:

$$SWR = 10^{((max - min \text{ in dBm}) / 20)}$$

PERFORMANCE TESTS

4. Low Level SWR Setup

Connect the instruments as shown in Figure 4-8 step 2b.

Set the Signal Generator to:

```

INSTRUMENT PRESET
LEVEL:                +16 dBm
FREQUENCY:            4 MHz
    
```

Set the HP 8642 to:

```

INSTRUMENT PRESET
FREQUENCY:            500 MHz
    
```

Set up the measuring receiver as follows:

```

INSTRUMENT PRESET
MODE:                  RF POWER
DISPLAY MODE:          LOG
    
```

5. Low Level SWR, Reference

Set the Signal Generator and measuring receiver frequency to values listed in the table below. Set the HP 8642 to the levels listed in the table. Measure the "Ref." at all settings and record each reading under "Intermediate Readings, Ref."

6. Low Level SWR, Reflection

Connect the instruments as shown in Figure 4-8 step 2a. Put the measuring receiver in RF POWER mode. Set the Signal Generator and measuring receiver frequency to values listed in the table below. Set the HP 8642 to the levels listed in the table. Measure the reflected power at all settings and record each reading under "Intermediate Readings, Reflected"

Signal Generator Frequency (MHz)	8642 AMPTD (dBm)	Intermediate Readings		Results (Return Loss)	
		Ref.	Reflected	Actual	Min.
4.000	-14.0				14.0 dB
4.000	-24.0				14.0 dB
1000.000	-14.0				14.0 dB
1000.000	-24.0				14.0 dB
1300.000	-14.0				14.0 dB
1300.000	-24.0				14.0 dB

PERFORMANCE TESTS

7. Low Level SWR, Return Loss Calculation

In each row in the preceding table compute the "Actual" return loss using the following formula:

$$\text{"Ref."} - \text{"Reflected"} = \text{"Actual"}$$

Verify that "Actual" is greater than the specified Min.

NOTE

If you wish to compute the actual SWR from the return loss at each frequency, you may use the following formula:

$$\text{SWR} = \frac{1 + [10^{-(\text{Return Loss}/20)}]}{1 - [10^{-(\text{Return Loss}/20)}]}$$

PERFORMANCE TESTS

4-13. SPURIOUS TEST

SPECIFICATION:

Electrical Characteristics	Performance Limits	Conditions
Non harmonic spurious	100 dBc 94 dBc	band HET-9 band 10

DESCRIPTION: The RF output of the HP 8642 is viewed on a spectrum analyzer. The 8642's frequency is set to values where spurious performance problems are most likely to be observed.

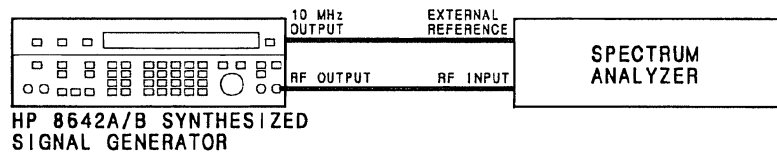

Figure 4-9. Harmonics and Spurious Test Setup

EQUIPMENT: Spectrum Analyzer HP 8566A

- PROCEDURE:**
1. Perform a center frequency calibration on the spectrum analyzer.
 2. Connect the instruments as shown in Figure 4-9.

3. Set up the spectrum analyzer as follows:

INSTRUMENT PRESET
SPAN 0 kHz
RESOLUTION BANDWIDTH 10 Hz

4. Set up the HP 8642 as follows:

INSTRUMENT PRESET

PERFORMANCE TESTS

5. Set the 8642's frequency and amplitude to values listed in the following table. Set the Spectrum Analyzer's reference level and frequency to the values given in the following table.
6. All spurious signals must be below the level stated in the table.

NOTE

In order to obtain maximum sensitivity, this test requires driving the input mixer of the spectrum analyzer above its optimum level. This could cause the generation of spurious signals in the spectrum analyzer. If a spurious signal is observed, change the 8642's frequency. If the spurious disappears, it most likely is from the HP 8642. If the spurious moves with the 8642's signal, it is probably generated in the spectrum analyzer.

8642		Spectrum Analyzer		Results (dBm)	
AMPTD (dBm)	FREQ (MHz)	CENTER FREQ (MHz)	Ref Level (dBm)	Min.	Actual
+20	4.130 000	85.870 000	+10	-80	_____
+20	4.130 000	3.700 000	+10	-80	_____
+20	4.130 000	0.430 000	+10	-80	_____
+20	4.130 000	4.560 000	+10	-80	_____
+20	4.130 000	5.870 000	+10	-80	_____
+5	4.130 000	45.000 000	-5	-95	_____
+5	4.130 000	225.000 000	-5	-95	_____
+5	90.000 000	112.500 000	-5	-96	_____
+5	600.000 000	596.313 600	-5	-96	_____
+5	600.000 000	599.078 400	-5	-96	_____
+5	571.144 000	572.796 000	-5	-96	_____
+5	610.519 000	612.171 000	-5	-96	_____
+5	745.951 000	747.608 000	-5	-96	_____
+5	775.184 000	776.836 000	-5	-96	_____
+5	780.184 000	781.840 000	-5	-96	_____
+5	797.878 000	799.536 000	-5	-96	_____
+5	965.416 000	967.076 000	-5	-96	_____
+5	1012.000 000	788.000 000	-5	-96	_____
+5	976.000 000	742.500 000	-5	-96	_____
+5	562.000 000	606.500 000	-5	-96	_____
+5	1057.500 000	1012.500 000	-5	-96	_____
+5	1057.500 000	1057.375 000	-5	-96	_____
+5	563.000 000	540.500 000	-5	-96	_____

PERFORMANCE TESTS

4-14. THIRD ORDER INTERMODULATION

SPECIFICATION:

Electrical Characteristics	Performance Limits	Conditions
Third Order Intermodulation	<-55 dBc.	+12 dBm, two generators 25 kHz apart into a resistive combiner.

DESCRIPTION: Intermodulation is checked by summing another Signal Generator and the HP 8642 into a spectrum analyzer. The intermodulation products are then measured on the spectrum analyzer.

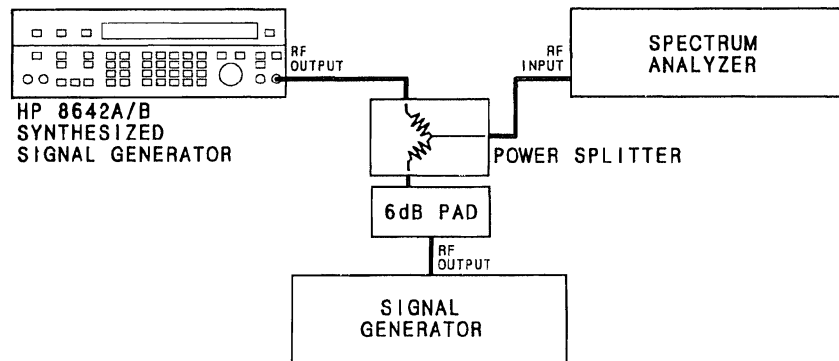

Figure 4-10. Intermodulation Test Setup

EQUIPMENT:

Spectrum Analyzer	HP 8566B	
Power Splitter	HP 11667A	
Signal Generator	HP 8642B	
6 dB Pad	HP 8491A opt. 006	

PROCEDURE:

1. Connect the instruments as shown in Figure 4-10.
2. Set up the HP 8642 as follows:

INSTRUMENT PRESET	
AMPLITUDE	+12 dBm
FREQ	1050 MHz

PERFORMANCE TESTS

3. Set up the Signal Generator as follows:

INSTRUMENT PRESET
 AMPLITUDE +18 dBm
 FREQ 1050.025 MHz

4. Set up the spectrum analyzer as follows:

INSTRUMENT PRESET

5. Adjust the Signal Generator level until it is equal to the HP 8642 level, using the spectrum analyzer as the measuring device.
6. On the spectrum analyzer measure the signal at 1049.975 MHz relative to the signal at 1050.000 MHz. Verify that it is below the required level given below.

8642 RF Frequency (MHz)	Signal Generator Frequency (MHz)	Results	
		Actual	Max
1050.000	1050.025	_____	-55 dBc

PERFORMANCE TESTS

4-15. SSB PHASE NOISE TEST

SPECIFICATION:

Electrical Characteristics	Performance Limits		Conditions
	20 kHz Offset	200 kHz Offset	
Residual SSB Phase Noise in 1 Hz Bandwidth	-125 dBc	-134 dBc	band 10
	-134 dBc	-143 dBc	9
	-137 dBc	-144 dBc	8
	-141 dBc	-144 dBc	7
	-144 dBc	-145 dBc	6
	-145 dBc	-145 dBc	5
	-146 dBc	-147 dBc	4
	-147 dBc	-148 dBc	3
	-148 dBc	-149 dBc	2
	-137 dBc	-138 dBc	1
	-125 dBc	-137 dBc	HET

DESCRIPTION: SSB phase noise is measured by mixing the RF output of the HP 8642 and its 10 MHz reference signal in a double balanced mixer to eliminate the carrier and translate the noise spectrum down to a low frequency where it can be viewed on a high resolution spectrum analyzer. The 10 MHz reference output from the HP 8642's rear panel is used as the LO input for the mixer. The HP 8642's output is set to 10 MHz and is used as the RF input to the mixer. The output of the mixer is viewed on a spectrum analyzer at 20 kHz.

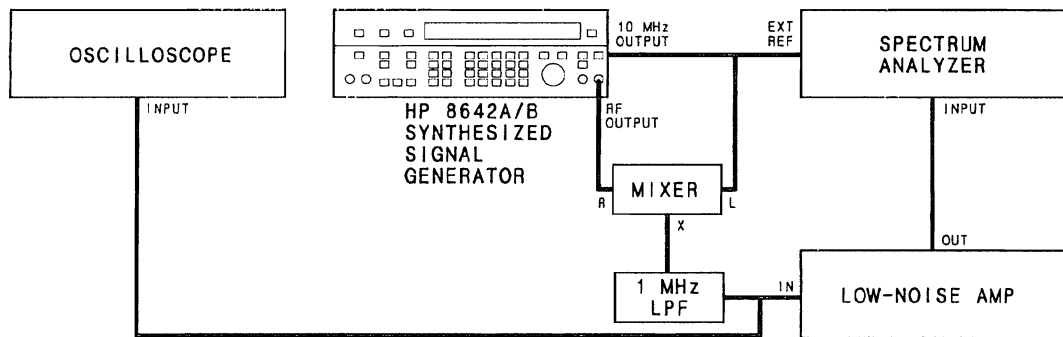

Figure 4-11. SSB Phase Noise Test Setup

PERFORMANCE TESTS

NOTE

This test is a good overall check of the phase noise performance of the HP 8642. However, if it is necessary to check phase noise at a specific output frequency, perform test 4-16 or use an HP Phase Noise Measurement System to verify the performance.

EQUIPMENT: Mixer HP 10514A
 1 MHz Low Pass Filter (See Figure 1-1)
 Low-Noise Amplifier HP 08640-60506
 W/Power Supply HP 6216A
 Spectrum Analyzer HP 8566A/B
 Oscilloscope HP 1980B

- PROCEDURE:
1. Connect the instruments as shown in Figure 4-11. Preset the instruments. Insure that the spectrum analyzer center frequency calibration is accurate.
 2. On the HP 8642, enter SPCL 8. Set the HP 8642 to 10.020 MHz and -50 dBm amplitude.
 3. Set up the Spectrum Analyzer as follows:

VIDEO BW	1Hz
SWEEP TIME	5.0 sec
ATTENUATION	0 dB
RESOLUTION	10 Hz
CENTER FREQ.	20 kHz
SPAN	0 Hz
REFERENCE LEVEL	-50 dBm

- 4.

NOTE

It may be necessary to fine tune the spectrum analyzer center frequency adjustment. The spectrum analyzer band width will be centered when the maximum signal level is obtained while tuning the center frequency adjustment.

Record the level of the 20 kHz peak signal for later use.

PERFORMANCE TESTS

5. Set the HP 8642 to 10.0 MHz then 0 dBm amplitude by incrementing the amplitude in 10 dB steps.



Using the oscilloscope, verify that no large AC signal is present. If AC is present the mixer input signals are not at the same frequency and spectrum analyzer damage may result.

6. On the HP 8642, enter SPCL 250. View the signal in the dc coupled mode on the oscilloscope. Use the HP 8642 knob to adjust the dc level on the oscilloscope as close to zero as possible. This sets the two input signals to the mixer in phase quadrature (90 degrees out of phase).
7. View the trace and note the average noise level.
8. The actual phase noise is calculated from the reading obtained in step 6 by applying the following corrections:
 - a. Subtract the reading from step 4 to convert the reading to units of dBc.
 - b. Add -63.5 dB. (-50 dB for 8642 attenuator change, -10 dB for 1 Hz bandwidth normalization, -6 dB for single side band conversion, +2.5 dB to correct for the Log shaping and average detection.)
9. Phase noise should be -125 dB or lower.

-125 dBc _____

PERFORMANCE TESTS

4-16. SSB PHASE NOISE TEST (OPTIONAL)

SPECIFICATION

Electrical Characteristics	Performance Limits		Conditions
	20 kHz Offset	200 kHz Offset	
Residual SSB Phase	-125 dBc	-134 dBc	band 10
Noise in 1 Hz	-134 dBc	-143 dBc	9
Bandwidth	-137 dBc	-144 dBc	8
	-141 dBc	-144 dBc	7
	-144 dBc	-145 dBc	6
	-145 dBc	-145 dBc	5
	-146 dBc	-147 dBc	4
	-147 dBc	-148 dBc	3
	-148 dBc	-149 dBc	2
	-137 dBc	-138 dBc	1
	-125 dBc	-137 dBc	HET

DESCRIPTION: This test is an alternative to the test in paragraph 4-15. This test should be performed only if it is necessary to check phase noise at frequencies other than 10 MHz.

An LO and a double-balanced mixer are used to translate the noise spectrum to a lower frequency so that it can be viewed on a high resolution spectrum analyzer.

NOTE

This test measures the total SSB phase noise of both 8642s. Therefore, the LO must have SSB phase noise that is less than or equal to the specification for the HP 8642 under test.

PERFORMANCE TESTS

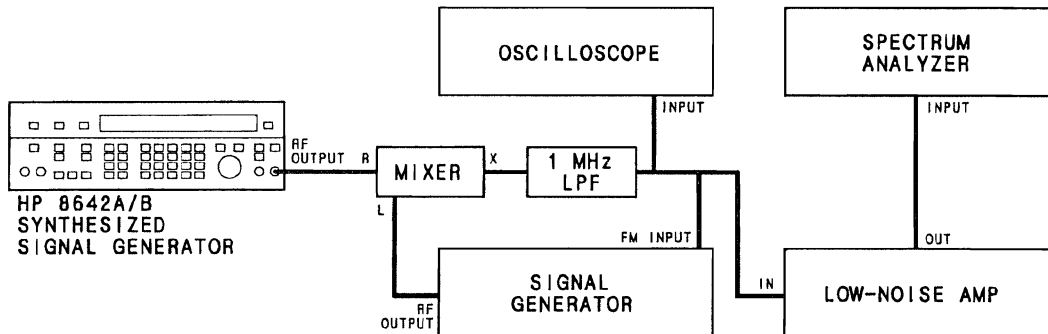

Figure 4-12. SSB Phase Noise Test Setup (Optional)

- EQUIPMENT:**
- Mixer HP 10514A
 - 1 MHz Low Pass Filter (See Figure 1-1)
 - Low-Noise Amplifier HP 08640-60506
 - W/Power Supply HP 6216A
 - Spectrum Analyzer HP 8566A
 - Oscilloscope HP 1980B
 - LO HP 8642B

- PROCEDURE:**
1. Connect the instruments as shown in Figure 4-12. On the LO, select external DC FM and 1 kHz FM deviation. Insure that the spectrum analyzer center frequency calibration is accurate.

NOTE

The following symbols are used in the procedure:

f_{RF} = the RF output frequency where SSB phase noise will be checked.

f_{OFF} = the frequency offset from f_{RF} where SSB phase noise will be checked.

2. Set the LO's frequency to f_{RF} and the output level to +16 dBm. Set the HP 8642 under test to $f_{RF} + f_{OFF}$ and the output level to -50 dBm.

PERFORMANCE TESTS

3. Set up the Spectrum Analyzer as follows:

VIDEO BW	1 Hz
SWEEP TIME	5.0 sec
ATTENUATION	0 dB
RESOLUTION	10 Hz
CENTER FREQ.	F_{off}
SPAN	0 Hz
REFERENCE LEVEL	-50 dBm

4. Record the level of the F_{off} peak signal for later use.

NOTE

It may be necessary to fine tune the spectrum analyzer center frequency adjustment. The spectrum analyzer band width will be centered when the maximum signal level is obtained while tuning the center frequency adjustment.

5. Set the HP 8642 to F_{RF} then 0 dBm amplitude by incrementing the amplitude in 10 dB steps.



Use the oscilloscope to verify that no large AC signal is present. If AC is present the mixer input signals are not at the same frequency and spectrum analyzer damage may result.

6. On the HP 8642, enter SPCL 250. View the signal in the dc coupled mode on the oscilloscope. Use the HP 8642 knob to adjust the dc level on the oscilloscope as close to zero as possible. This sets the two input signals to the mixer in phase quadrature (90 degrees out of phase).
7. View the trace and note the average noise level.

PERFORMANCE TESTS

8. The actual phase noise is calculated from the reading obtained in step 6 by applying the following corrections:
 - a. Subtract the reading from step 4 to convert the reading to units of dBc.
 - b. Add -63.5 dB. (-50 dB for 8642 attenuator change, -10 dB for 1 Hz bandwidth normalization, -6 dB for single side band conversion, +2.5 dB to correct for the Log shaping and average detection.)

PERFORMANCE TESTS

4-17. EXTENDED PULSE TESTS

SPECIFICATION:

Electrical Characteristics	Performance Limits	Conditions
On/Off Ratio	>30 dB >45 dB	band 10 10% to 90% of final value
Rise/Fall Time	<3.5 μ sec	
Rate	50 kHz maximum	
Pulse Width	6 μ sec minimum	
Trigger Level	1.5 volts nominal	

DESCRIPTION: All Pulse specifications are checked by measuring the specified parameters on an oscilloscope after the waveform has been demodulated by a spectrum analyzer.

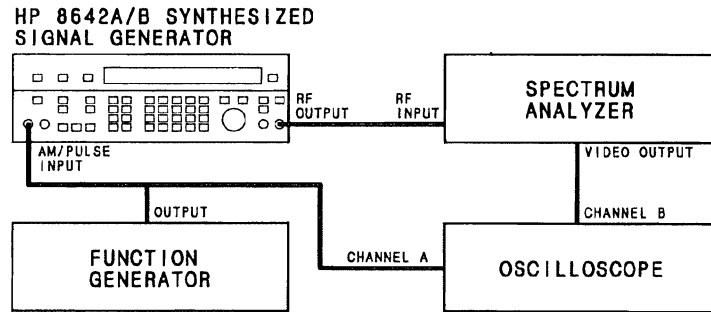

Figure 4-13. Pulse Test Setup

EQUIPMENT:

Oscilloscope	HP 1980B
Function Generator	HP 8116A
Spectrum Analyzer	HP 8566A/B

PERFORMANCE TESTS

PROCEDURE: 1. Connect the instruments as shown in Figure 4-13.

Set up the oscilloscope as follows:

Channel A scale:	1.00 volt/div
Channel B scale:	10.0×10^{-3} volt/div
Channel A coupling:	DC
Channel B coupling:	DC
Sweep Time:	1.0 usec sec/div

Set up the function generator as follows:

Function:	Pulse
Frequency:	50 kHz
Amplitude:	1 volt (peak)
Amplitude Offset:	1 volt
Pulse Width:	6 usec

Set up the spectrum analyzer as follows:

Center Frequency:	1000 MHz
Resolution BW:	3 MHz
Frequency Span:	0 Hz
Reference Level:	+20 dBm
Vertical Scale:	Linear

2. Rise/Fall Time

Set the HP 8642 RF frequency to 1000 MHz, amplitude to +13 dBm and turn on external dc pulse modulation. The spectrum analyzer trace should cover the display from the bottom of the CRT nearly to the top. On the Oscilloscope, verify that the recovered modulation pulse on channel B rises from 10% of the final value to 90% of the final value within 3.5 usec. Record the reading below.

Rise Time: _____

PERFORMANCE TESTS

3. On/Off Ratio

Set the spectrum analyzer scale to 10 dB/division. There should be a broad trace that covers the top half of the screen. The top of the trace is the pulse on amplitude and the bottom is the pulse off amplitude; determine the difference in level and verify that the value is within the specified limits given in the table below.

RF Frequency (MHz)	Results	
	Min.	Actual
1000.0	30.0	_____
2000.0	45.0	_____

PERFORMANCE TESTS

4-18. OPTIONAL RESIDUAL FM TEST

SPECIFICATION:

Electrical Characteristics	Performance Limits	Conditions
Residual FM (0.3 to 3 kHz BW)	<5 Hz rms	band 10
	<2	band 9
	<1.2	band 8
	<1	band 1-7
	<3.5	band HET
Residual FM (0.05 to 15 kHz BW)	<9.0 Hz rms	band 10
	<5.0	band 9
	<2.0	band 8
	<1.2	band 1-7
	<5.0	band HET

DESCRIPTION: The 4-8. Residuals Test gives 99% confidence that the HP 8642 is passing all its Residual FM specifications. However, if a measurement bandwidth of 50 Hz to 15 kHz is required, an external LO must be provided (an 8902A measuring receiver must be equipped with option 003 to allow this). The LO must have residual FM lower than or equal to the HP 8642.

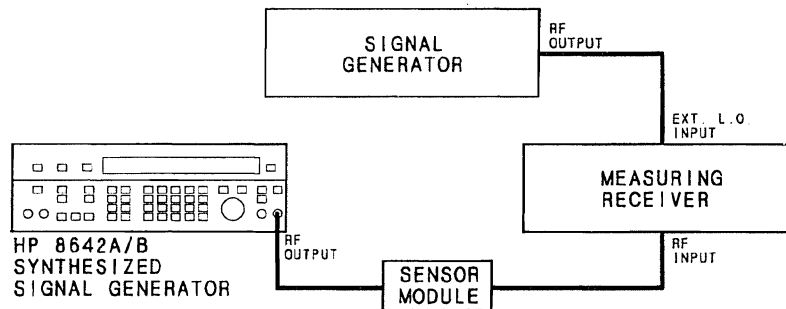

Figure 4-17. Residual Test Setup

EQUIPMENT:

Measuring Receiver	HP 8902A opt 003
Sensor Module	HP 11722A
LO	HP 8662A

PERFORMANCE TESTS

PROCEDURE: 1. Setup

Connect the equipment as shown in Figure 4-17. Preset instruments.

2. Residual FM

Put the measuring receiver in FM mode using the RMS detector and enable the 50 Hz HP Filter and the 15 kHz LP Filter. Set the HP 8642 under test to AMPTD 10 dBm and frequencies in the following table. Set the measuring receiver to 500 MHz. Set the external LO to 1.5 MHz higher than the HP 8642 under test. Verify that the measuring receiver reading is less than the specified maximum.

8642 AMPTD (dBm)	8642 FREQ	Results (kHz)	
		Actual	Max
10	10 MHz	_____	0.0012
10	250 MHz	_____	0.0012
10	0.5 GHz	_____	0.0020
10	1 GHz	_____	0.0050
10	2 GHz	_____	0.0090

PERFORMANCE TESTS

4-19. INTERNAL TIME BASE AGING RATE TEST

NOTE

This test should not be performed unless Option 001 is installed.

SPECIFICATION:

Electrical Characteristics	Performance Limits	Conditions
Aging Rate (Option 001 only)	1×10^{-9} /day	After eight day warm-up (typically 24 hrs in normal operating environment)

DESCRIPTION: The reference signal from the HP 8642 (10 MHz OUTPUT) is connected to the oscilloscope's vertical input. A frequency standard (with long-term stability greater than 1×10^{-10}) is connected to the trigger input. The time required for a specific phase change is measured immediately and after a period of time. The aging rate is inversely proportional to the absolute value of the difference in the measured times.

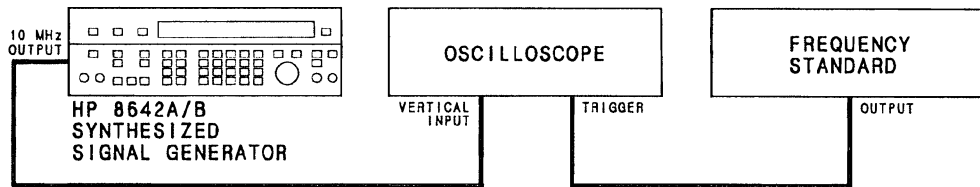

Figure 4-18. Internal Time Base Aging Rate Test Setup

EQUIPMENT:

Frequency Standard	HP 5065A	
Oscilloscope	HP 1740A	

PERFORMANCE TESTS

NOTE

Be sure the HP 8642 has had 10 days to warm up before beginning the test. If the HP 8642 was disconnected from the power line for less than 24 hours, only a 24 hour warm-up is needed.

- PROCEDURE:
1. Set the rear panel REFERENCE switch to INT.
 2. Connect the instruments shown in Figure 4-18.
 3. Adjust the oscilloscope's controls for a stable display of the 10 MHz output.
 4. Measure the time required for a phase change of 360 degrees. Record the time (T1) in seconds.

$$T1 = \text{_____} \text{ s}$$

5. Wait for a period of time (from 3 to 24 hours) and re-measure the phase change time (T2). Record the period of time between measurements (T3) in hours.

$$T2 = \text{_____} \text{ s}$$

$$T3 = \text{_____} \text{ h}$$

6. Calculate the aging rate from the following equation:

$$\text{Aging Rate} = \left(\frac{1 \text{ cycle}}{f} \right) \left(\frac{1}{T1} - \frac{1}{T2} \right) \left(\frac{T}{T3} \right)$$

where: 1 cycle = the phase change reference for the time measurement (in this case 360 degrees)

f = 8642's reference output frequency (10 MHz)

T = specified time for aging rate (24h)

T1 = initial time measurement(s) for a 360 degree (1 cycle) change

T2 = final time measurement(s) for a 360 degree (1 cycle) change

T3 = time between measurement (h)

PERFORMANCE TESTS

for example:

if: T1 = 351s
T2 = 349s
T3 = 3h

then:

$$\begin{aligned} \text{Aging Rate} &= \left(\frac{1 \text{ cycle}}{10 \text{ MHz}} \right) \left(\frac{1}{351\text{s}} - \frac{1}{349\text{s}} \right) \left(\frac{24\text{h}}{3\text{h}} \right) \\ &= 1.306 \times 10^{-11} \end{aligned}$$

7. Record the aging rate.

Aging Rate _____ 5 x 10⁻¹⁰/day

NOTE

If the absolute frequencies of the frequency standard and the HP 8642's reference oscillator are extremely close, the measurement time in steps 4 and 5 (T1 and T2) can be reduced by measuring the time required for a phase change of something less than 360 degrees. Change 1 cycle in the formula (e.g., 180 degrees = 1/2 cycle, 90 degrees = 1/4 cycle).

8. If the rate aging is not within the required tolerance, check the power supplies before replacing A8A3. Be sure sufficient warm-up time has been allowed (may require up to 10 days).

Section 5 ADJUSTMENTS

Table of Contents

Adjustments	5-2
Auto-Adjust Routines	5-2
Description	5-2
How All Auto-Adjust Procedures Begin	5-3
Correction Data Special Functions	5-5
Identifying the Contents of A20	5-5
Identifying the Contents of A3	5-7
Interpreting Cal Data Stats	5-8

5-1. ADJUSTMENTS

If a repair is done by the "Module Exchange" method, no adjustment of the HP 8642 or the exchange module is necessary. If a component level repair is performed on a module, it will be necessary to do its Manual Adjustments and/or Auto-Adjust Procedures to ensure its I/O spec's.

Due to the modular nature of the HP 8642, the adjustment of a module will not effect other modules in the instrument. After the repair of a module, it is only necessary to adjust that module. Therefore, the adjustments have been integrated into the Troubleshooting Information in Section 8.

For example: After two years of operation you find that AM distortion performance is at the extreme limits given in Table 1-1. After using Module Substitution (see On-Site Service Manual) to isolate the problem to A13, you turn to the A13 tab in Section 8. You perform the AM Distortion Adjustment followed by the A13 Auto-Adjust Routine. The AM distortion performance is now returned to nominal.

5-2. AUTO-ADJUST ROUTINES

Description:

In the service documentation for the HP 8642 there will be references to Self-Cal, Self-Calibration, and Auto-Adjust. These three terms refer to the same firmware routines built into the HP 8642 that are used to regenerate module correction data (sometimes referred to as Cal Data). The Cal Data is stored in EEPROM on the A3 board and is used to control the modules during instrument operation. A back-up copy of the Cal Data is stored in EEPROM on the A20 board, which is located under MP 65 on the rear panel.

The Auto-Adjust routines control external measurement equipment via HP-IB for the purpose of regenerating A2, A6, A11, A12, A13, and A14 module correction data, after a component level repair of the module. External measurement equipment required includes; a voltmeter, printer, and HP 8902A. In some cases an HP 8901B may be substituted for the HP 8902A. The printer must have HP-IB capability (such as an HP 2225A). The voltmeter must also have HP-IB capability; an HP 3478, HP 3455 or HP 3456 are some voltmeters that can be used. A list of equipment needed for each Auto-Adjust Routine is given in Table 5-1. At HP 8642 power up, default HP-IB addresses are assumed (see Table 5-2.) If the HP-IB addresses of the external equipment are different from the default values, use the service special functions given in Table 5-2 to re-define the addresses the HP 8642 will use.

Table 5-1. Required Equipment for Auto-Adjust.

Module	HP-IB Printer	HP-IB DVM	HP 8902A
A2	Yes	Yes	No
A6	Yes	Yes	Yes or HP 8901A/B
A11	Yes	Yes	Yes
A12	Yes	Yes	Yes or HP 8901A/B
A13	Yes	Yes	Yes
A14	Yes	No	Yes

Table 5-2. Changing the Default HP-IB Addresses.
(“XX” = New two digit HP-IB address.)

Instrument	Default HP-IB Address	Service Special Function Key Sequence
Printer	01	81 XX Hz
HP 8901A/B, HP 8902A	14	82 XX Hz
DVM	23	83 XX Hz

HP 8642 CONFIGURATION REQUIREMENTS FOR AUTO-ADJUST

To ensure proper operation and accuracy of Auto-Adjust routines the HP 8642 must meet the following minimum configuration.

1. Firmware Date Code must be 850620 or newer. To determine the Firmware Date Code, key in **SHIFT** **SPCL** **2** **4** **9**. The Firmware date Code is displayed in the format "YYMMDD", where "YY" is the last two digits of the year (ie. "85"), "MM" is the number of the month (ie. "06"), and "DD" is the day of the month (ie. "20").
2. A2 Modulation Modules with Serial Prefixes 2714A and above require HP 8642 Firmware Date Code 870601 and above for proper Auto-Adjust operation.
3. The HP 8642 serial number suffix must be greater than XXXXA00200.
4. The HP 8902A used in some of the Auto-Adjust routines must have 32.0 SPCL keyed into it before running the routine if it's firmware date code is 235.1985 or newer. Key 42.0 SPCL into the HP 8902A to display the firmware date code.

NOTE

If an HP 8642 does not have any of the above configuration restrictions and Auto-Adjust difficulties arise, please contact your local Hewlett-Packard Service Center.

How All Auto-Adjust Procedures Begin

At the beginning of each Auto-Adjust routine you are requested to enter data. The Module Tabs in Section 8 contain the Auto-Adjust Procedures, but for the first time user, the beginning of the Auto-Adjust routines is given below with some added explanation.

1. Connect the required equipment to the HP 8642 via HP-IB.
2. Verify or change the HP-IB addresses of the external equipment as previously shown in **Auto-Adjust Routines**.
3. On the HP 8902 (or HP 8901B) insure that: the HP 11722 Cal Factors have been loaded into memory, and the RF Power mode has been Zeroed and Calibrated.
4. Key in: **INST PRESET** on the HP 8642.
5. Key in: **SHIFT SPCL 3** to enter Service Mode.
6. Key in: **8 8 Hz** to make the HP 8642 a system controller.
7. Key in: **8 0 Hz** to initiate the Auto-Adjust mode.

"A BIG HOWDY FROM HP .G0" and "WELCOME TO SELF-CAL .G1" will appear on the display momentarily. (From now on the Back Space key, when used during a data entry prompt, will abort the Auto-Adjust Routine.)

8. "ENTER ROUTINE NUM .G8000" will prompt you to key in one of the routines from Table 5-3. If you have incorrectly entered data, enter an extra digit and then you will be able to re-enter the correct data.

For example: You wanted to enter **9** for the Routine Number but accidentally pressed **8**. Press any numeric key and "INVALID DATA ENTRY .G7002" will appear in the display. Now you can re-enter the **9**. This approach will work with any Auto-Adjust data entry.

Table 5-3. Auto-Adjust Routine Numbers.

Module	Routine Number
A2	9
A6	3
A11	1
A12	2
A13	4
A14	8

9. When "ENTER CURRENT MONTH .G8001" appears, key in a two digit number indicating the month. Then press **[Hz]** to continue.
10. When "ENTER TODAYS DATE .G8002" appears, key in a two digit number indicating the date. (Example: For February 30 you would enter 30.) Then press **[Hz]** to continue.
11. When "ENTER CURRENT YEAR .G8003" appears, key in last two digits of the current year. (Example: For February 30, 1984 you would enter 84.) Then press **[Hz]** to continue.
12. When "ENTER MODULE CAL. ID .G8004" appears, key in last five digits of the Module Cal ID number of the module you are running the Auto-Adjust Routine for. Then press **[Hz]** to continue.

A2 EXAMPLE: The Module Cal ID number is similar to the instrument serial number but appears on the modules. The A2 Module Cal ID number can be found on the ribbon cable connector at the left hand side of the A2 board you will see a label with a number similar to: 2412A/31458. So, you would enter **[3][1][4][5][8][Hz]** for the Module Cal ID number.

13. Now the printer should respond by printing out the statistics of the module. See Figure 5-1. All the information on the print out has been discussed previously, except the Calibration Method number, which will be discussed in Interpreting Cal Data Stats later in this section.

```

MODULATION SECTION (A2) SELF-CALIBRATION

CALIBRATION DATE (MDY): 12/25/86
INSTR. MODEL #: HP 8642B      INSTR. SERIAL #: 2427A00209
INSTALLED OPTIONS: 001
MODULE ID NUMBER: 9      MODULE CALIBRATION ID: 31458
CALIBRATION METHOD: 9995

```

Figure 5-1. Typical Module Stats printout from HP 8642 Auto-Adjust Routine.

14. The remaining steps will be unique to each Module given in Section 8. Turn to the Section 8 Module Tab you are interested in. You will find the complete Auto-Adjust Procedure in the Troubleshooting and Adjustments information. The procedure in Section 8 will include the above less the detailed explanation.

5-3. CORRECTION DATA SPECIAL FUNCTIONS

Identifying the Contents of the A20

The following is a procedure to display and identify the contents of the A20 Board.

1. Switch the HP 8642 to Standby.
2. Plug the A20 on to A3J3.
3. Switch the HP 8642 ON.
4. Key in: **SHIFT** **SPCL** **3** to enter service mode.
5. Key in: **4** **8** **Hz** to display the Module ID numbers corresponding to Valid Cal Data in the A20 Board.

The A20 board can be thought of as having 10 memory locations. The address of each location, (numbered 0 through 9), is the Module ID Number. Each memory location will either contain Valid Cal Data or it will be blank. The A20 addresses that contain Valid Cal Data will now be displayed. Some examples of the HP 8642 display are shown below. Refer to Table 5-4 to cross reference the A20 addresses (Module ID Numbers) to the Memory Contents.

A20 containing HP 8642A Cal Data Backup: **VALID CAL= 01234 6 89 .U619**

A20 containing HP 8642B Cal Data Backup: **VALID CAL= 0123456789 .U619**

A20 provided with A19 exchange module: **VALID CAL= 567 .U619**

A20 provided with A6 exchange module: **VALID CAL= 3 .U619**

⁽ⁿ⁾ A20 containing no data: **VALID CAL= 0 .U619**

Table 5-4. Module ID Numbers.

ID Number	Memory Contents
0	Model #, Serial #, Options
1	A11 Cal Data
2	A12 Cal Data
3	A6 Cal Data
4	A13 Cal Data
5	A19 Doubler Cal Data
6	A16 or A19 Attenuator Cal Data
7	A19 Rev. Pwr. Protect Cal Data
8	A14 Cal Data
9	A2 Cal Data

⁽¹⁾ In a newly initialized A20 board there will be data stored in location 0. The data will be Model #: HP 864--, Serial #: ----- and no options

6. Use the Service Special Functions in Table 5-5 to display the information, referred to as Cal Data Stats, for the Module ID Numbers that were displayed in step 5. See **Interpreting Cal Data Stats** later in this section for details about the display.

Table 5-5. HP 8642 Display for A20 Stats.

Module ID Number	HP 8642 Display	Service Special Function
0	Model #	45 Hz
0	Serial #	46 Hz
0	Options	47 Hz
1	A11 Stats	111 Hz
2	A12 Stats	112 Hz
3	A6 Stats	113 Hz
4	A13 Stats	114 Hz
5	A19 Doubler Stats	115 Hz
6	A16 or A19 Attenuator Stats	116 Hz
7	A19 Rev. Pwr. Protect. Stats	117 Hz
8	A14 Stats	118 Hz
9	A2 Stats	119 Hz

7. If you wish to determine which data is the same between the A20 and the A3, key in . Some examples of the HP 8642 display are:

A20 with A19 exchange module before data down load:

A20 with A19 exchange module after data down load:

A20 with no data corresponding to the HP 8642:

HP 8642A Cal Data Backup:

HP 8642B Cal Data Backup:

Identifying the Contents of the A3

The following is a procedure to display and identify the contents of the A3 Cal Data Memory.

1. Key in: **SHIFT** **SPCL** **3** to enter service mode.
2. Key in: **4** **3** **Hz** to display the Module ID number of any Valid Cal Data in the A3 Board.

The A3 board EEPROM can be thought of as having 10 memory locations. The address of each location, (numbered 0 through 9), is the Module ID Number. Each memory location will either contain Valid Cal Data or it will be blank. The A3 addresses that contain Valid Cal Data will now be displayed. Some examples of the HP 8642 display are shown below. Refer to Table 5-4 to cross reference the A3 addresses (Module ID Numbers) to the Memory Contents.

New A3 before down loading back-up data from A20: **VALID CAL= 0 .U619**

Functional HP 8642A: **VALID CAL= 01234 6 89 .U619**

Functional HP 8642B: **VALID CAL= 0123456789 .U619**

3. Use the key sequence in Table 5-6 to display the cal. data stats for the module(s) you are interested in. See **Interpreting Cal Data Stats** later in this section.

Table 5-6. A3 Cal-Data Stats Display.

ID Number	HP 8642 Display	Service Special Function Key Sequence for A3
0	Model #	40 Hz
0	Serial #	41 Hz
0	Options	42 Hz
1	A11 Stats	11 Hz
2	A12 Stats	12 Hz
3	A6 Stats	13 Hz
4	A13 Stats	14 Hz
5	A19 Doubler Stats	15 Hz ⁽¹⁾
6	A16 or A19 Attenuator Stats	16 Hz
7	A19 Rev Pwr. Protect Stats	17 Hz ⁽¹⁾
8	A14 Stats	18 Hz
9	A2 Stats	19 Hz

⁽¹⁾ If these special functions are used on an HP 8642A "INVALID CHOICE .U670" will appear in the display

Interpreting Cal Data Stats

When viewing the HP 8642 Cal Data Stats you will see the Module ID Number (refer to Table 5-4), the word **STAT**, and three pieces of data. The first field to the right of **STAT** is the Cal Method Number. If the number is 8999, or below the Cal Data was generated at the factory. If the Cal Method Number is 9000 or greater, the Cal Data was generated using one of the Auto-Adjust Routines built into the HP 8642. The second field to the right of **STAT** is the date that the Cal Data was generated. The date is shown in the form month, date, year (MM.DD.YY). The right most field is the five digit Cal ID Number which will conform to the last five digits of the serial-number-like designator (i.e. 2412A/31458) that is on each module.

The following are some examples of the Stats Display on the HP 8642:

09 STAT 9995 02.30.84 31458

A2 Cal Data Stats are: Data generated using the built-in A2 Auto-Adjust Routine February 30, 1984 and the A2 module Cal ID Number is 31458.

02 STAT 0002 12.25.86 00903

A12 Cal Data Stats are: Data generated at the factory on December 25, 1986 and the A12 module Cal ID Number is 00903.

04 STAT 0001 09.06.82 23010

A13 Cal Data Stats are: Data generated at the factory on on September 6, 1982 and the A13 module Cal ID Number is 23010.